

FINISHING BRANDS

PRODUCT CATALOGUE

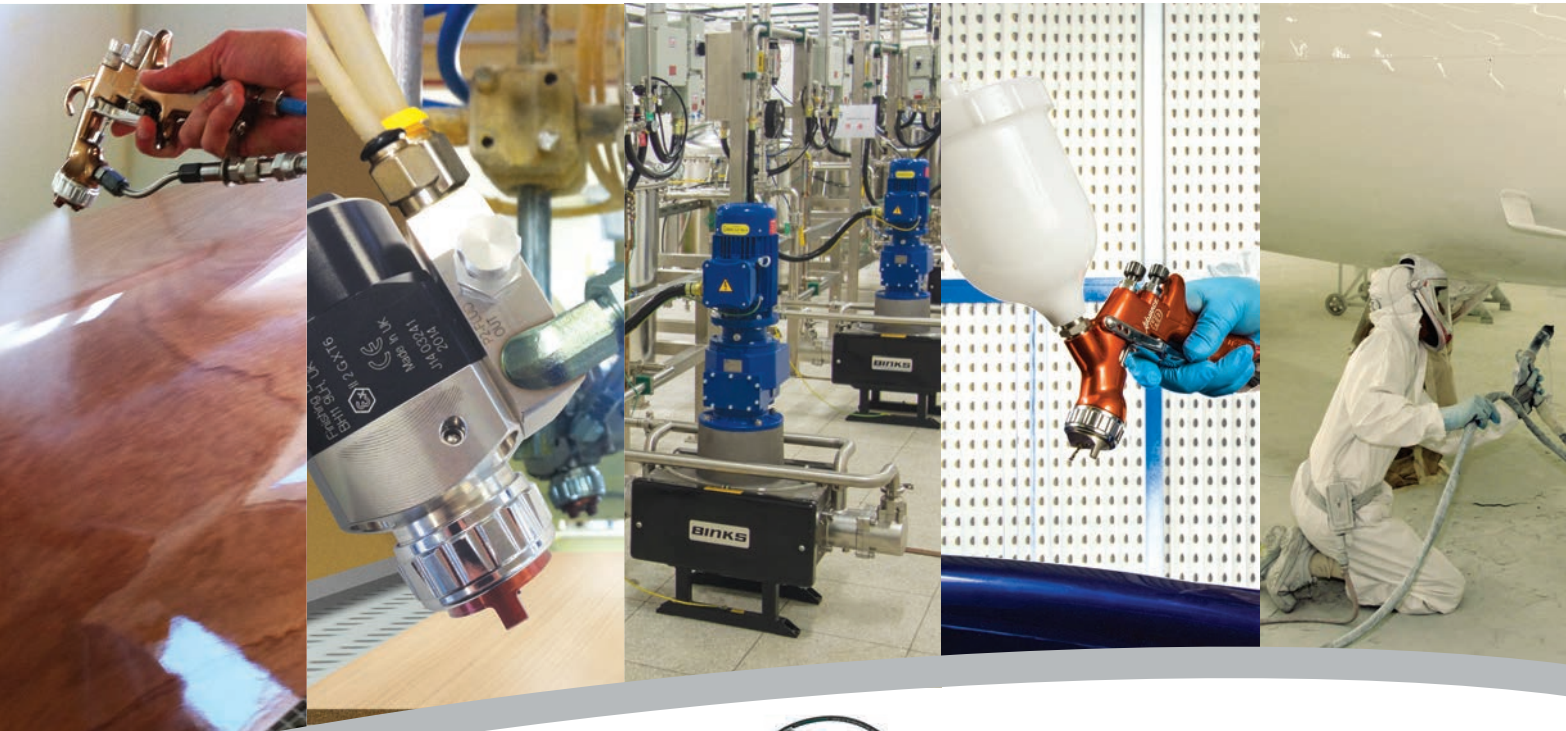

Finishing Solutions for the Global Market



ENGLISH



Finishing Solutions for the Global Market

Finishing Brands Europe based in Bournemouth, England, Dietzenbach, Germany and Valence, France manufacture and supply all types of Industrial Spray Finishing Equipment and accessories.

Incorporating the world leading brands of Binks, Devilbiss and Ransburg produce "cutting edge" high technology Spray Finishing equipment for the supply and application of all sprayed materials for all major manufacturing Industries and Markets. Binks Devilbiss and Ransburg have been manufacturing spray equipment for all of your finishing requirements for over 200 years.

Innovation

The culture of Binks, DeVilbiss and Ransburg is rooted in developing commercial innovations. Many of the product success stories begin on-site, where customers' needs are most apparent. Thanks to the expertise of our management and sales force (many of whom are trained engineers) we are well equipped to provide practical and time-sensitive solutions to the most complex situations. The seasoned workforce intimately understands the manufacturing challenges facing customers and can develop original solutions from the ground up.

Global manufacturing and R&D

Facilities are located in Europe, USA, Australia, Brazil, China, Japan and Mexico with long established Distributors serving all Countries around the World.

We manufacture and supply all types of Spray Finishing Equipment and Accessories. Incorporating the world leading Brands of Binks, DeVilbiss and Ransburg producing "cutting edge" high technology Spray Finishing Equipment for the supply and application of all sprayed materials for all major manufacturing Industries and Markets. This catalogue depicts the range of Binks, Devilbiss and Ransburg Spray Finishing products available from our European sales and marketing operations. This all encompassing product range is itemised in the contents.





For over 125 years the **DeVilbiss** philosophy has been finding innovative solutions to spray finishing problems

Founded in 1888 when Toledo, Ohio physician Dr. Allen DeVilbiss combined a bulb, some tubing, and the base of an oil can to create the first atomiser for health care. DeVilbiss is now the leading supplier of spray finishing equipment to the industrial and automotive markets.

Since then, DeVilbiss has maintained its commitment to innovative technology by establishing itself as a team of experts who thoroughly understand the intricacies of the finishing process, the equipment design needed for achieving the highest quality finish, and the bottom line needs of customers to maximise productivity.

Ransburg, the acknowledged leader in electrostatic painting processes

Harold Ransburg developed the first electrostatic application system in 1940 with the introduction of Ransburg No1. Further developments through the 50s and 60s lead to Ransburg achieving material transfer efficiency levels of up to 98% and significant reductions in overspray, resulting in dramatic cost savings and reduced VOC emissions in a wide range of applications, in many different industries.

Today Ransburg is acknowledged as the market leader in the design and manufacture of electrostatic equipment. Its cutting edge technology has led to the development of rotary atomisers like bells and discs.

Binks working in virtually every industry around the world

In 1890, Joseph Binks pioneered the spray gun industry with the introduction of the first cold-water paint spraying machine. It all started in the basement of Marshall Field & Company, when Joseph Binks figured out how to spray the walls instead of brushing them, and saved a lot of time.

Binks used his invention to rescue the opening of the 1896 Colombian Exposition. Just days before the opening, nine of ten exhibit buildings stood unpainted, but Binks saved the day. Today you can find spray finishing technology from Binks at work in virtually every industry around the world.





Fully Approved Distributors offer the Highest Standards of Sales and Service of Binks, DeVilbiss and Ransburg products

After thorough evaluation of how best to serve our customers, established distributors have proved by far the best method of achieving this goal. Our Distributors are strategically selected, they understand local industries and their specific finishing requirements. What's more they have the facilities coupled with in-depth product knowledge and experience that we know our customers really value.

Proven to be the best

Our distributors are carefully selected and have met our exacting criteria. To qualify, a Distributor must agree to a comprehensive range of business improvements including: a highly efficient parts and service operation, specialist staff training to ensure expert product knowledge, the provision of technical support and implementation of approved management systems.



Manual and Automatic Spray Guns

Manual Spray Guns	DeVilbiss	10
Automatic Spray Guns	Binks/DeVilbiss	17
Manual Airless and Air Assisted Spray Guns	Binks	21
Automatic Airless and Air Assisted Spray Guns	Binks	23

Electrostatic Spray Guns

Electrostatic Manual Spray Guns	Ransburg	26
Electrostatic Manual and Automatic Electrostatic Applicators	Ransburg	30
Electrostatic Power Supplies and Controllers	Ransburg	32
Electrostatic 2k Plural Component Paint Mixing Machines	Ransburg	33
Electrostatic Fluid Handling	Ransburg	34
Reciprocators	Ransburg	35

Pumps and Fluid Handling Equipment

High Pressure Paint Pumps	Binks	38
Low Pressure Paint Pumps	Binks	39
Diaphragm Pumps	Binks	42
Maple Pumps	Binks	45
Electric Paint Circulating Systems Pumps	Binks	46
Paint Circulating Systems Equipment	Binks/Ransburg	47
RAM Units	Binks	50
Electronic 2k Plural Component Paint Mixing Machines	Binks	51
Pressure Feed Containers	Binks	52
Pressure Feed Cups	Binks/DeVilbiss	54
Agitators and Elevators	Binks	55
Fluid Regulators	Binks	57
Air Filter Regulators	DeVilbiss	58
Air/Fluid Hoses and Connectors	Binks/DeVilbiss	60
Spray Booth Filter Paper	Binks	62
Air Fed Visors and Masks	DeVilbiss	64
Spray Equipment Accessories	Binks/DeVilbiss/Ransburg	66
Service Kits	Binks/DeVilbiss	68
Operator Training Support		70
On-time deliveries and keeping you informed		71

Substrate indicators guide users where our products can be applied:

- 1 Tips/needles = Stainless Steel as standard
- 2 Stainless Steel fluid passageways
- 3 Optional = Tungsten Carbide and hardened tips/needles
- 4 Substrate = Wood, metal, plastic and others
- 5 Substrate = Ceramic and glaze





Finishing Brands Integrated Solutions

With over 200 years of experience in paint application, fluid handling and surface coating technology, Finishing Brands has an unprecedented depth of knowledge and experience in systems design and installation : a resource which is now being made available to our distributors and customers through our Integrated Solutions division based in Germany. Finishing Brands Integrated Solutions provide a full systems consultancy, design and installation service to customers requiring turn-key solutions or the upgrade of existing systems. Utilising our high quality, fluid handling and paint application products and backed up by our highly experienced and knowledgeable team, you can be sure that any system project we undertake will be competitively priced, built to last and will provide real and sustainable return on investment.

Our team is made up of a backbone of seasoned Finishing Brands engineers all with considerable experience in paint systems development and management. We also work closely with our network of approved local partners on both the installation project itself and to ensure continued local support and service to our customers.

Finishing Brands Integrated Solutions Division can help you by:

- Providing a paint systems consultancy, design and installation service for turn-key systems utilising cutting-edge automated and manual spray finishing and fluid handling equipment.
- Managing your new system installation project from consultancy and design to full production switch-on, with back-up support and service thereafter.
- Evaluating your existing installation to provide guidance on refurbishment and retrofits including possible efficiency gains, energy and paint savings and the implementation of new technology.
- Testing and demonstration of new products and techniques at our test laboratory in Dietzenbach.
- Evaluation of new paint and fluid products and how they will perform in existing fluid circulating and application systems.

For further information, talk to your Finishing Brands representative or contact the Integrated Solutions team at our Dietzenbach facility in Germany.





Bournemouth Facility



Valence Facility



Dietzenbach Facility



Manual and Automatic spray guns

Leading the way with spray gun Innovation

Binks and DeVilbiss invented the world's first "stand alone" HVLP and COMPLIANT technology spray guns back in the 1980's, resulting in a revolution in the way our spray guns atomise paints to provide the bench mark in paint transfer efficiencies, saving paint for the end users and dramatically reducing the emission levels of harmful VOC's into the atmosphere. These and other patented ground breaking product developments have placed Binks and DeVilbiss as the foremost spray equipment manufacturer for many years.

DeVILBISS

Manufactures low pressure manual and automatic spray guns and related spraying accessories; including air filter reducing valves and regulators, operator breathing systems, spray gun cups, hoses and other equipment for the Finishing Markets. DeVilbiss is widely recognised for the development and introduction of the first "Compliant" spray guns, which greatly reduce overspray and VOC's into the environment. An expertise in ergonomics and innovative spray gun design is widely acclaimed.

BINKS

Manufactures low and high pressure manual and automatic spray guns, accessories, airless and air assisted airless spray painting outfits; high and low pressure fluid handing pumps and regulators, pressure feed tanks, 2K electronic paint mixing machines and paint circulating systems for the industrial finishing and automobile manufacturing markets.

A pioneer in spray finishing technology which includes the development and introduction of the world's first "stand alone" HVLP spray guns.

Here is an explanation of the atomising technologies used throughout this product catalogue.

CONVENTIONAL "AIR SPRAY" ATOMISATION

The most established method of air atomising used on "conventional" spray guns, uses relatively high velocity compressed air to provide good atomisation of the sprayed material. However this process results in low paint transfer efficiencies due to the 'bounce-back' and 'overspray' generated. Compressed air operating pressures used in this process are typically 2 to 4 BAR (30 to 60 psi).

HVLP (HIGH VOLUME LOW PRESSURE)

This "compliant" atomisation method first became important in the 1980's when environmental legislation was first introduced. It uses larger compressed air volumes at lower pressures to atomise the coating. It has a much higher transfer efficiency than Conventional Air Spray. However, the droplet size produced tends to be slightly larger, sometimes resulting in a lower quality finish. HVLP operates at 0.7 BAR (10 psi) at the air cap in compliance with global environmental legislation to provide greater than 65% transfer efficiencies.

TRANS-TECH® (COMPLIANT)

This atomisation type was introduced by DeVilbiss in the mid 1990's and is a ground breaking combination of Conventional and HVLP atomisation methods. Trans-Tech utilises more compressed air energy for the atomisation process producing much higher Transfer Efficiency of coating material than the Conventional method. This 'complies' with Global legislation by being able to transfer at least 65% of the sprayed material to the component. Air Cap Pressure is

typically 1.3 to 3 BAR (20 to 45 psi). HVLP has mostly been replaced by DeVilbiss Trans-Tech Atomisation in most applications due to its superior finish qualities.

AIRLESS SPRAY

Airless spraying is a method of spray application that does not directly use compressed air to atomise the paint/coating material, hence the terminology "Airless". Hydraulic fluid pressure is used to atomise the paint by pumping it at high pressures of about 30 to 450 BAR (500 to 6500 psi) through a small orifice spray nozzle (typically tungsten carbide). The resulting spray atomisation is ideal for the very fast application of protective and decorative coatings. Typical applications include corrosion protection of large steel components and structures, and the interior of buildings.

AIR ASSISTED AIRLESS

The paint/coating material is hydraulically forced through a small orifice spray nozzle (tungsten carbide) with a typical fluid pressure of 25 to 120 BAR (400-1800 psi). Final atomisation and fan shaping air is then added by the Binks HVLP/Compliant air cap blending with the fluid stream to produce an exceptionally fine and even spray pattern with very little overspray. This unique combination of Air Assisted Airless/HVLP technologies results in a finely atomised "soft spray" pattern producing a high quality finish that particularly lends itself to finishing wooden products that need an exceptionally fine finish with greatly reduced overspray in compliance with worldwide VOC regulations.

Innovation and Technical Excellence

Global Leaders

DeVilbiss and Binks the globally acknowledged leaders in spray gun and air cap design, have pioneered and perfected paint atomisation technology innovations, to ensure the highest possible standards in paint application and finish. The manual and automatic spray guns depicted in this section are evidence of the continual commitment to product excellence from the world leaders in spray gun manufacturing.

Research and Development

Huge resources are dedicated to research and development. We work closely with the leading paint companies and specialists in surface coatings to ensure our equipment consistently provides the standard of finish our customers demand.

Atomisation Technologies

DeVilbiss and Binks manual and automatic spray guns utilise Conventional, HVLP, Trans-Tech Compliant, Airless and Air Assisted Airless atomisation technologies to apply a wide range of coatings. (For a detailed explanation of these technologies see page 8 and for electrostatic technologies page 24).

Applications

- Aircraft and Aerospace Industry
- Automotive (OEM and Tier 1)
- Agricultural and Farming Machinery
- Furniture Manufacturers (Wood and Metal)
- General Industry
- Leather Goods and Shoe Makers
- Defence and Military Fighting Vehicles
- Potteries (Glaze)
- Trade Coaters - Stove Enamellers
- Marine and Boating Industry
- Woodworking and Joinery
- Truck and Bus
- Rail and Transport
- Off Road Vehicles – fork lift trucks, plus many others

Compatible Material/Coating Types

- Solvent and Water Based Materials
- Compliant/High Solids Coatings
- Adhesives
- Primers, Enamels and 2K Polyurethanes
- Fillers, Sealers and Lacquers
- Cellulose
- Pre-Catalysed
- Acid Catalysed
- U.V. Curing Sealers and Topcoats
- Stains and Varnishes
- Release Agents
- Twin Pack Materials (2K)
- Anticorrosive Paints, plus many others



ADVANCE HD HVLP AND TRANS-TECH
PRESSURE, GRAVITY AND SUCTION MANUAL SPRAY GUNS



The all purpose mid-sized Compliant spray gun range

- Robust, Lightweight and work friendly design for High Demand outputs
- Balanced air valve design for lighter trigger pull and improved air flow
- Trans-Tech Compliant and HVLP air caps provide superior finish with the best possible paint savings and transfer efficiency
- Contoured handle design – Greatly reduces RSi and operator fatigue
- Stainless Steel tips, needles and fluid passageways as standard
- CE marked and fully ATEX approved.

The comprehensive Advance HD (High Demand) spray gun range ensures there's a DeVilbiss spray gun to suit all types of industrial spray finishing applications. Pressure, Suction and Gravity feed, the Advance HD family utilise a comprehensive, wide range of Compliant Air Caps to provide outstanding coatings' atomisation for handling all types of solvent, waterborne, high solids and 2K materials.

DeVilbiss expertise and performance unequalled at work...

Advance HD unrivalled high performance is achieved with new design technology utilising high capacity air passages with a separate "balanced" air valve to provide an unrestricted flow of compressed air through the gun body. This "free breathing" air movement enables the precision-engineered air caps and fluid tips to produce superior atomisation with consistent even distribution throughout the spray pattern. Advance HD is precision built using the best materials and component parts for a guaranteed, reliable, long and durable working life in all industrial markets.



Key features and benefits for



- "Trans-Tech" Compliant, HVLP or Conventional Air Caps, St St Fluid Tips and Needles with Hardened and tungsten carbide options provide universal compatibility with ALL Industrial Spray Coatings.
- Stainless Steel Fluid passageway/inlet with 3/8" Universal Thread for BSP and NPS compatibility.
- No Baffle design – reduced number of parts, reducing weight and making cleaning easier.

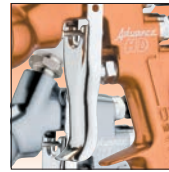

- Increased "Finger" Space – Easier operator access.
- Lighter Trigger Pull Tension – Decreased RSi and Operator Fatigue.
- Self adjusting Needle Packing Assy – PTFE.
- Comfortable operator friendly Trigger design – with reduced trigger travel.

DeVilbiss Advance HD has a very wide selection of fluid and air nozzles to provide outstanding atomisation over a wide range of materials including high solids, solvent/waterborne paints, lacquers, stains, glaze, base and clear coats, twin pack and many other finishing materials.

Example of gun part numbering:-
ADV-P522-14 =

- ADV = Advance gun
- P = Pressure
- 522 = TRANS-TECH Air Cap
- 14 = 1.4mm Fluid Tip and Needle.

Advance HD spray guns kits are packaged as :- Pressure gun only, Suction gun with 1 litre cup and Gravity feed kits inc. 568 ml standard gravity cup or gravity Pressure kits inc 568 ml polyester cup.

Air Cap Number and Type	Air Consumption	Air Inlet Pressure Bar (psi) recommended	*Typical Fluid Flow ml	*Typical Fan Pattern size mm
No. 500R (HVLP)	195 l/min (7 scfm)	1.0 bar (14 psi)	130-190	Round spray
No. 505 (HVLP)	385 l/min (13.6 scfm)	1.3 bar (19 psi)	130-190	270
No. 590 HV (HVLP)	200 l/min (7.1 scfm)	1.0 bar (14 psi)	0-150	120
No. 510 Trans-Tech	283 l/min (10 scfm)	2 bar (29 psi)	160-220	270
No. 513 Trans-Tech	394 l/min (14.1 scfm)	2 bar (29 psi)	200-800	350
No. 515 Trans-Tech	364 l/min (12.9 scfm)	2 bar (29 psi)	200-400	320
No. 520 Trans-Tech	284 l/min (10 scfm)	2 bar (29 psi)	150-250	280
No. 522 Trans-Tech	410 l/min (14.5 scfm)	2 bar (29 psi)	200-600	350
No. 523 Trans-Tech	410 l/min (14.5 scfm)	2 bar (29 psi)	200-400	300
No. 590 Trans-Tech	218 l/min (7.8 scfm)	2 bar (29 psi)	0-150	150
No. 591 Trans-Tech	218 l/min (7.8 scfm)	2 bar (29 psi)	0-150	150

No. 505 (HVLP) and No. 500R (HVLP) air caps operate at 0.7 bar (10 psi) at the cap. All illustrated flow rates and fan sizes may vary according to paint/material viscosity and pressures used.

Fluid Tip and Cap Chart

Air Cap No.	Technology	0.5 mm	0.7 mm	0.85 mm	1.0 mm	1.2 mm	1.3 mm	1.4* mm	1.6 mm	1.8* mm	2.0 mm	2.2* mm
500R	HVLP			P	P	P	PG	P	PGS	PGS	PGS	PGS
505	HVLP			P	P	P	PG	PG	PGS	PGS	PGS	PGS
590HV	HVLP	P	P		P							
510+	Trans-Tech			P	P	P	PG	PG	PGS	PGS	PGS	PGS
513	Trans-Tech			P	P	PG	PG	PG	PGS	PGS	PGS	PGS
515	Trans-Tech			P	P	P	P	P	P	P	P	P
520	Trans-Tech			P	P	PG	PG	PG	PGS	PGS	PGS	PGS
522	Trans-Tech			P	P	P	P	P	P	P	P	P
523	Trans-Tech			P	P	P	P	P	P	P	P	P
590	Trans-Tech	P	P		P							
591	Trans-Tech	P	P		P							

P = Pressure G = Gravity S = Suction * Hardened & tungsten carbide tips and needles are available in these sizes.

MANUAL SPRAY GUNS

ADVANCE HD CONVENTIONAL
PRESSURE, GRAVITY AND SUCTION MANUAL SPRAY GUNS

The all purpose mid-sized Conventional spray gun range

- Wide range of conventional atomisation air caps provide a superior sprayed finish
- Robust, Lightweight and work friendly design for High Demand outputs
- Stainless Steel tips, needles and fluid passageways as standard
- Contoured handle design – Greatly reduces RSi and operator fatigue
- CE marked and fully ATEX approved.

Advance HD – Naturally comfortable...

Light weight with a lighter trigger action and increased finger room. Advance HD is perfectly balanced and naturally comfortable thanks to the fit and feel of the contoured handle design. It greatly reduces operator fatigue and significantly lessens the chances of RSi or finger problems. Comfort that pays off by increasing productivity wherever DeVilbiss Advance spray guns are used, whether it's a small finishing operation or a high volume production line.

DeVilbiss outperforms the rest.

Advance HD's unique high capacity airflow and outstanding atomisation characteristics are combined with a separate "balanced" air valve to provide an unrestricted flow of compressed air through the gun body, this coupled with light, feel right comfort is an unbeatable combination.

Advance spray guns are ideal for small operations or high volume spraying, with the added bonus of instantly improved finishing productivity.

The DeVilbiss Advance HD (High Demand) spray guns are available in Pressure, Suction and Gravity feed formats and a wide range of conventional technology Air Caps provide exceptional atomisation for coating wood, metal, plastic, ceramic and composite substrates with most types of solvent, waterborne, high solids and 2K materials.

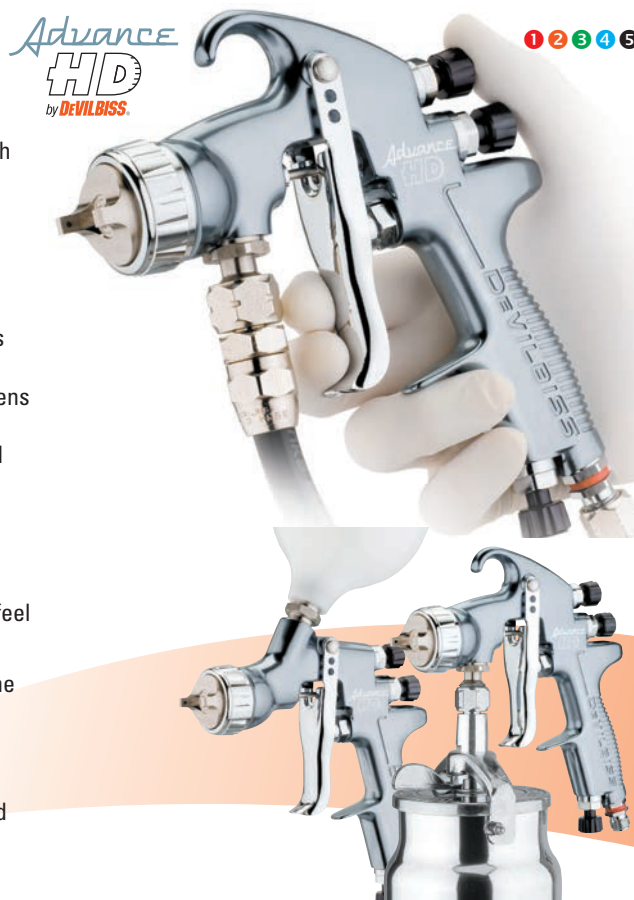

High Demand applications

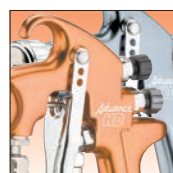

- Forged Aluminium Alloy Gun Body – Heavily Anodised for a Rugged Long working life.
- Wider Hook opening 1/2" (12mm).
- Gun Controls – Easy Adjustment for precise control of Fluid output and atomising air.
- Separate "balanced" Air Valve design for precise air flow triggering and easier cleaning.

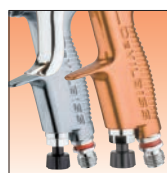

- Curved Handle design – provides superior operator fit and feel with reduced RSi and operator fatigue.
- Air Inlet Adjuster "Cheater" valve included as standard.
- 1/4" Universal Thread air inlet.

Optional accessories for Advance HD Spray Guns

1. VSA-512 St/St Fluid Filter Kit (inc. 3 elements)
2. Tungsten Carbide and Hardened Tips/Needles (for use on abrasive materials)
3. Nylon Tipped Needle. 1.0, 1.2 and 1.4



Suction cup pt. no. KR-566-1-B



Gravity cup pt. no. GFC-501



Gravity cup (Blue polyester) pt. no. GFC-511 for difficult fluids

Air Cap Number and Type	Air Consumption	Air Inlet Pressure Bar (psi) recommended	*Typical Fluid Flow ml	*Typical Fan Pattern size mm
No. 430 Conventional	339 l/min (12 scfm)	3.5 bar (50 psi)	200-280	200
No. 443 Conventional	345 l/min (12.3 scfm)	3 bar (45 psi)	200-300	300
No. 462 Conventional	380 l/min (13.5 scfm)	3 bar (45 psi)	500-3000†	450†
No. 470 Conventional	465 l/min (16.4 scfm)	3 bar (45 psi)	500-1800†	420†
No. 477 Conventional	480 l/min (17 scfm)	3 bar (45 psi)	200-800	430
No. 497 Conventional	510 l/min (18 scfm)	3.5 bar (50 psi)	200-600	380

All illustrated flow rates and fan sizes may vary according to paint/material viscosity and pressures used.

† = ceramic material

Fluid Tip and Cap Chart

Air Cap No.	Technology	0.85 mm	1.0* mm	1.2* mm	1.3 mm	1.4* mm	1.6* mm	1.8* mm	2.0 mm	2.2* mm	2.8* mm
430	Conventional	P	P	PG	PG	PGS	PGS	PGS	PGS	PGS	
443	Conventional	P	P	PG	PG	PS	PS	PGS	PGS	PGS	
462	Conventional									P†	P†
470	Conventional									P†	P†G
477	Conventional	P	P	P	P	P	P	P	P	P	
497	Conventional	P	P	P	P	P	P	P	P	P	

P = Pressure G = Gravity S = Suction * Hardened and/or tungsten carbide tips and needles are available in these sizes.

Spray Gun Extension's

See page 20 for the complete range



See page 69 for Service Kits.

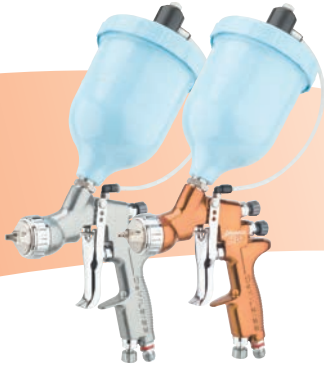

ADVANCE HD GRAVITY SPRAY GUN WITH PRESSURE ASSISTED CUP



DeVilbiss Advance HD pressure assist gravity cup system is perfect for the application of heavily bodied thixotropic materials. DeVilbiss Advance HD pressure assist spray guns are available in both Compliant and Conventional atomisation technologies. Advance HD is precision built using the best materials and component parts for a guaranteed, reliable, long and durable working life in all markets.

- Faster application rates of high viscosity materials
- Robust, Lightweight and work friendly design for High Demand outputs
- Renowned DeVilbiss Atomisation Quality
- Compliant and Conventional spray guns
- Contoured handle design – Greatly reduces RSi and operator fatigue
- Stainless Steel tips, needles and fluid passageways handle Solvent and Waterbased materials
- Polyester gravity cup for all types of materials.

Specifications and Technical Data	
Air Supply Connection	Universal 1/4" BSP and 1/4" NPS male
Maximum Air Inlet Pressure	P1 = 12 bar (175 psi)
Service Temperature	0 to 40°C (32 to 104°F)
Gun Weight (gun only)	482 g
(with cup)	680 g

Air Cap Number and Type	Air consumption	Air inlet pressure bar (psi) recommended	*Typical Fluid Flow ml	*Typical Fan Pattern size mm
No. 510 Trans-Tech	283 l/min (10 scfm)	2 bar (29 psi)	160-220	270
No. 513 Trans-Tech	394 l/min (14.1 scfm)	2 bar (29 psi)	200-800	350
No. 520 Trans-Tech	283 l/min (10 scfm)	2 bar (29 psi)	150-250	280
No. 430 Conventional	339 l/min (12 scfm)	3.5 bar (50 psi)	200-280	200
No. 443 Conventional	345 l/min (12.3 scfm)	3 bar (45 psi)	200-300	300

*Fluid tip range 1.3, 1.4, 1.6, 1.8, 2.0 & 2.2mm.



DEVILBISS PRO LITE MANUAL SPRAY GUN RANGE



Professional spray equipment for Fine Finishing.

DeVilbiss expertise and performance unequalled at work...

The GTi PRO Lite spray gun family ensures there's a DeVilbiss spray gun to suit all types of spray finishing applications.

Pressure, Suction and Gravity feed, the range utilises a comprehensive range of new development Air Caps and fluid nozzles to provide outstanding atomisation for handling all types of Industrial solvent based and waterbased coatings.

The PRO Lite is precision built using the highest quality materials and component parts for a guaranteed, reliable, long and durable working life in all markets. A drop forged aluminium body with tough anodised external finish, high grade stainless steel fluid tips and needles and nickel plated hard brass air caps all contribute to a gun that can last in the extreme environment of the spray shop. When routine maintenance is needed then the simple design and easy to maintain format ensures

- minimum down time and interrupted production.
- Enhanced ergonomics combined with DeVilbiss' legendary fit and feel ensure incredible performance, handling and balance.
- Comprehensive range of Conventional, HVLP and Trans Tech (High Efficiency) Air Caps for choice of Transfer Efficiency, Atomisation power and Application requirements.
- Extensive range of stainless steel, hardened and tungsten carbide fluid tips and needles for all types of industrial applications.
- Coaxial trigger air valve design for lighter trigger pull and improved air flow.
- Drop forged aluminium gun body and removable air baffle for a longer working life.
- Fully Environmental Legislation Compliant with high transfer efficiency resulting in significant paint savings.
- Air adjuster valve provides instant "on gun" pressure adjustment for the sprayer.
- Fully ATEX certified and authorised for use in the EU community.

The Pro Lite gun is also available with "locked" gun controls for automotive applications.

Air Cap and Fluid Nozzle Options for Gravity GTi PRO Lite (used with PRO-200 series Fluid Tips)

Air Cap	Atomisation Type	0.85 mm	1.0 mm	1.2 mm	1.3 mm	1.4 mm	1.6 mm	1.8 mm	2.0 mm
HV30	HVLP			S	S	S	S	S	S
TE10	Trans Tech (High Efficiency)			S	S	S	S	S	S
TE20	Trans Tech (High Efficiency)			S	S	S	S	S	S

Air Cap and Fluid Nozzle Options for Suction GTi PRO Lite (used with PRO-200 series Fluid Tips)

Air Cap	Atomisation Type	0.85 mm	1.0 mm	1.2 mm	1.3 mm	1.4 mm	1.6 mm	1.8 mm	2.0 mm
HV30	HVLP						S	S	S
TE10	Trans Tech (High Efficiency)						S	S	S
TE20	Trans Tech (High Efficiency)						S	S	S

Air Cap and Fluid Nozzle Options for Pressure GTi PRO Lite Spray guns (used with PRO-205 series Fluid Tips)

Air Cap	Atomisation Type	0.85 mm	1.0 mm	1.2 mm	1.3 mm	1.4 mm	1.6 mm	1.8 mm
HV30	HVLP	S	S	S		S	S	S
TE10	Trans Tech (High Efficiency)	S	S	S		S	S	S
TE20	Trans Tech (High Efficiency)	S	S	S		S	S	S
TE30	Trans Tech (High Efficiency)	S	S	S		S	S	S
TE40	Trans Tech (High Efficiency)	S	S	S		S	S	S
TE40R	Trans Tech (High Efficiency)	S	S	S		S	S	S

S = High Quality Stainless Steel Tips and Needles available in this type and size
 N = Nitride Hardened Tips and Needles also available in this type and size
 C = Tungsten Carbide Tips and Needles also available in this type and size



DEVILBISS PRO LITE E CERAMIC AND ENAMEL INDUSTRY HAND GUN

The DeVilbiss PRO Lite E is an enhanced version of the PRO lite exclusively designed for heavy duty spray finishing and surface coating applications in the ceramic and vitreous enamel market.

The combination of highly abrasive coatings plus high fluid flow rates present particularly difficult conditions for application equipment, and the DeVilbiss PRO Lite E has been designed for continuous and reliable performance in this environment.

The standard gun body forging is first coated with our specially developed Quickclean™ coating to reduce cleaning time and improve durability even more. Then the coated gun body is machined and fitted with a fluid passageway liner so that the fluid only ever touches stainless steel taking away any concerns regarding corrosion or fluid incompatibility.



Finally the gun is fitted with a special abrasion resistant needle packing to withstand the aggressive action of ceramic coating on the sliding needle shaft.

- The perfect gun for enamel, ceramic and glaze applications with drop forged aluminium body, Quickclean™ black gun body coating and specialised needle packing for a longer working life.
- Comprehensive range of Conventional Air Caps.
- Extensive range of stainless steel, hardened and tungsten carbide fluid tips and needles for all types of ceramic applications.
- Increased diameter Stainless Steel large bore Fluid Passageways for fluid flows up to 3.5 L/min with heavy weight ceramic glaze.

Conventional Air Caps for Pressure PRO Lite E hi-flow ceramic coating applications (used with PRO-250 series Fluid Tips)

Air Cap	Atomisation Type	1.4 mm	1.6 mm	1.8 mm	2.0 mm	2.2 mm	2.8 mm
C62	Conventional						S N C
C64	Conventional					S N C	
C67	Conventional	S N		S N C			

S = High Quality Stainless Steel Tips & Needles available in this type & size

N = Nitride Hardened Tips & Needles also available in this type & size

C = Tungsten Carbide Tips and Needles also available in this type & size

PRO Lite E spray gun is for use on Ceramic/Enamel water based materials only.

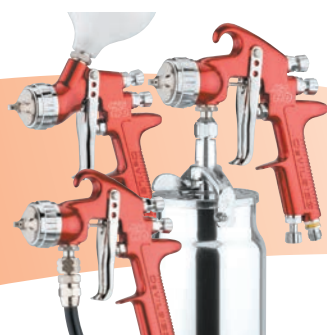

JGA AND GFG HD CONVENTIONAL PRESSURE, GRAVITY AND SUCTION MANUAL SPRAY GUNS



The Finishing World's favourite spray guns just got better with the introduction of the HD (High Demand) range.

The DeVilbiss JGA & GFG HD are high performance conventional air atomising guns suitable for most spray finishing applications and are made of the best available materials to withstand the highest demands in the modern spray shop, to provide a guaranteed, long and durable working life. The guns can be used with virtually all solvent and water based paints,

coatings, lubricants, dyes, stains, varnishes, lacquers and adhesives.

The 'full size' Conventional spray gun range

- Renowned DeVilbiss Atomisation Quality
- Genuine fast application rates
- Forged aluminium gun body for long life service
- Light smooth trigger action to reduce operator fatigue
- Balanced air valve design to improve air flow characteristics.

Example of gun part numbering:-
JGAPHD-C3-10 means...

JGAPHD = JGA Pressure Gun HD

C3 = C3 Air Cap /

10 = 1.0 mm Fluid tip and needle.

Air Cap Number and Type	Recommended Inlet Pressure	Air Flow @ 3 bar/43.5 psi
C1 Conventional Gravity/Suction/Pressure	2.5-3 bar (36-44 psi)	250-300 l/min (9-11 scfm)
C2 Conventional Gravity/Suction/Pressure	2.5-4 bar (36-58 psi)	255-400 l/min (9-14 scfm)
C3 Conventional Pressure	2.5-4 bar (36-58 psi)	260-410 l/min (9-15 scfm)

Specification	JGA HD	GFG HD
Air Connection	1/4" Universal	1/4" Universal
Fluid Connection	3/8" Universal	N/A
Gun Weight (without cup)	650 g	585 g

Air Cap No.	Tip size	0.85mm	1.0 mm	1.2 mm	1.4 mm	1.6 mm	1.8 mm
C1		P	P	P	P	P G S	P G S
C2		P	P	P	P G	P G S	P G S
C3		P	P	P	P	P	P

P = Pressure G = Gravity S = Suction

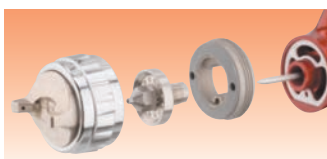



PRI HD
GRAVITY MANUAL SPRAY GUN



DeVilbiss PRI HD –

The ultimate in primer spray gun technology

The PRI HD is a compliant gravity feed spray gun specifically designed for the application of modern primers, surfacers and fillers. The P1 primer air cap incorporates the latest DeVilbiss Trans-Tech atomisation technology for total compliance with EPA regulations. Primer guns must be compliant in their own right. The P1 air cap is manufactured in plated brass for ultimate durability.

The all purpose full size Compliant primer spray gun

- Large spray patterns and even material distribution
- Suitable for all types of primers, surfacers, fillers and polyesters
- Air adjuster valve on the gun handle allows instant pressure control
- Balanced air valve design for lighter trigger pull and improved air flow
- Tough and durable drop forged aluminium gun body
- Paint cup includes integral filter and drip-check lid.

**Example of gun part numbering:
PRIHD-P1-14 =**

- PRIHD = PRI HD Gravity Gun
- P1 = P1 Air Cap
- 14 = 1.4 Fluid Tip and Needle.

Specification	PRI HD Gravity
Air Connection	1/4" Universal
Gun Weight (without cup)	585 g

Air cap Number and Type	Recommended Inlet Pressure	Air Flow @ 2 bar/29 psi
P1 Trans-Tech Gravity	2 bar (29 psi)	300 l/min (11 scfm)

PRI HD Gravity Fluid Tip/Needle (mm) size and code: 1.4, 1.6, 1.8, 2.0, 2.5

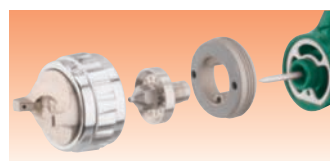

**Optional accessories
for Pro Lite, JGA and PRI
Spray Guns**

VSA-512 St/St Fluid Filter
Kit (inc. 3 elements)



Suction cup pt. no.
KR-566-1-B



Gravity cup pt. no.
GFC-501



Gravity cup (Blue polyester)
pt. no. GFC-511 for difficult fluids

See page 69 for Service Kits.



DEVILBISS SRI PRO
THE ULTIMATE HIGH PRECISION TOUCH-UP AND SPOT REPAIR GUN

The Devilbiss SRI Pro Lite is the ultimate high precision spray gun providing superb feathering control combined with the pattern range and versatility needed for top quality finishing including spot repairs, shading and stencilling, whilst providing excellent comfort stability balance and delicacy of control. A new edition to the range is the SRI Pro Lite Micro which has been custom built for the high precision techniques used in the growing field of micro repairs.

provide superb atomisation of both solvent and waterbased materials.

- A small scale high precision spray gun with many practical uses throughout automotive and general industry, ergonomically styled for comfort
- Choice of HVLP or Trans-Tech compliant air caps

- Critically engineered Stainless Steel fluid tips & needles give ultimate feathering control
- Balanced air valve design for lighter trigger pull and improved airflow
- Lightweight strong cast aluminium gun body
- Reduced needle spring loading enhances trigger sensitivity
- SRI Pro Lite is supplied as standard with a quality screw-top gravity feed cup with 125mls capacity
- Optional inexpensive semi-disposable cups are available.

Specification	
Air Supply Connection	1/4" Universal
Maximum Static Air Inlet Pressure	P1 = 12 bar (175 psi)
Service Temperature	0 to 40°C (32 to 104°F)
Gun Weight – Gun Only	395g (455g with cup)

Size	Fluid Tip Part Number	Needle part number
0.6mm	SRIPRO-210-06M-K	SRIPRO-310-06M-K
0.8mm	SRIPRO-200-08-K	SRIPRO-300-08-10-K
1.0mm	SRIPRO-200-10-K	SRIPRO-300-08-10-K
1.2mm	SRIPRO-200-12-K	SRIPRO-300-12-14-K
1.4mm	SRIPRO-200-14-K	SRIPRO-300-12-14-K

N.B All SRI Pro Fluid tips and needles are high quality stainless steel.

Air Cap number & Type		Part Number	Air Consumption	Recommended Fluid Tip/ Air Cap Combinations				
				0.6 mm	0.8 mm	1 mm	1.2 mm	1.4 mm
TE5	Trans-Tech	SRIPRO-102-TE5-K	100 L/min (3.5 cfm)		■	■	■	■
HV5	HVLP	SRIPRO-102-HV5-K	135 L/min (4.8 cfm)			■	■	■
RS1	Round Spray	SRIPRO-102-TRS1-K	55 L/min (1.9 cfm)			■	■	■
MC1	SRI Pro Micro Trans-Tech	SRIPRO-102-MC1-K	50 L/min (1.8 cfm)	■				

BINKS TROPHY SERIES TOUCH-UP SPRAY GUNS

The Binks Trophy Series Touch-Up Spray Gun is the most versatile small gun on the market. The HVLP and LVMP air caps are optimised to provide ultra sensitive fan pattern control to spray at patterns up to 6 inches wide (150 mm). With gravity, suction and pressure versions, this gun will spray all of your small parts. In addition to being small and lightweight, the ergonomic design sets a new standard for touch-up guns.

Typical Applications

Sprays most paints including:-

- Stain
- Epoxy
- Enamel
- Non-Stick Coatings
- Low Viscosity Adhesives

TOUCH-UP GUN SPECIFICATION	
Max Air/Fluid Pressure	100 psi / 6.9 bar
Gun Body Anodized	Aluminium
Fluid Path	Stainless Steel
Fluid Inlet (Pressure gun)	3/8" NPS / BSP(m)
Air Inlet Size	1/4" NPS / BSP(m)
Gun Weight (pressure)	372 grams
Gun Weight (gravity no cup)	340 grams
Wetted Parts (gun)	Stainless Steel & PTFE
Wetted Parts (gravity cup)	Aluminium and Plated Brass
Wetted Parts (suction cup)	Polyethylene and Plated Brass

TOUCH UP SPRAY GUNS		
Part Number	Needle Material	Type
HVLP		
1465-08HV-C1S-E	Stainless Steel	Pressure
1466-10HV-C1S-E	Stainless Steel	Gravity
LVMP (Trans-Tech)		
1465-10LV-B1S-E	Stainless Steel	Pressure
1465-12LV-B1S-E	Stainless Steel	Pressure
1466-10LV-B1S-E	Stainless Steel	Gravity
1466-12LV-B1S-E	Stainless Steel	Gravity

YELLOW INDICATES STANDARD SET-UP

Trophy Touch-up Gun

Trophy Air Cap Code	Spray Technology	SCFM	LPM	Fluid tip Size Range	Coating Types
B1	LVMP (Trans-Tech)	7.8 @ 30 psi	220 @ 2 bar	0.8 mm - 1.2 mm	Thin
C1	HVLP	6.5 @ 20 psi	181 @ 1.4 bar	0.8 mm - 1.2 mm	Thin

Gun Inlet Pressure is measured at the gun inlet fitting with the gun triggered.



81-384 - Touch-up suction cup assembly



54-4458 - Touch-up aluminium gravity cup assembly

JGA

PRESSURE SPRAY GUN FOR ENAMEL, CERAMIC AND GLAZE APPLICATIONS

DeVilbiss JGA Spray Gun "The Industry Standard"

JGA Conventional Spray Guns are built to withstand continuous production line duty, the gun body is produced from drop forged aluminium and is built for easy maintenance by the operator. DeVilbiss air caps,

fluid tips and needles are available in stainless, hardened and tungsten carbide steel and are precision engineered to produce finely atomised patterns with first class material distribution throughout the spray pattern.

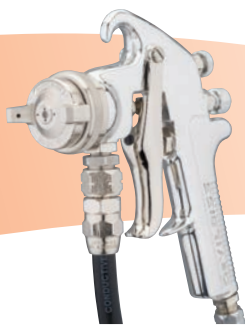

Air Cap Number and Type	Tip Size	Recommended Air Inlet Pressure	Air Flow @ 3.4 BAR / 50psi
62HD Conventional spray	2.8 mm	3.5 BAR / 50 psi	502 l/min (18 scfm)
64HD Conventional spray	2.2 mm	3.5 BAR / 50 psi	488 l/min (17.5 scfm)
67HD Conventional spray	1.8 mm	3.5 BAR / 50 psi	539 l/min (19 scfm)
69HD Conventional spray	2.2 mm	3.5 BAR / 50 psi	572 l/min (20.5 scfm)



CSPRAY PRESSURE AND GRAVITY MANUAL SPRAY GUNS



The DeVilbiss spray gun range especially for the Yacht and Light Marine market.

- Designed in partnership with the market leading paint manufacturers
- New Critical Droplet atomisation Technology air caps provide enhanced performance and best finish right across the range of Marine paints.
- Cspray has Stainless Steel tips, needles and fluid passageways as standard

- Curved gun handle – enhances gun handling and greatly reduces operator fatigue
- Lightweight gun design with lighter trigger pull and improved air flow.

All Cspray guns are precision built by DeVilbiss using the best materials and component parts for a guaranteed, reliable, long and durable working life.

Part Number & Type	Air Consumption	Air Inlet Pressure	Typical Fluid Flow	Typical Fan Width
CDT Pressure Air Cap	540 l/min (19.1 scfm)	3.5 bar (50 psi)	200-500 cc/min	430 mm
CDTG Pressure Air Cap	345 l/min (12.3 scfm)	3 bar (45 psi)	200-300 cc/min	300 mm

Cspray Pressure Spray Gun Kit
Part No. ADV-PCDT-10 (1.0 mm tip & CDT air cap)
Part No. ADV-PCDT-12 (1.2 mm tip & CDT air cap)

Cspray Gravity Spray Gun Kit
Part No. ADV-GCDT-12 (1.2 mm tip & CDTG air cap)
Part No. ADV-GCDT-16 (1.6 mm tip & CDTG air cap)



FLG5 MANUAL SPRAY GUNS



FLG-5 is suitable for most routine spray jobs in the workshop and can also be used by DIY enthusiasts. This budget range of spray guns are available as spray gun kits in Suction and Gravity versions and there is also a Pressure gun option for the larger areas requiring fast coverage without the added down time of re-filling small cups.

- Low cost spray guns for use with a wide range of general industrial paints and materials
- FLG-5 employ DeVilbiss TRANS-TECH® atomisation for paint saving efficiency, superb finishes plus compliance with EPA legislation
- Ultra lightweight, strong, cast aluminium gun body
- Ergonomically shaped gun handle for balance, grip and comfort
- Precision engineered brass air cap and stainless steel fluid tips and needles for long service life

The low cost solution: Suction and Gravity guns are supplied in kits.

Air Cap No	Tip Size 1.4mm	Tip Size 1.8mm	Tip Size 2.0mm
No 5 Cap	G	G S	G
No 622 Cap	P		

P = Pressure G = Gravity S = Suction

Example of gun part numbering:
 FLG5-G5-14 = FLG5 = Gun
 G5 = Gravity/Air Cap
 14 = Fluid Tip.

DAGR MANUAL AIRBRUSH



DAGR sprays most light paints and finishes with excellent control and hairline detail. High paint-flow shading and gradual fades can be achieved. It has a crown design cap to allow fine line work and to protect the needle from accidental damage. As standard it is supplied with a removable 1/3 fl oz gravity cup and servicing spanner. For really small area work the artist can choose to use no cup at all by filling the reservoir in the airbrush barrel itself. The airbrush is well-balanced with a smooth, double-action trigger. The solvent proof, PTFE needle packing will not deteriorate with automotive paints. As with all DeVilbiss products, service parts are easily available.

A collector's storage tin is included with every DAGR airbrush. DAGR is available from the wide network of DeVilbiss' distributors.

- Hairline detail to high paint-flow shading and gradual fades
- Smooth double action trigger
- Pre-set handle for precise control of paint flow
- Light weight and balanced
- Choice of trigger buttons
- Removable 1/3 oz gravity cup with optional 1/4 oz and 1/2 oz



DGR-501G-13



Operating Pressure	1.3-3.5 bar (20-50 psi) Maximum
Inlet Pressure	12 bar (175 psi)
Fluid tip	0.35 mm
Cup capacity	9 mls (1/3 fl/oz)
Air hose connection	1/4" NPS (M)
Universal fluid threaded connector	3/8"

DEVILBISS AG-360 SERIES

1 2 3 4 5

THE UNIVERSAL ALL ENCOMPASSING AUTO SPRAY GUN LINE UP FROM DEVILBISS

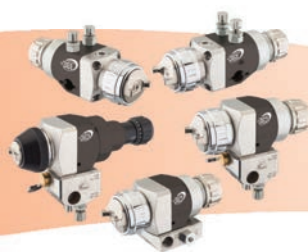

Professional spray equipment for universal superior performance.

Using the acknowledged market leading low Pressure Air Atomisation technology from DeVilbiss, the AG-360 series has been developed to provide a blend of finish quality, engineering robustness and superior Transfer Efficiency. The AG-360 Auto gun Series from DeVilbiss is available in various gun formats to provide an all-encompassing and universal automatic finishing solution for all applications. Designed to function in the tough working environment of the modern finishing industry, these guns give you maximum productivity with minimum downtime.

AG-361 variants are designed to be cost effective guns with maximum control and serviceability. Available in two models – the **AG-361** for general industrial finishing and the **AG-361E** for the ceramics industry.

The **AG-362** guns are more versatile designs – the **AG-362** for general industry and the **AG-362P** particularly developed for the cosmetics and glass industries.

The **AG-362** guns are available with two different design manifolds to allow you to choose the layout of air/fluid connection and method of gun attachment. The **AG-362L** Lever operated version for fastest removal and the **AG-362S** Screw attached version with multiple machine mounting options and smaller size.

- A comprehensive range of CONventional, HVLP and Trans Tech (High Efficiency) Air Caps provide a choice of Environmental compliance, Transfer Efficiency, Atomisation power and application requirements.
- Simple construction and easy maintenance for minimal down-time.
- Stainless Steel Fluid Passageways for Water based & Solvent based coating applications.
- Quick detachable mounting manifolds provide fast and easy maintenance.
- Compact size and weight for easy positioning and precise alignment.
- Multiple options and formats to evolve for all application requirements.
- Independent Fan, Atomising and Trigger Air – vital for Robotic and fully automatic machine applications.

DEVILBISS AG-361

NON-MANIFOLD GUN



1 2 4



AG-361 - The Market Leading automatic spray guns for General Applications.

AG-361 is purpose made to provide a long working life in tough working conditions. The gun uses the very latest advances in atomising technology to provide users with a cost effective air atomising spray gun with many unique, patented features and benefits.

- Low Pressure Air Atomising Spray gun for fine finishing and General applications.

- AG-361 series shares common Air Caps and fluid tips with the market leading DeVilbiss PRO Lite hand gun. This means the AG-361 range offer consistent application parameters between Automatic and Hand spray stations in the same facility
- Modular, easy to maintain gun construction
- High Grade Stainless Steel gun head and fluid passageways for use with all coating types
- Air Caps available in HVLP, Trans Tech/High Efficiency and CONventional Air Atomisation versions
- Total control of application parameters by means of independent Atomising and Spray Pattern air plus an 18 'click' per revolution fluid needle control knob.

Air Cap and Fluid Nozzle Options AG-361 Gun

Air Cap	Atomisation Type	0.85mm	1.0mm	1.2mm	1.4mm	1.6mm	1.8mm	2.0mm	2.2mm
C1	Conventional	S	S	S	S	S	S		
C2	Conventional	S	S	S	S	S	S		
C3	Conventional	S	S	S	S	S	S		

These Air Caps match with PROC-215-XX Fluid Nozzle where XX=orifice size

HV30	HVLP	S	SN	S	SN	S	SN	S	SN
TE10	Trans Tech (High Efficiency)	S	SN	S	SN	S	SN	S	SN
TE20	Trans Tech (High Efficiency)	S	SN	S	SN	S	SN	S	SN
TE30	Trans Tech (High Efficiency)	S	SN	S	SN	S	SN	S	SN
TE40	Trans Tech (High Efficiency)	S	SN	S	SN	S	SN	S	SN
TE40R	Trans Tech (High Efficiency)	S	SN	S	SN	S	SN	S	SN

These Air Caps match with PRO-205-XX Fluid Nozzle where XX=orifice size

S= High Quality Stainless Steel Tips & Needles available in this type & size

N= Nitride Hardened Tips & Needles also available in this type & size

DEVILBISS AG-361E CERAMIC AND ENAMEL INDUSTRY GUN



A specialised version of the AG-361 for the application of Ceramic Glaze and Waterbased Enamels. The AG-361E has an extended range of specialist Air Caps and Fluid Nozzles capable of handling the high fluid flows and abrasive nature of the coating and environment.

- Completely new dedicated air cap range for the superior application of coatings onto Sanitaryware, Tableware and all ceramicware
- Stainless Steel, Hardened Stainless, Nitride Hardened and Tungsten Carbide version Fluid Nozzles & Needles for abrasive coatings
- Special O ring needle packing designed for waterbased abrasive particle coatings.

Air Cap and Fluid Nozzle Options AG-361E Gun

Air Cap	Atomisation Type	1.4mm	1.6mm	1.8mm	2.0mm	2.2mm	2.8mm
C1	Conventional	S	S	S			
C2	Conventional	S	S	S			
C3	Conventional	S	S	S			

These Air Caps match with PROC-215-XX Fluid Nozzle where XX=orifice size

HV30	HVLP	SN	S	SN	S	SN	
TE10	Trans Tech (High Efficiency)	SN	S	SN	S	SN	
TE20	Trans Tech (High Efficiency)	SN	S	SN	S	SN	
TE30	Trans Tech (High Efficiency)	SN	S	SN	S	SN	
TE40	Trans Tech (High Efficiency)	SN	S	SN	S	SN	
TE40R	Trans Tech (High Efficiency)	SN	S	SN	S	SN	

These Air Caps match with PRO-205-XX Fluid Nozzle where XX=orifice size

C62	Conventional						SNC
C64	Conventional					SNC	
C67	Conventional	SN		SNC			

These Air Caps match with PRO-250-XX Fluid Nozzle where XX=orifice size

S= High Quality Stainless Steel Tips & Needles available in this type & size
 N= Nitride Hardened Tips & Needles also available in this type & size
 C= Tungsten Carbide Tips and Needles also available in this type & size

DEVILBISS AG-362 THE UNIVERSAL COATING GUN



Built to the same superior specification as the AG-361 automatic guns but with the addition of a quick detachable Manifold base. This allows the gun to be quickly and easily removed for maintenance, cleaning or change-over without disturbing the positional settings. On re-attaching the fluid and air can be turned back on and the gun is instantly in the right location ready for operation.

- Two manifold versions are available:
- A lever operated cam version allowing very fast removal and replacement of the gun during the production process
 - A low profile screw attached version which also has the pressure capability for mounting the A-363 Air Assisted Airless Automatic gun. Just swap gun, change pump and spray!

Air Cap and Fluid Nozzle Options AG-362 Spray Gun

Air Cap	Atomisation Type	0.85mm	1.0mm	1.2mm	1.4mm	1.6mm	1.8mm	2.0mm	2.2mm
C1	Conventional	S	S	S	S	S	S		
C2	Conventional	S	S	S	S	S	S		
C3	Conventional	S	S	S	S	S	S		

These Air Caps match with PROC-215-XX Fluid Nozzle where XX=orifice size

HV30	HVLP	S	SN	S	SN	S	SN	S	SN
TE10	Trans Tech (High Efficiency)	S	SN	S	SN	S	SN	S	SN
TE20	Trans Tech (High Efficiency)	S	SN	S	SN	S	SN	S	SN
TE30	Trans Tech (High Efficiency)	S	SN	S	SN	S	SN	S	SN
TE40	Trans Tech (High Efficiency)	S	SN	S	SN	S	SN	S	SN
TE40R	Trans Tech (High Efficiency)	S	SN	S	SN	S	SN	S	SN

These Air Caps match with PRO-205-XX Fluid Nozzle where XX=orifice size

S= High Grade Stainless Steel available in this type and size
 N= Nitride Hardened Tips & Needles available in this type & size

AUTOMATIC SPRAY GUNS

DEVILBISS AG-362P
PETITE HEAD REMOVABLE MANIFOLD GUN



A modified manifold mounted gun designed for the precision application of coatings onto cosmetics packaging and glassware. The gun utilises 'Petite' precision air caps and fluid nozzles specifically designed for this style of application. For extra-fine fluid control the gun is fitted with a Micrometer vernier needle control knob assembly that allows ultra-fine precision fluid setting.



1 2 4



Precision Micrometer needle adjustment can be fitted as standard on all AG-361 and AG-362 guns. It is also available as an accessory.

Air Cap and Fluid Nozzle Options

AG-362P Air Cap	Atomisation Type	H 0.5mm	G 0.7mm	FHV 1.0mm
90HV	HVLP	S	S	S
90	Conventional	S	S	

These Air Caps match with CV-30-X Fluid Nozzle where X=orifice size code letter
 S= High Grade stainless steel Tips and Needles available in this type & size

COBRA 3c
LOW PRESSURE AUTOMATIC SPRAY GUN



The DeVilbiss Cobra 3c automatic spray gun is the ideal solution for spraying camera, computer and mobile phone components and many other products.

- Fast maintenance and serviceability
- Quick easy cleaning of external parts and internal passageways

- Air cap indexing for consistent application repeatability (option)
- Fast on/off operation of fluid needle
- Independent fan, atomising and triggering air for total machine compatibility.

1 2 3 4

Air Cap and Fluid Tip options and Part Numbers:

Air Cap Type	Part No.	Technology	Air Cap Code
590	SP-100-590-ADV-K	Trans-Tech	COM 590
590 HV	SP-100-590HV-ADV-K	HVLP	590 HV

Product part number example
CBA3C-590HV-10N means:-

CBA3C = Cobra 3c Automatic Gun
 590HV = Air Cap type
 10 = 1.0mm fluid tip diameter
 N = Hardened fluid tip and needle

Fluid Nozzle Size mm	Hardened Fluid Nozzle	Hardened Fluid Needle	Number on Fluid Needle
0.7	SP-259N-07-K	SPA-353-07-K	3C 07
0.85	SP-259N-085-K	SPA-353-085-K	3C 085
1.0	SP-259N-10-K	SPA-353-10-K	3C 10

AGMD PRO
AUTOMATIC SPRAY GUN



The AGMD Pro gun can be configured for standard machine mount applications or upon adapters and hose bundles suitable for most common painting robots.

- DeVilbiss Compliant Atomisation Technology
- "Pro" High Performance front end technology with removable/replaceable baffle and air cap retaining threads

- New radial clamping device with quick release cam operation from either side of gun – compact and convenient
- Fast trigger cycle at lower air pressures
- Same "Tool Centre Point" as original AGMD model
- Certified air caps with indexing facility
- Plastic tip needle on St/St seat for increased life (option)
- Suitable for waterborne and solvent based coatings.

1 2 4

Part Number example:
AGMDPROU-XXXX-YYP

AGMDPRO = Gun
 U = Fluid Recirculation
 XXXX = Aircap
 YY = Tip and Needle
 P = Plastic Tipped Needle

Air cap type and air consumption	
TE30 High Efficiency Air Cap:	365 l/min (12.9 cfm) @ 2.0 bar (30 psi)
TE40 High Efficiency Air Cap:	350 l/min (12.4 cfm) @ 2.0 bar (30 psi)
TE50 High Efficiency Air Cap:	425 l/min (15.0 cfm) @ 2.0 bar (30 psi)

Fluid tip sizes 0.85, 1.0, 1.2, 1.4mm

AGMD Pro Robot and Machine Adaptors

Part Number	Description
AMGDPRO-402-K	Intermediate Plate
AMGDPRO-403-K	Machine Adaptor (M.A.)
AGMD-261-1	M.A. with dump valve
AGMD-261-AB-1	M.A. with 5 valves (2 colour, 2 dump, 1 solvent) dual purge
AGMD-9400-2K	Gun Adapter with 5 colour valves, 1 hardener, 1 solvent
AGMD-300-2K	2K adapter with 3 valves (1 colour, 1 hardener, 1 solvent)
AGMD-3278-R-2	Double Gun Adapter with dump valves
AGMD-3279-R-2	Robot Mounted Gun Adapter 90° with dump valve



SPRAY GUN EXTENSIONS FOR ADVANCE HD MANUAL AND COBRA 2 AUTOMATIC GUNS

1 4 5

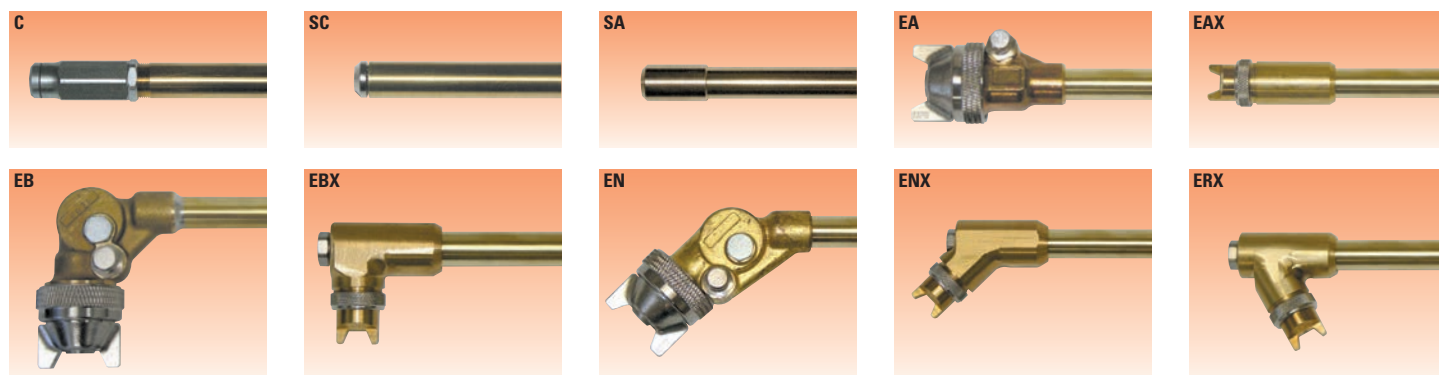

A wide range of DeVilbiss extensions are available for those difficult to reach applications.

The DeVilbiss extension range is manufactured from brass with stainless steel needles as standard, they are available for Advance HD manual and Cobra 2

automatic pressure spray guns. When ordering ensure the part number for the model is completed with the required length in inches. Other lengths and flexible extensions are available upon request.

To order a spray gun for the extension use the part number **ADV-000-00** or **CBA2-000-00**. Bare spray gun's exclude needle, air cap, fluid tip and retaining ring.

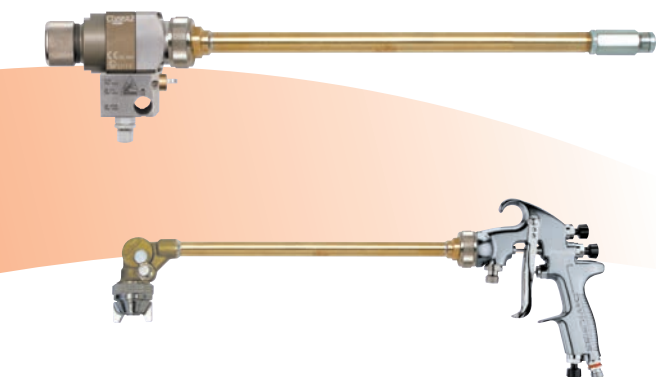

(spray guns not included with extensions)

Ref	Type	Code	Clearance
C	360° circular spray	EXTCB2-C-XX	3/4" (19 mm)
SC	360° circular spray	EXTCB2-SC-XX	3/8" (9.5 mm)
SA	forward round spray	EXTCB2SA-XX	7/16" (11 mm)
EA	forward fan spray	EXTCB2-EA-XX	1 3/4" (44 mm)
EAX	forward fan spray	EXTCB2-EAX-XX	7/8" (22 mm)
EB	90° fan spray	EXTCB2-EB-XX	3" (76 mm)
EBX	90° fan spray	EXTCB2-EBX-XX	1 7/8" (48 mm)
EN	45° fan spray	EXTCB2-EN-XX	2 5/8" (67 mm)
ENX	45° fan spray	EXTCB2-ENX-XX	1 3/4" (44 mm)
ERX	30° reverse fan spray	EXTCB2-ERX-XX	2" (51 mm)

Length measurement (approximate) is taken from the gun fluid inlet to the tip of the extension.

Extensions are complete with air cap, fluid tip, needle and air cap retaining ring. Extensions do not include the spray gun.

All fluid tips are stainless steel except type SC which are chrome plated brass and SA are plated steel.

Extensions are for use on pressure feed applications only.

Length options 6" (15cm), 9" (23cm), 12" (31cm), 15" (38cm), 18" (46cm), 24" (61cm), 30" (76cm), 36" (91cm), 48" (122cm), 60" (152cm), 72" (183cm), 84" (213cm)

AGN

AUTOMATIC SPRAY GUN FOR CERAMIC AND ENAMEL APPLICATIONS

1 5

- Needleless, diaphragm automatic spray gun
- Very Compact and lightweight
- High grade stainless steel and case hardened nitralloy steel Fluid Tips available
- For waterborne application.

AGN is a diaphragm operated automatic spray gun for use with ceramic glaze, vitreous enamels, liquid polishing compounds and similar materials. It is ideally designed for continuous applications such as ceramic tile manufacturing. It can also be used with solvent based coatings by fitting a PTFE protective diaphragm.



Air cap selection table

Part no	Tip code and diameter in mm										
	G 0.7	FX 1.1	FZ 1.2	FF 1.4	FW 1.6	E 1.8	EE 1.8	EX 1.8	DE 2.0	D 2.2	AC 2.8
AV-4239-30		■		■	■	■		■			
AV-4239-43				■	■	■		■			
AV-439-58		■	■	■	■	■			■		
MB-4039-62HD											■
MB-4039-64HD									■	■	
MB-4039-67HD							■				
MB-4039-78		■	■	■		■					
MB-4039-80				■	■	■		■			
AV-4239-186					■						
AV-4239-704	■	■	■	■		■					
AV-4239-705	■	■	■	■		■					
AV-4239-765	■	■	■	■		■					
AV-4239-777			■	■		■					
AV-4239-797			■	■		■					

Example of AGN spray gun part numbering:- AGN-502-YYZ-XX means...

- AGN-502 = Gun
- YY = Tip size
- Z = Tip material
 - H = stainless steel
 - N = nitrided steel
- XX = Air cap

Air supply atomising	1/4" universal
Diaphragm	6 mm push-in tube connector
Coating material supply	3/8" universal
Weight	560 g

AA4400M 2 4
by BINKS®

AA4400M
BINKS AIR ASSISTED AIRLESS HVLP MANUAL SPRAY GUN



AA4400M gun with AA10 HVLP air cap
(Flat tip not included)
Part no: 0909-4400-10000E



AA4400M gun with Twist Tip cleaner and
HVLP air cap (no tip)
Part no: 0909-4400-HT0000E

Binks Air Assisted Airless manual spray gun

The Binks AA4400M air assisted airless spray gun has been designed with the operator and environment in mind. This gun will handle the toughest spray jobs in all industrial markets whilst providing the best fit, feel and comfort operators demand. The spray gun is available with either HVLP or Trans-Tech® air caps operating at lower fluid and air pressures than competitors to achieve an exceptionally fine finish with superior paint savings and lower energy consumption.

Spray fan pattern is adjustable on the gun...

- Unique Trans-Tech or HVLP air caps provide a "Softer fine spray" for superior finish quality and higher transfer efficiency than competitors.

- Lightweight and Operator friendly design with lighter trigger pull tension
- Easy to remove "in-line" needle assembly for quick maintenance
- Adjustable needle packing and "balanced" air valve design
- Solid forged gun body for maximum durability and longer life
- Stainless steel fluid passages with tungsten carbide seats
- Gun handles Solvent and Waterborne coatings as standard
- Standard flat tip AND Twist tip cleaner available with a wide range of tips from .007" (0.18mm) to .035" (0.89mm).

Specification	
Air and fluid inlet thread	1/4" Universal (M)
Fluid passageways	Stainless steel
Gun weight	494 gm
Gun body	Forged aluminium
Max working pressure	303 bar (4400 psi)
Max air inlet pressure	6.8 bar (100psi)
Seat	Tungsten Carbide

Typical Applications

- Wooden Joinery and furniture
- Off road vehicles
- Aircraft
- Commercial vehicle chassis
- Skips and trailers.

Inline paint filter insert available in two sizes –
*60 mesh (kit of 5) pt. no. 54-5788-K5 and 100 mesh (kit of 5) pt. no. 54-5789-K5
*Fitted as standard with all guns.

AA4400M gun (only) part numbers	
0909-4400-10000E	AA4400M Air assisted airless gun with AA10 HVLP air cap, (Flat tip not included)
0909-4400-HF0000E	AA4400M Air assisted airless hand gun with HVLP air cap, (Flat tip not included)
0909-4400-LF0000E	AA4400M Air assisted airless hand gun with Trans-Tech air cap, (Flat tip not included)
0909-4400-HT0000E	AA4400M Air assisted airless hand gun with Twist Tip cleaner and HVLP air cap (no tip)
0909-4400-LT0000E	AA4400M Air assisted airless hand gun with Twist Tip cleaner and Trans-Tech air cap (no tip)

†Order tip separately.
The full range of premium tips, pre-orifice and twist tips for the AA4400M gun are detailed in the Product Euro Flyer and Service Bulletin.

Gun and Hose packages

- AA4400M-AA10-75 SF** gun with flat tip assembly and tip OR
- AA4400M-75T SF** gun with twist tip cleaner attachment and tip.

Gun and hose packages include: AA4400M Air Assisted Airless Spray Gun with air cap, tip and 7.5 metre Air/Fluid Hose for use with standard Binks pump outfits.



MX LITE Package includes:-

Binks MX4/32 Tripod Mounted Pump with gun air and pump fluid controls. Stainless Steel pick-up tube and filter. 7.5 metre Ultra light weight Air and Fluid Hoses. AA4400M* Spray Gun and Tip with gun mounted stainless edge type fluid filter (optional gravity hopper).

(*Tip size to be specified at time of order)

See page 38 details



The unique Binks AA10 HVLP (54-5890K) air cap atomises at lower air pressures to provide the highest transfer efficiency with best finish.



Airless 75 with External Stainless Steel Tube – Part Number 0811-7500-1



Airless 75 with Direct Connect Part Number 0811-7500-2 Part Number 0811-7500-3 (large passage version)

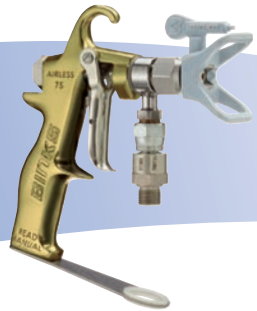

Airless 75M Direct Connect Part Number 0811-7500-4

AIRLESS A75

BINKS AIRLESS – THE PROFESSIONALS CHOICE

Binks Airless 75 Spray Guns for the toughest of spray jobs.

Operators will feel the difference when handling the lightweight Airless 75 gun thanks to the contoured handle design. The forged aluminium gun body is made to outlast the competition and will operate all the way up to 517 BAR (7500 psi) The unique needle design and extra wide stainless steel fluid passage-ways will accommodate everything from light stains to heavily bodied zinc rich paints. A wide range of high quality tungsten carbide twist tips are available to provide excellent atomisation and spray performance. Airless 75 Gun range includes a wide range of quality accessories to tackle all airless spray applications.

- Forged aluminium body for a long working life
- Two-finger trigger with Ergonomic handle to reduce operator fatigue
- Thick-walled stainless steel fluid tube for heavy and abrasive materials
- Exclusive needle design to keep spring out of the fluid path
- Adjustable needle packing for longer life
- A75M spray gun with larger 3/8" inlet for mastic and fire retardant coatings
- Optional Heat guard (available for tube version) for heated applications up to 79°C (175°F).

Airless 75 Specifications

Max Fluid Pressure:	7500 psi (571 BAR)
Gun Body:	Anodised Aluminium
Maximum Temperature:	175° F (79° C) (heat guard required)
Fluid Path:	Stainless Steel
Fluid Inlet:	1/4 NPS (3/8 NPS for 75M)
Gun Weight:	660 g

Airless 75 Spray Tip Selection Chart – PART NUMBER 9-XXX-75 (Tips rated for use at 7500 psi)

All of the following tips will have a grey tip handle.

	4" spray (102 mm) pattern	6" spray (152 mm) pattern	8" Spray (203 mm) pattern	10" spray (254 mm) pattern	12" spray (305 mm) pattern	14" spray (355 mm) pattern
.007 (0.18 mm) orifice		307				
.009 (0.23 mm) orifice		309	409	509		
.011 (0.28 mm) orifice	211	311	411	511	611	
.013 (0.33 mm) orifice	213	313	413	513	613	713
.015 (0.38 mm) orifice	215	315	415	515	615	715
.017 (0.43 mm) orifice	217	317	417	517	617	717
.019 (0.48 mm) orifice			419	519	619	
.021 (0.53 mm) orifice			421	521	621	
.023 (0.58 mm) orifice				523	623	
.025 (0.64 mm) orifice				525	625	
.027 (0.69 mm) orifice					627	
.031 (0.79 mm) orifice					631	
.035 (0.89 mm) orifice			435		635	

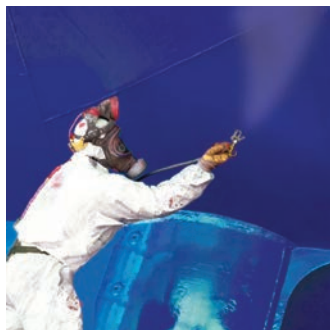

Part no: A75-1-75
A75 gun with ST ST feed tube (0811 7500-1) with 7.5 m hose (3/8" hose bore) and twist tip



Part no: A75-2-75
A75 Direct Connect gun (0811 7500-2) with 7.5 m hose (3/8" hose bore) and twist tip



Part no: A75-3M-75
A75M Direct Connect (Heavy Materials) gun (0811 7500-3) with 7.5 m hose (3/8" hose bore) and twist tip

BINKS EXTRUSION GUN

EXTRUSION GUN - 101503

The L6114 Extrusion Gun has been developed to meet the need for a light weight palm grip gun to extrude materials at fluid pressures of up to 340 Bar (5000 PSI). It is designed to handle sealants, mastics, adhesives and putties for a

wide variety of under body and joint sealing applications. Flow rate can be adjusted by the control on the back of the gun.

Service Kit 250086



AG-363 AIR ASSISTED AIRLESS HVLP AUTOMATIC SPRAY GUN



The Binks AG-363 combines the best features of Air Assisted Airless atomisation and Binks engineering to provide a superior atomisation and finish quality coupled with the highest possible transfer efficiencies, resulting in significant paint savings while complying with the toughest EPA regulations.

The AG-363 is a highly advanced Air Assisted Airless automatic spray gun that can be rapidly detached from its low profile manifold block using a simple hexagon key, for fast and easy maintenance and serviceability. This unique feature from Binks dramatically reduces production downtime and increases profitability.

Binks AG-363 is ideally suited for multi-gun finishing machines where repeatable high quality gun performance and total application flexibility are vital to high production environments and efficient throughput.

- Unique single screw attachment to manifold allows quick and easy removal for maintenance and cleaning, reducing downtime.
- HVLP air cap technology produces excellent atomisation with superior transfer efficiency and finishes.
- Air cap has optional 15° indexing for fast and repeatable air cap and tip positioning.
- Manual adjust air controls for easy spray fan adjustment and width control.
- Stainless Steel gun head and fluid passageways for Water based and Solvent based coating compatibility.
- Tungsten Carbide needle and seat for long working life and enhanced abrasion resistance.
- Choice of paint recirculation through gun head or manifold.

To order AG-363 Standard Tips insert the numbers from the chart into this part number: 114-XXXX

Tip Size	Fan Width (inch/mm) Maximum								
	2"/50mm	4"/100mm	6"/150mm	8"/200mm	10"/250mm	12"/300mm	14"/350mm	16"/400mm	18"/450mm
0.007/0.18		00704	00706	00708					
0.009/0.23	00902		00906	00908	00910	00912			
0.011/0.28		01104	01106	01108	01110	01112	01114		
0.013/0.33		01304	01306	01308	01310	01312	01314	01316	
0.015/0.38			01506	01508	01510	01512	01514	01516	01518
0.017/0.43			01706	01708	01710	01712	01714	01716	01718
0.019/0.48			01906	01908	01910	01912	01914	01916	01918
0.021/0.53					02110	02112	02114	02116	02118
0.024/0.61					02410	02412	02414	02416	02418
0.027/0.69					02710	02712	02714	02716	02718

Fine finish tips are also available for AG-363 (see service bulletin).

Gun Specifications	
Max Air Input Pressure	10 bar/145 psi
Max Fluid Input Pressure	275 bar/4000 psi
Trigger Air Pressure	4 to 10 bar/60 to 145 psi
Max Ambient Operating Temperature	85°C/185°F
Gun Head and Fluid Passageways	Stainless Steel
Gun Body Material	Anodized Aluminium
Manifold Material	Stainless Steel
Air Cap Material	Anodized Aluminium
Fluid Needle and Seat Material	Stainless Steel, Tungsten Carbide
Seals and O rings	HDPE, FEPM

460 BINKS AUTOMATIC SPRAY GUN

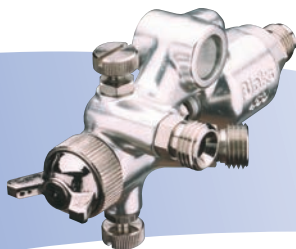

Air and fluid inlet 1/4" BSP Fluid passages aluminium

- Aluminium alloy body with plated brass air nozzle
- Stainless steel needle valve and springs
- Gun operation and spray atomisation is controlled from a single air supply
- Control valves for atomisation fan and air flow
- No lag, instant piston controlled "on and off"
- Good range of nozzles for virtually any liquid coatings

The Binks 460 Automatic Spray Gun is a small precision gun designed with accuracy in mind, for ease of fitting to existing automatic and semi-automatic machine. Its small scale dimensions enable the gun to be installed neatly and at close quarters, where the standard range of automatics cannot be accommodated.

Air cap selection table (Conventional)

Part no. and code	Tip diameter in mm			
	0.5	0.75	1.0	1.5
200831 J92S			■	
200833 J92P	■	■	■	
200838 K92P		■		■

BINKS MODEL 550 SPRAY GUN AIRLESS AUTOMATIC SPRAY GUN



Part no: 6700-0000-5. Tip not included

For spraying protective coatings such as lacquers, enamels, water based emulsions, mould release agents and sound deadeners. Spray gun equipped with tip guard, stainless steel fluid passages and forged aluminium spray gun body. Actuating air pressure is 40-60 psi. The material body may be

Air Inlet	1/4" NPS (m)
Fluid Inlet	1/4" NPS (m)
Weight	680 gm

installed in any of four positions to facilitate fluid hose connection. Spray tip not included, order separately. Mounting hole is 1/2" diameter, furnished with set screw. (Maximum operating pressure is 3000 psi).



Electrostatic Spray Guns and Equipment...

Ransburg.

Ransburg is the acknowledged global leader in the design, manufacture and marketing of manual and automatic electrostatic finishing products, providing spray finishing solutions to the key industrial and automobile manufacturing markets. Ransburg continues to refine the most efficient electrostatic spray painting technology, delivering a "Class A" finish to each and every customer's product, whilst reducing VOC emissions by providing excellent transfer efficiency and atomisation.

Binks, DeVilbiss and Ransburg are part of a global finishing group, focused on spraying and enhancing the sprayed finish of painted and coated surfaces.

Electrostatic Spraying (Manual Guns)

The Electrostatic technique can be applied to Air Spray, HVLP/ Compliant and Air Assisted Airless atomisation spray systems. Ransburg Electrostatic spray guns introduce a high voltage charge into the spray pattern which in turn adds the electrostatic charge into the atomised paint particles. The work-piece is earthed and the attraction between the atomised particles and the work-piece is strong enough to attract the paint/material onto the component with excellent "wrap" characteristics around the back of the work-piece. Providing very high deposition rates with high transfer efficiency, resulting in greatly reduced paint usage compared to conventional methods in full compliance with worldwide VOC regulations.



Innovation and Technical Excellence

Research and Development

Huge resources are dedicated to research and development. Ransburg work closely with the leading paint companies and specialists in surface coatings to ensure our equipment consistently provides the standard of finish our customers demand.

Technology Led Innovation

Ransflex cordless spray gun – Ransburg have reinvented the electrostatic spray gun with the introduction of the Ransflex manual spray gun by creating an applicator that operates by compressed air alone utilises an air driven alternator coupled to a high voltage cascade assembly that is used to generate the electrostatic charge internally, eliminating the need for an external power supply and cable.

This section depicts the all encompassing Ransburg range of manual and automatic electrostatic equipment and accessories for use on most applications.

Applications

- Aircraft and Aerospace
- Automotive
- Commercial and off road vehicles including fork lift trucks
- Intricate metal components and wire frames
- Agricultural machines and machinery
- Trailer/Chassis
- Railway engines and carriages including rolling stock
- Trade Coaters
- General metal finishing, plus many others

Compatible Material/Coating Types

- Solvent and Water Based Paints and Materials
- Compliant/High Solids Coatings
- Twin Pack Materials (2K)
- Metallic Paint
- Lacquers
- Acrylic Paints and Primers
- Enamel Paints
- 2K Polyurethanes, plus many others.



Greater Paint Savings with Improved Operator Comfort

With 20% fewer parts than previous models, RansFlex is easier to maintain and the patented turbine utilises a three-phase motor to reduce vibration and provide electrostatic power at lower input air pressures. RansFlex features quick voltage on/off controls on the gun with quick detach air hose connector at the handle to further reduce weight. Indexing air caps with unique colour coded fluid tips for easy identification, make RansFlex the perfect Electrostatic solution for all finishing applications.

Cordless portability and convenience - no generators or controllers:-

- Superior atomisation and transfer efficiency
- Lighter weight with superior ergonomic balance
- Quick and easy to set up "straight from the box"
- Lower running costs and maintenance
- For most solvent based paints and materials.

Ransflex Typical Markets and Applications include...

The Aerospace Industry, General Metal Spraying, Commercial and Off-Road Vehicles, plus many others...

Performance, balance, operator comfort, transfer efficiency and ease of maintenance...

45kV and 65kV operate like 65kV and 85kV!

That's RansFlex meeting the finishing needs of today and tomorrow.



RansFlex 45kV

RANSFLEX 45KV
LOW PRESSURE AIR SPRAY

Best in class atomisation in a compact, lightweight applicator, the all new RansFlex spray gun provides new features and benefits that surpass all other electrostatic applicators.

RansFlex is a low pressure air atomising electrostatic spray gun powered by an inbuilt turbine. Designed with the operator in mind, the handle incorporates many fit and feel improvements with better balanced weight to reduce operator fatigue. DeVilbiss World renowned air cap atomisation technology is coupled

with Ransburg electrostatic power to provide superior atomisation, transfer efficiency and performance, all backed by a 5-year limited warranty.

- Ergonomic fit, feel, balance and controls
- Redesigned sleek and smooth exterior
- Triple Turbine Protection
- Ergonomic handle profile and comfortable trigger
- Meets ATEX-CE/FM/CSA.

Specifications – Two Solvent Paint Models Available

45kV RansFlex RX	
Weight without hoses	599g (21.3 oz.)
Height	190.5 mm (7.5")
Width Max	41.2 mm (1 5/8")
Length	254.0 mm (10")
Operating Voltage	45 kV
Max Current	140 mA
Min Inlet Pressure	2.8 bar (40 psig) (dynamic at handle inlet)
Paint Conductivity	0.1 MΩ to infinity
Fluid Flow Capacity	1,000 ml/min.
Air consumption with voltage	438 lpm (15.4 scfm) (at handle inlet)
Material/Paint	Solvent based

65kV RansFlex RX	
Weight without hoses	620g (22.0 oz.)
Height	190.5 mm (7.5")
Width Max	41.2 mm (1 5/8")
Length	273 mm (10 3/4")
Operating Voltage	65 kV
Max Current	120 mA
Min Inlet Pressure	2.8 bar (40 psig) (dynamic at handle inlet)
Paint Conductivity	0.1 MΩ to infinity
Fluid Flow Capacity	1,000 ml/min.
Air consumption with voltage	438 lpm (15.4 scfm) (at handle inlet)
Material/Paint	Solvent based



RANSBURG 5-YEAR WARRANTY

Ransburg® warrants to the original end-use purchaser that the Ransburg branded products "Ransflex" shall not fail under normal use and service due to a defect in material or workmanship within five (5) years from the date of shipment from Ransburg. Does not include normal wear and tear parts.

MANUAL ELECTROSTATIC SPRAY GUNS

RANSFLEX 65KV
LOW PRESSURE AIR SPRAY

4



RansFlex 65kV

Best in class atomisation in a compact, lightweight applicator, the all new RansFlex spray gun provides new features and benefits that surpass all other electrostatic applicators.

RansFlex is a low pressure air atomising electrostatic spray gun powered by an inbuilt turbine. Designed with the operator in mind, the handle incorporates many fit and feel improvements with better balanced weight to reduce operator fatigue. DeVilbiss World renowned air cap atomisation technology is coupled

with Ransburg electrostatic power to provide superior atomisation, transfer efficiency and performance, all backed by a 5-year limited warranty.

- Ergonomic fit, feel, balance and controls
- Redesigned sleek and smooth exterior
- Triple Turbine Protection
- Ergonomic handle profile and comfortable trigger
- Meets ATEX-CE/FM/CSA.

45kV and 65kV models are available.

Part Number Ordering Example for a 45kV model:

When ordering use 80345-A,B,C,D,E,F. 6 digits must follow to provide the correct part number.

80345-ABCDEF

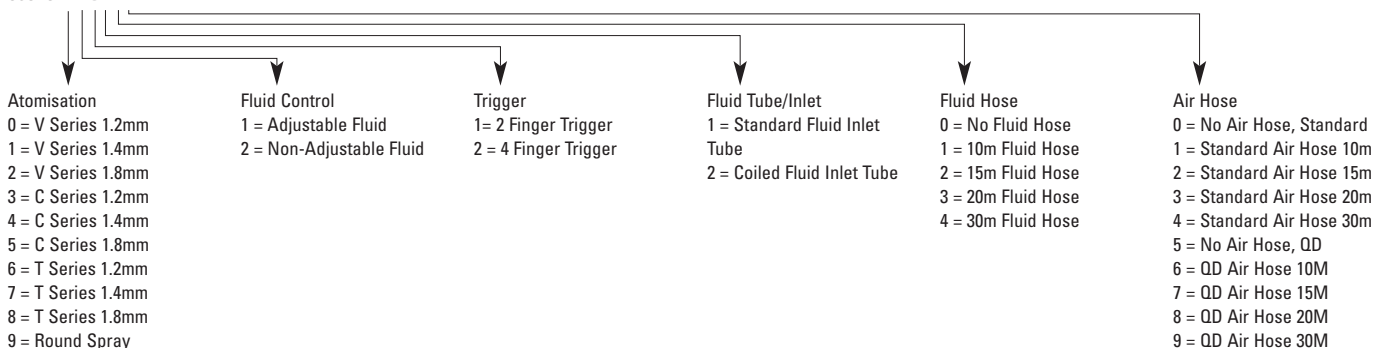

Solo AA90 for high pressure atomisation applications.

Solo AA90 has a tip range from 0.009" (0.23mm) to 0.021" (0.53mm) with a choice of fan and round spray caps.

SOLO AA90 85KV
AIR ASSISTED AIRLESS

4

The Vector Solo AA90 combines air-assisted airless technology with proven atomisation in a portable, cordless model. With superior Ransburg electrostatics, this gun delivers advanced spray pattern characteristics, unmatched pattern adjustability and extraordinary transfer efficiency. Enhanced spray pattern characteristics deliver a precise and consistent application. The Vector Solo AAA's pattern adjustability allows the decrease of overall pattern size, improving accuracy and creating a uniform finish. Ransburg's best in-class atomisation also reduces overspray and paint waste for cost savings. Vector Solo's cordless design increases flexibility. Operators have a greater

range of movement to achieve consistent applications. The superior ergonomic balance improves user comfort and lessens fatigue for an increase in productivity.

Vector Solo AA's efficiency, convenience and versatility helps to lower your bottom line.

- **Balanced Electrode Design...** Provides the best transfer efficiency in the industry
- **Easily Maintained...** Modular design makes it easy to repair and replace components, (if needed)
- **Single Turn Fan Pattern Adjustment...** Reduces overall pattern size by 30%.

Specifications

Length	269mm / 10.6 in
Weight	973 g / 34.0 oz
Hose Lengths	10m, 15m, 20m, 30m
Fluid Flow Capability	1500 ml/min
Operating Pressure	
Fluid	0-206.8 bar / 0-3000 psi tip / material dependant
Air	0-6.9 bar / 0-100 psi
Consumption	470 SLPM / 16.6 SCFM @ 2.8 bar / 40 psi @ the handle inlet

Fluid Tip Selection Table

Pattern width inches (mm)	5(127)	8(203)	10(254)	13(330)	15(381)	17(432)
Bore Ø inches (mm)	Part no. 79691-...					
0.009 (.23)	0509	—	1009	—	—	—
0.011 (.28)	0511	0811	1011	1311	1511	—
0.013 (.33)	0513	0813	1013	1313	1513	—
0.015 (.38)	—	—	1015	1315	1515	1715
0.018 (.46)	—	—	1018	1318	—	—
0.021 (.53)	—	—	1021	—	1521	—

Electrical	
Operating Voltage	85kV DC (-) Max
Current Output	130 Microamps Max
Paint Resistance	.1M Ohm to Infinity

1 Tips/needles = Stainless Steel as standard 2 Stainless Steel fluid passageways
3 Optional = Tungsten Carbide and hardened tips/needles 4 Substrate = Wood, metal, plastic and others 5 Substrate = Ceramic and glaze

Manual Electrostatic Spray Guns for all Low and High Pressure Applications

Reduced weight and trigger pull with improved ergonomics.

VECTOR R90 CASCADE SOLVENT / WATERBORNE

LOW PRESSURE AIR SPRAY

Vector R70 & R90 Cascade guns

How exactly did Ransburg make the Vector Cascade Gun even better? By listening to our customers; We reduced the gun's weight, increased durability, lightened the trigger pull, improved the finish and transfer efficiency and simplified the controls. Ransburg reduced the gun weight by a massive 24% which greatly improves operator comfort and reduces fatigue, which adds up to improved productivity and job satisfaction. Vector guns options are available for both waterborne or solvent based paints.

- Conventional air spray
- Reduced overspray - High transfer efficiency
- Modular design - Easy maintenance
- Highly manoeuvrable - Light trigger pull
- Operator friendly - Controls on the gun
- Rugged construction for durability 85kV sprays most types of fluid
- Gun has triple voltage set point adjustment on the gun and voltage on/off on the gun



Waterborne version

Some Typical Applications

Model	Spray Technology	Domestic	Metal & Appliances	Wood Furniture	Tier 1 Car	Aerospace parts	High Voltage	Max kV Generator
R90*	Air Atomising - Low Pressure	■	■	■	■	■	Internal - Cascade	85
R70	Air Atomising - Low Pressure	■	■	■	■	■	Internal - Cascade	65
R90*	Air Atomising - Low Pressure	■	■	■	■	■	External - Classic	85
R70	Air Atomising - Low Pressure	■	■	■	■	■	External - Classic	65

* Waterborne versions are also available.



New 9060 power supply

VECTOR R70 CASCADE

LOW PRESSURE AIR SPRAY

Vector R70 Cascade is a smaller, lighter version of the R90



Fluid Tips and Air Caps for all Vector Series low pressure guns

Fluid Tips	Air Caps
0.7 mm (0.028")	65 Conventional 98 Conventional 122 Trans-Tech
1.0 mm (0.042")	
1.2 mm (0.047")	
1.4 mm (0.055")	
1.8 mm (0.070")	
Round Spray	Round Spray

For detailed tip/cap range and application data see the appropriate Ransburg Vector service bulletin.

VECTOR R90 CLASSIC SOLVENT / WATERBORNE

LOW PRESSURE AIR SPRAY

Vector R70 & R90 Classic Guns

Ransburg Vector Classic Guns utilise "state-of-the-art" materials in the handle, barrel, trigger and air cap. Front to back and top to bottom, Vector Guns are tougher and more streamlined with better weight distribution for improved balance and ergonomics.

The Gun's controllers provide the operator with triple-set point voltage controls, plus power on and off, right on the gun. The microprocessor based control allows for data collection which can record the amount of paint used and parts painted.



Waterborne version

Vector Series data

Technical data	VECTOR R 70 solvent		VECTOR R 90 solvent		VECTOR R90 waterborne	
	Classic ¹	Cascade ²	Classic ¹	Cascade ²	Classic ¹	Cascade ²
Spray gun model	79504	79501	79503	79500	79520	79523
Order number	79504	79501	79503	79500	79520	79523
Atomisation	Conventional	Conventional	Conventional	Conventional	Conventional	Conventional
Length	24 cm	24 cm	27 cm	27 cm	27 cm	27 cm
Weight	555 g	650 g	620 g	735 g	620 g	735 g
Operating pressure air/fluid	7 bar (100 psi)	7 bar (100 psi)	7 bar (100 psi)	7 bar (100 psi)	7 bar (100 psi)	7 bar (100 psi)
Tip voltage	65 kV	65 kV	85 kV	85 kV	85 kV	85 kV
Max current	140 µA	90 µA	140 µA	100 µA	140 µA	100 µA
Max fluid temperature	65°C	65°C	65°C	65°C	65°C	65°C
Max fluid delivery	1,000 ml/min	1,000 ml/min	1,000 ml/min	1,000 ml/min	1,000 ml/min	1,000 ml/min

High voltage supply ¹external / ²internal

MANUAL ELECTROSTATIC SPRAY GUNS

VECTOR R70 CLASSIC

LOW PRESSURE AIR SPRAY

The R70 is a very light and compact spray gun which can be used in 'very tight' application areas. Wrap around as well as transfer efficiency are excellent which results in significant paint savings.



4

Fluid Tips and Air Caps for all Vector Series low pressure guns

Fluid Tips	Air Caps
0.7 mm (0.028")	
1.0 mm (0.042")	65 Conventional
1.2 mm (0.047")	98 Conventional
1.4 mm (0.055")	122 Trans-Tech
1.8 mm (0.070")	
Round Spray	Round Spray

For detailed tip/cap range and application data see the appropriate Ransburg Vector service bulletin.

VECTOR AA90

AIR ASSISTED AIRLESS

Vector AA90 is a rugged, yet lightweight Spray Gun designed with the painter in mind.

The Gun combines superior air-assisted airless atomisation technology with powerful electrostatic features, all in one gun. This integration results in a comfortable, lightweight gun with superior spray pattern characteristics, unmatched 'on gun' fan pattern adjustability with extraordinary high transfer efficiencies. Vector AA90 is available with an extensive selection of air cap and fluid tip combinations to ensure optimum performance is achieved with the coating materials you are using today and in the future.

and able to spray solvent or waterborne coatings. You select the system most suited to your application.

- Classic - The perfect combination of lightweight and simplicity
- Cascade - Designed for those applications where "on the gun" control of electrostatic power output is desired
- "Triple set point" voltage control "on the Cascade gun"
- Spray fan adjustment "on the gun"
- Ultra Lightweight gun with reduced trigger pull tension means reduced operator fatigue
- Solvent and waterborne paint compatibility
- FM and ATEX/CE approved.

Electrostatic power with flexibility

The gun is available in classic or cascade technology



Vector AA90



New 9060 power supply

Vector AA90 Technical Specification

Spray gun model	Classic	Cascade
Fluid pressure (max)	190 bar (2800 psi)	190 bar (2800 psi)
Atomisation	Air Assisted Airless	Air Assisted Airless
Length	29.2 cm	29.2 cm
Weight	708 g	793 g
Atomising air pressure (max)	6.8 bar (100 psi)	6.8 bar (100 psi)
Tip voltage	85 kV maximum	85 kV maximum
Max current	90 µA	90 µA
Max fluid temperature	65° C	65° C
Max fluid delivery	1,000 ml/min	1,000 ml/min

Tip Range: AA90

0.009" (.23 mm)
0.011" (.28 mm)
0.013" (.33 mm)
0.015" (.38 mm)
0.018" (.46 mm)
0.021" (.53 mm)

Ordering example:

79580-ABCDE

Gun Type

- 0 = Cascade
- 1 = Classic

Cable Length

- 0 = no cable
- 1 = 10 m (33 ft)
- 2 = 15 m (49 ft)
- 3 = 20 m (60 ft)
- 4 = 25 m (83 ft)
- 5 = 30 m (99 ft)

Trigger Style

- 2 = Two-Finger Trigger
- 4 = Four-Finger Trigger

Control Unit

- 0 = No Control Unit
- 1 = With Control Unit 110/120 VAC
- 2 = With Control Unit 220/240 VAC

Fluid Hose

- 0 = No Fluid Hose
- 1 = 11 m (33 ft)
- 2 = 15 m (49 ft)
- 3 = 23 m (75 ft)
- 4 = 30 m (99 ft)

Fluid Tip

- 0 = 85 kV Barrel Assembly, Cascade AA90, 0811 Carbide Tip without preorifice
- 1 = 85 kV Barrel Assembly, Cascade AA90, 0813 Carbide Tip without preorifice
- 2 = 85 kV Barrel Assembly, Cascade AA90, 1011 Carbide Tip without preorifice
- 3 = 85 kV Barrel Assembly, Cascade AA90, 1015 Carbide Tip without preorifice

Improved electronic control

The Vector control unit offers the operator 'triple set point' voltage control, plus power on and off, right on the cascade gun. This microprocessor based control allows for data to be collected. This data can then be used to correlate the amount of paint used and parts painted. The illuminated LED display on the control unit is visible at distances of up to 15 metres. External controls can be connected via the integrated connection terminals. Optional multi-position mounting brackets are available.

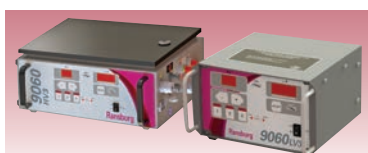

Models

- **9060 HV2:** used with the No. 2 Manual Gun
- **9060 HV3:** used with the Ransburg Classic style Manual Guns; Vector R70, Vector R90 (water or solvent)
- **9060 LV3:** Cascade style power supply used with Vector R70, Vector R90 (water or solvent) and Vector AA (air-assisted airless) manual guns.



NO 2 HAND GUN PURE ELECTROSTATIC ROTARY ATOMISATION

- "Pure" electrostatic atomisation - highest transfer efficiency
- Tried and tested technology
- Almost no overspray
- 90kV sprays most types of paints and fluids
- "Mobile" outfits available
- 3 bell sizes for all industrial applications
- Air turbine bell rotation.

Length	500 mm
Weight	1250 g

Operating pressure:	
Tip voltage	90 kV (max)
Current	120 µA (max)

Atomiser Bell sizes and Fluid delivery:	
70mm	(2¾") bell = 90 ml/min
100mm	(4") bell = 120 ml/min
180mm	(6") bell = 180 ml/min



9060 HV2

The Ransburg No. 2 gun is the only choice for on-site finishing and the No. 2 electrostatic atomisation spray technology is exclusive to Ransburg. The No. 2 gun offers a superb wrap around and an incredible transfer efficiency of between 95% and 98%.

Recommended Application: On-site furniture refinishing and wrought iron.



4



ESTAQUICK AUTOMATIC LOW PRESSURE AIR SPRAY

- Gun fits Automatic/Traversing machines
- High output paint flow capability (up to 1000cc/minute)
- Single OR twin pack (2K) material compatibility
Independent control of Atomising air, Fan air and Operating air
- Guaranteed spray repeatability - Estaquick Air Caps are accurately located onto the Gun Head to provide consistent spray repeatability
- Quick disconnect fluid tip (¼ turn bayonet type).

The Estaquick is a quick disconnect electrostatic air atomising spray gun. The spray head is manufactured in Peek material to make it robust and compatible for most

paint materials. The gun disconnects for service in less than 5 seconds thanks to an easy 90° turn mounting bracket.

Specification

Length	125 mm
Weight	245 g
Operating pressure air	7 bar
Operating pressure fluid	7 bar (max)
Tip voltage	100 kV (max)
Current	200 µA (max)
Fluid delivery	1.000 ml/min (max)
High voltage supply	Classic

4



EVOLVER 560 LOW PRESSURE AIR SPRAY

The Evolver is a robot atomiser that features a quick disconnect spray head to change from one head to another in less than one minute with only one tool, allowing for upkeep and repair offline without removal of the entire

applicator, and thus minimizing downtime. It is available in 60 or 90° single or dual head modules, HVLP or conventional air and with adapters for all types of robots.

Specifications

Atomising Air (per spray head)	7 BAR (100 psig) max
Fan Air (per spray head)	7 BAR (100 psig) max
Trigger Air	4.8 to 7BAR (70-100 psig) max
Fluid Without Regulator Option	14 BAR (200 psig)
Fluid With Regulator Option	7 BAR (100 psig) max
Regulator Pilot	4.8 to 7BAR (70-100 psig) max
Dump Pilot	4.8 to 7BAR (70-100 psig) max
Power Supply	MicroPak 2e



4

AEROBELL 168

HIGH QUALITY ATOMISATION IN A COMPACT ROBUST UNIT



The Aerobell 168 builds upon the strengths of our highly respected Aerobell atomisers. This cutting edge applicator is aimed at general industrial and Automotive Tier 1 applications and breaks new ground in terms of efficiency, performance and adaptability, whilst maintaining our reputation for robust engineering.

- New bell cup design gives improved atomisation performance

- Dual feed fluid tube ensures less waist from the individual paint and flush feeds
- Hard-wearing titanium bell cups as standard
- Easily removable shape air collar
- Turbine assembly removable through front access making maintenance and repair faster.
- Improved mono-flex and duo-flex shape air combinations.

Specification

Weight	2.7kg (4.4kg with robot adaptor)
Fluid Delivery	500ml/min
Turbine Speed	60,000 rpm
Bell Cups	30mm & 65mm
Charge	Direct and Indirect
Power Supply	9060 HV1 or Voltage Master 2

ICE BELL

AN INNOVATIVE APPLICATOR FOR FAST DRYING WATERBORNE COATINGS



The Ransburg Ice Bell is specifically designed for the application of fast drying waterborne coatings. This unique product is the only applicator able to cope with the challenges presented by these advanced materials. This advanced technology still comes with the traditional Ransburg qualities of longevity, reliability and high performance.

- Specifically designed for air-drying waterborne paints
- High transfer efficiency – up to 90%
- Integrated air-cooler device
- Excellent spray-pattern control and coating penetration
- Hard-wearing titanium bell cups as standard
- Quick disconnect features for turbine replacement.

Specification

Weight	5.1 kg
Length (Approx)	400mm
Fluid Delivery	500ml/min
Turbine Speed	Up to 60,000 rpm
Pattern Size	200mm to 800mm
Power Supply	Voltage Master 2.

RMA 500 SERIES

THE CUTTING EDGE ROBOT MOUNTED APPLICATORS



RMA-560

RMA-570

The Ransburg RMA 500 series electrostatic rotary atomisers are our newest, cutting edge applicators for the Automotive OEM and Tier 1 production sectors. Independent tests show they beat all competitor applicators in transfer efficiency and paint usage.

Available in a number of configurations, their modular design can be arranged for solvent based direct charge or waterborne indirect charge applications. The RMA 500 series incorporate single and dual purge valve manifolds

with colour coded tubing bundles for easy change outs and operational efficiency.

- Integrated trigger, dump and bell wash valves minimizes colour change time, paint loss and solvent usage
- Modular design offers fast and easy maintenance
- Hard-wearing titanium bell cups as standard
- Serrated and non-serrated bell cup design provides smaller, more uniform atomisation.

Specification

Weight	8.4 kg Indirect 5.5 kg Direct
Length (Approx)	450 mm Indirect 337 mm Direct
Fluid Delivery	20 to 700 cc/min
Turbine Speed	Up to 100,000 rpm
Power Supply	MicroPak 2e

TURBODISC



- Handles a wide variety of coatings
- Produces excellent finish uniformity and quality
- Delivers highest transfer efficiency
- Reduces overspray, cleanup and waste disposal
- Reduces VOC emissions and booth exhaust requirements
- Saves labour, energy and materials
- Lowers maintenance requirements.

The Turbodisc rotary paint applicator delivers better atomisation, improved quality and higher transfer efficiency with any of the wide variety of coating materials used in today's production finishing operations. The Turbodisc applicator can be installed as the heart of a new automated system or easily retrofitted to older style, low speed disc systems.

Power Supply – Voltage Master 2.

9060 POWER SUPPLIES

4



Ransburg 9060 power supplies are our latest generation power platform. They are based on proven Ransburg voltage

generation technology and area available in both high and low voltage versions.

Specifications

Ransburg 9060 LV1 Power Supply	
Part Number	80143-xxx (Atex Approved) c/w HV & LV Cables & Remote Cascade
Size	165 mm x 378 mm x 307 mm
Weight	10.2 kg
Input Voltage	100 – 240 VAC
Output Voltage	20 – 90 kV DC (Adjustable in 1kV increments)
Output Current	1 A max RMS

Ransburg 9060 HV-1 Power Supply	
Part Number	80100-xxx
Size	165 mm x 378 mm x 307 mm
Weight	10.2 kg
Input Voltage	100 – 240 VAC
Output Voltage	20 – 90 kV DC (Adjustable in 1kV increments)
Output Current	1 A max RMS

MICROPAK 2E POWER SUPPLIES

4



The MicroPak 2e controller represents the very latest cutting edge technology for high voltage supply. It combines our proven high-voltage generation technology with microprocessor based control, diagnostic and

communication functions, providing constant feedback on applicator system performance. The MicroPak 2e is available as a compact stand-alone unit or as a single component to fit into a Euro-rack system.

Specifications

Part Number	A13338
Size	129 mm x 213 mm x 165 mm
Power Required	24v @ 0.5A DC (Controller) 24v @ 6A DC (Cascade)
Output Voltage	0 – 100 kV DC
Output Power	100kV, 125 µA (HP404 / RP404 Cascade) 100kV, 1000 µA (RP100 Cascade) 100kV, 240 µA (HP505 Cascade)

VOLTAGE MASTER 2

4



VoltageMaster 2 is compact 2 part power supply featuring full PLC remote control capability and is completely backwards compatible with a universal range of applicators. With its ability to produce up to 100kV DC continuous

operating voltage while delivering up to 1,500 microamps load current, this is the workhorse power system for your finishing operation.

Specifications

Part Number	78789-04 (Control Panel) LEPS5001 (Power Supply)
Size	508 mm x 406 mm x 203 mm (Control Panel) 710mm (H) x 530mm (Ø) (Power Supply)
Weight	20.4kg (Control Panel) 115.2kg (Power Supply)
AC Input	201-260VAC @ 2.5A (Control Panel) 0 – 120VAC @ 4A (Power Supply)
HV Output	0 – 100kV DC 1500µA

PULSETRACK 2

4

ADVANCED SPEED CONTROL AND ENVIRONMENTAL MONITORING SYSTEM FOR ROTARY ATOMISERS



The Ransburg PulseTrack 2 is a microprocessor-based system designed to continuously monitor and maintain the programmable speeds of up to six rotary atomisers

while also monitoring temperature and humidity for one or more zones.

- Single location monitoring of multiple systems

Specifications

Part Number	A11515
Size	508 mm x 406 mm x 203 mm
Power Input	90 – 132 VAC @ 3A 176 – 264 @ 1.5A
Supply Air	110psi max
Remote enable pressure switches	15psi min to activate – 150psi Max

ELECTROSTATIC 2K PLURAL COMPONENT PAINT MIXING MACHINES

RANSFLOW

4



The RansFlow is a dynamic fluid metering system which offers closed loop metering and flow control of multi-component materials (2 or 3k). Simple and easy to integrate, the RansFlow fits seamlessly into your application and boasts programmable flush and fill to make colour change faster and a 99 'paint recipe' memory facility.

- 2K dual change flow control
- Up to 3 channels

- Integrated colour change
- Modular design offers remote (inside spray booth) fluid section
- Touch Screen control panel
- Intrinsically safe remote (in-booth) operator control panel
- Programmable Flush/Fill cycles
- Interfaces with a wide variety of flow meter types (gear, piston, Coriolis)
- True three channel, 3k programmable operation.

Specifications

Main Control Console Dimensions (HxWxD)	610mm x 610mm x 229mm	
Operating	Temperature	0° to 38° C (32° to 100° F)
	Humidity	0% to 95%
Power Input	240 VAC @ 1 A, 120 VAC @ 4A	
LCD Display	165mm (6 1/2") full colour with touch screen	
Flow Capacity	10 cc/min to 4000 cc/min per channel (depending on material and flowmeter limitations)	
Viscosity Range	30cp to 500cp	
PID Loop Updates	50times/second/channel	
Job tables	99 job Pre-sets per gun	
Data Connection	USB Port	

DYNAFLOW

4



The Ransburg DynaFlow is a versatile, eight channel metering and mixing flow controller with colour change optimization. Interfacing with the command system the Ransburg DynaFlow monitors, processes and quickly routes flow control data. Offering robust flexibility and enhanced performance, it delivers fast concise and repeatable material flow control for up to eight channels, making it the most flexible 2k flow control unit on the market.

- 2K dual change flow control
- Modular channel configuration

- Up to 8 channels
- Integrated colour change
- Modular colour changer with Air/solvent purge
- Configurable operating parameters: up to 8 manual/automatic applicators with 100 'recipes' per applicator
- Automatic reverse flow detection and alarm
- Pot-life alarms to alert user maintenance or initiate automatic flush sequence
- Weepless MVR Valve reduces chance of critical leakage.

Specifications

Main Control Console Dimensions (HxWxD)	610mm x 610mm x 457mm	
Pneumatic Interface Panel (HxWxD)	501mm x 610mm x 457mm	
Operating	Temperature	0° to 50° C (32° to 130° F)
	Humidity	0% to 95%
Power Input	240 VAC @ 1 A, 120 VAC @ 4A	
LCD Display	381mm (15") display with touch screen	
Flow Capacity	10 cc/min to 4000 cc/min per channel (depending on material and flowmeter limitations)	
Viscosity Range	30cp to 500cp	
Job tables	99 job Pre-sets per gun	
Data Connection	USB Port	

MULTI FLOW

4

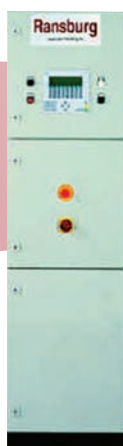

The Ransburg Multi Flow is an accurate and reliable unit for mixing and metering 2K materials. It is designed for fast response and can handle multiple flow rates and ratios depending on its user-defined customisable specification. The Ransburg Multi Flow utilises gear pump technology for hyper accurate metering and dispensing.

- Modular colour changer with air/solvent purge
- 2k Dual channel flow control
- Gear Pump technology

- Integrated colour change
- Customisable specification options
- Suitable for rotary atomizer, bells, disks and guns applications either electrostatic or non-electrostatic.
- Built in system diagnostics and intelligent fault message display.
- Optimization of purge/fill sequence via operator panel.
- Interfaces with PLC control for colour change and fill operations
- Suitable for both solvent and water based materials.

Specifications

Power Input	240 VAC 3 phase @ 15 A
Flow Capacity	10cc/min - 2000 cc/min
Max Air Pressure	3 bar
Max Fluid Pressure	2 bar
Fluid Inlet / Outlet	3/8"
Max Fluid Temp	35°

For Binks 2k Equipment see page 51

AQUAPACK SYSTEMS

4



Aquapack high pressure system



Aquapack low pressure system

Aquapack provides a safe operating system to apply most waterborne materials with the great atomisation and paint savings provided with Ransburg Spray Guns. Ransburg Aquapack's have been specially developed for the safe handling, storage, and supply of water based (high conductivity) paints with Ransburg Electrostatic Spray Guns. High and low pressure versions are available for use with Vector R90 (low pressure) and Vector AA90 (high pressure) spray guns. The entire paint supply and electrostatic control system is housed in a portable Polyethylene cabinet which provides safe handling of W.B. materials.

Unique safety feature:

The unit is automatically discharged to earth when the trigger on the gun is released and/or when the cabinet door is opened. These features also deactivate the Electrostatic High voltage during routine cleaning and colour changing.

- Handles most waterborne materials
- Low and high pressure outfits available
- Easy to operate and safe
- Completely assembled, tested and ready for use
- Mobile and easy to clean
- CE approved.

Note: Aquapack systems can also be used with Solo guns.

Technical Data	High Pressure/Air Assisted Airless	Air Atomising Low Pressure
Gun	Vector AA90 classic	Vector R90 Classic
Air Pressure	6.8 bar	6.8 bar
Fluid pressure	193 bar (max)	7 bar (max)
Tip voltage	50 kV (max)	85 kV (max)
Current	140 µA (max)	100 µA (max)
Fluid delivery	1.000 ml/min (max)	1.000 ml/min (max)
Pump ratio	31:1	1:1
Paint delivery pump	4,3 l/min (max)	9 l/min (max)
Material	ST ST	Aluminium, anodised
Cabinet height	1.670 mm	1.400 mm
Cabinet width	700 mm	700 mm
Cabinet depth	500 mm	500 mm
Weight	130 kg	100 kg

GEAR PUMPS

2 4



The Ransburg Gear Pump delivers a precise, stable and measured supply of coating material to the applicator. Compatible with a wide variety of solvent and waterborne coating materials, the Ransburg Gear Pump offers a broad range of options to meet your system's operational needs. The servo motor drives the gear pump's fluid block either via an isolator shaft or in a grounded, close-coupled configuration.

- High precision gear pump technology offers precise repeatable flows despite varying conditions and materials.
- Constant accurate flow, no pressure fluctuations
- Range of fluid block sizes available for multiple flow-rates.
- High quality materials make it resistant to corrosive materials

Specifications

Part Numbers:	Grounded dynamic	LPE-GD-1
	Grounded	LPE-GS
	Isolated	LPE-IS
Fluid Block Capacity Options		1.2cc/rev, 2.4cc/rev, 3cc/rev, 6cc/rev, 10cc/rev
Dosing Accuracy		± 2%*
Fluid Connections		¼" BSP (M)
Fluid Input Pressure		2 - 3 Bar
Output Pressure		15 Bar Max.
Operating Temperature		0 - 135°C Max.
Rotation Speed		From 10 RPM to 200 RPM (Depending on fluid section block specification)
Optimum Operational Speed		Between 30 RPM to 80 RPM
Standard Rotation Direction (viewed along shaft to block)		Clockwise (Anti-clockwise option available)
Sealing		Lip seals and liquid barrier
Construction Materials	Body	Stainless Steel (optional ADLC coated)
	Seals	Choice of materials depending on requirements
	Shaft	Coated Stainless Steel
	Gears	Tempered Stainless Steel (optional ADLC coated)



RECIPROCATORS

Ransburg new range of reciprocators offers efficiency, reliability and performance in a cost effective package. Available in a range of horizontal and vertical formats in a range of sizes, they offer both manual setting and PLC interface controls.

- Horizontal and Vertical Models
- Multiple Stroke Lengths
- Adjustable Cam Spray Control
- Moveable Base (on Vertical Model)
- Variable Speed (from 10-300 FPM)
- Continuous Running or Reversing Stroke
- Pneumatic Gun Trigger
- Multi-gun mountings

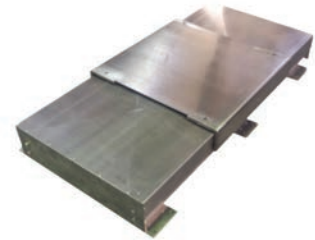

Specifications

Total Weight	420 kg (if stroke = 2500 mm)
Load of Sliding Mechanism	Up to 1.2m/s ²
Rated Power, drive motor	1.9 KW
Electrical connection	230 / 400 V 50Hz
Operational ambient temperature	0 - 40°C

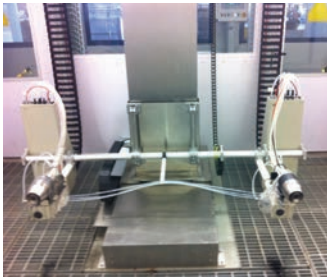



Pump and Fluid Handling Equipment...

BINKS®

Manufactures high and low pressure fluid handling pumps, low and high pressure manual and automatic spray guns, accessories, airless and air assisted airless spray painting outfits, regulators, pressure feed tanks, 2K plural component systems and paint circulating systems for the industrial finishing and automobile manufacturing markets.

A pioneer in spray finishing technology which includes the development and introduction of the world's first "stand alone" HVLP spray guns.

Binks, DeVilbiss and Ransburg are part of a global finishing group, focused on spraying and enhancing the sprayed finish of painted surfaces.

Binks – years of experience manufacturing the worlds best paint pumps

No other company has more experience and expertise in paint pump technologies used in reciprocating and diaphragm pumps. Binks pumps are not adapted from pumps made for other applications. The pump is at the heart of the paint delivery system, it has to work on demand whenever the spray gun is triggered to deliver smooth surge free paint for the application process.

Confirmed reliability

We work closely with the leading paint manufacturers to continually evaluate new designs and materials and research customer requirements to develop and improve our pump range. It is this special understanding and dedication to engineering excellence that makes Binks pumps the first choice for industrial markets worldwide.



BINKS MX, DX, MAPLE AND SMART SERIES 5-YEAR WARRANTY

Binks® warrants to the original end-use purchaser that the Binks branded products "MX", "DX", "Maple" and "Smart" shall not fail under normal use and service due to a defect in material or workmanship within five (5) years from the date of shipment from Binks. Does not include normal wear and tear parts.

Innovation and Technical Excellence

Plural Component 2K

Binks GEMS is the easy to operate 2K mixing solution that audits your paint resin and solvent usage while helping to reduce your solvent waste for up to 5 colours and 2 spray guns. GEMS delivers efficiency and convenience to meet real-world production schedules. Sturdy construction, quality components, ergonomic design, and powerful software make this the workhorse that will keep up with demanding projects.

Binks Magic-Flow is the easy and precise electronically controlled fluid handling plural component mixing system for all types of spray applications with guaranteed accuracy, reliable mixing and metering of two and optional three component materials. Designed as a "Plug and Spray" machine, the Magic-Flow is the best system to ensure repeatability whilst complying with the toughest EPA legislation. Magic-Flow can be utilised with the Binks range of low or high pressure paint pumps along with Binks, DeVilbiss and Ransburg Spray Guns.

A wide range of fluid handling products, air controls and accessories

The reputation for outstanding reliability and performance is confirmed by the wide ranging industries worldwide that always specify Binks fluid handling products and DeVilbiss air regulator/filters and breathing systems and accessories. Each product has a proven operating pedigree with minimum maintenance and easy parts replacement. They are engineered to exacting standards from the finest materials including the highest grade Stainless Steel for total compatibility with the difficult to handle and water based materials. We leave nothing to chance, which is why we have our own dedicated Spray Booth filter media factory in Scotland. The Binks and DeVilbiss products depicted in this section of the catalogue include; Air and Fluid Regulators, Operator Air Fed Visors, Air and Fluid Hoses, Pressure Feed Tanks, Paint Agitators and Spray Booth Filter Paper.

Applications

- Aircraft and Aerospace Industry
- Automotive (OEM and Tier 1)
- Agricultural and Farming Machinery
- Defence and Military Fighting Vehicles
- Furniture, Woodworking and Joinery
- General Industry
- Leather Goods and Shoe Makers
- Marine and Boating Industry
- Off-road Vehicles and Fork Lift Trucks
- Rail and Transport
- Ship Building and Shipyards
- Truck and Bus
- Trailer/Chassis, plus many others.

Compatible Material/Coating Types

- Solvent and Water Based Materials
- Compliant/High Solids Coatings
- Adhesives
- Primers, Enamels and 2K Polyurethanes
- Fillers, Sealers and Lacquers
- Cellulose
- Pre-catalysed
- Acid Catalysed
- U.V. Curing Sealers and Topcoats
- Stains and Varnishes
- Release Agents
- Twin Pack Materials (2K)
- Anti-corrosive paints, plus many others.





Super lightweight and greater flexibility for better operator comfort.

BINKS MX LITE
HIGH PRESSURE PAINT PUMPS

5:1, 12:1, 31:1 and 32:1 Air Assisted Airless and Airless Spray Packages

The Binks MX LITE spray packages include the Binks Stainless Steel MXL high pressure pumps with Binks AA4400M Air Assisted Airless or A75 Airless Spray Guns.

MX Pump features include:

- Patented Air Valve Technology – Enables pump to change over quickly to significantly reduce pulsation
- Long Lasting Ceramic Coated Piston Rods – Superior wear resistance lasting up to three times longer than hard chrome pistons
- Designed To Pump Longer With Less Downtime & Extended Packing Life – Self-adjusting spring loaded fixed packings

Quality Passport for Binks MX-Pumps:

Modular construction means reduced number of parts for easy and fast maintenance.

- All wetted parts are Stainless Steel—Ideal for use with solvent and water based paints/materials
- Fixed, spring tension packings—Lower maintenance and reduced running costs
- All valve seats are Tungsten Carbide – Long durable working life

MX LITE outfits have been designed to provide users with a low cost, robust industrial spray outfit, able to apply a wide range of industrial coatings whilst providing the very best quality of spray finish.

- last up to 3X longer than the competition. Large sight glass for visual packing inspection
- Air Assisted Airless HVLP & A75 guns provide the latest atomisation technology
- Stainless Steel system – pump and gun
- 5 Year Limited Warranty – Best in class warranty for finishing equipment. Manufactured to ISO9001.

- Ceramic coated piston—Extra wear resistance, longer packing life
- Pump packings PTFE/UHMWPE mix (other packing choices available).

MXL4/12 – Airless & Air Assisted Airless Packages

SPECIFICATION	
Ratio	12:1
Max. Inlet Pressure	8.0 bar (116 psi)
Flow Rate Nominal	1.4 l/m
Flow Rate Max.	4.0 l/m
Volume/Cycle	24 cm ³
Max. Operating Pressure	96 bar (1390 psi)
Cylinder Diameter	55 mm
Piston Stroke	75 mm
Air Consumption	62.5 l/min

Mounting types available: Pail/tripod/wall/cart and gravity hopper feed.



Gravity feed option.

2 4



MXL412PU-T-ACG
– tripod mounted AAA outfit

MXL4/32 – Airless & Air Assisted Airless Packages

SPECIFICATION	
Ratio	32:1
Max. Inlet Pressure	8.0 bar (116 psi)
Flow Rate Nominal	1.4 l/m
Flow Rate Max.	4.0 l/m
Volume/Cycle	24 cm ³
Max. Operating Pressure	256 bar (3712 psi)
Cylinder Diameter	85 mm
Piston Stroke	75 mm
Air Consumption	147 l/min

Mounting types available: Pail/tripod/wall/cart and gravity hopper feed..



Gravity feed option.

2 4

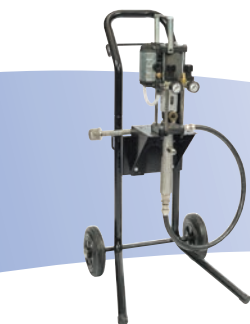

MXL432PU- C-AC
– cart mounted AAA outfit

MXL12/12 – Airless & Air Assisted Airless Packages

SPECIFICATION	
Ratio	12:1
Max. Inlet Pressure	8.0 bar (116 psi)
Flow Rate Nominal	4.3 l/m
Flow Rate Max.	12.0 l/m
Volume/Cycle	72 cm ³
Max. Operating Pressure	96 bar (1390 psi)
Cylinder Diameter	85 mm
Piston Stroke	75 mm
Air Consumption	147 l/min

Mounting types available: Cart and wall.

2 4

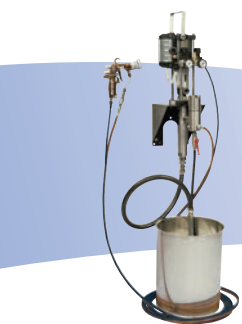

MXL1212PU-W-F-ACG
– wall mounted AAA outfit

HIGH PRESSURE PAINT PUMPS

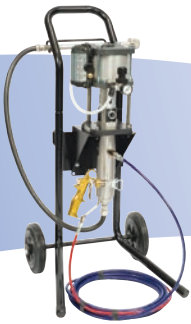

MXL12/31 – Airless & Air Assisted Airless Packages

2 4

SPECIFICATION	
Ratio	31:1
Max. Inlet Pressure	8.0 bar (116 psi)
Flow Rate Nominal	4.3 l/m
Flow Rate Max.	12.0 l/m
Volume/Cycle	72 cm ³
Max. Operating Pressure	248 bar (3596 psi)
Cylinder Diameter	140 mm
Piston Stroke	75 mm
Air Consumption	498 l/min

Mounting types available: Cart and wall.

MXL1231PU-C-ACG – cart mounted AAA outfit



Choose the Binks MXL Pump Outfit for your application from the chart below:

Binks MX Pump outfit Contents and Part Numbers	MXL412PU-T-AC	MXL412PU-W-AC	MXL412PU-T-F-ACG	MXL412PU-T-FG-ACG	MXL432PU-T-AC	MXL432PU-T-ACG	MXL432PU-T-F-ACG	MXL432PU-T-G-ACG	MXL432PU-T-FG-ACG	MXL432PU-W-AC	MXL432PU-W-F-AC	MXL432PU-W-F-ACG	MXL432PU-W-FG-ACG	MXL432PU-C-F-ACG	MXL432PU-C-FG-ACG	MXL432PU-P-F-AC	MXL1212PU-W-F-AC	MXL1212PU-C-ACG	MXL1231PU-W-F-AC	MXL1231PU-W-ACG	MXL1231PU-W-F-ACG	MXL1231PU-C-AC	MXL1231PU-C-F-AC	MXL1231PU-C-F-ACG	MXL1231PU-W-F-AL	MXL1231PU-W-ALG	MXL1231-W-F-ALG	MXL1231PU-C-F-AL	
MXL 4/12 Bare Pump	■	■	■	■																									
MXL 4/32 Bare Pump																													
MXL 12/12 Bare Pump																	■	■											
MXL 12/31 Bare Pump																					■	■	■	■	■	■	■	■	■
High pressure filter assy St St				■	■				■																				
Pail Mounted																													
Tripod Mounted	■		■	■	■	■	■	■	■																				
Cart Mounted																													
Wall Mounted		■																											
Airless controls																													
Air Assisted Airless controls	■	■	■	■	■	■	■	■	■	■	■	■	■	■	■	■	■	■	■	■	■	■	■	■	■	■	■	■	■
St St metal suction pipe/filter	■		■		■	■																							
Flexible suction hose assy & filter		■																											
Gravity Hopper (6 litre)				■																									
Hose & Gun			■	■	■	■	■	■	■	■	■	■	■	■	■	■	■	■	■	■	■	■	■	■	■	■	■	■	■

Binks MXL pump outfits are fully assembled, tested and ready to spray.

MX LITE Packages include:- Binks MXL pump mounted on tripod/wall/cart/pail with gun, air and pump fluid controls. 7.5 metre Air and Fluid Hoses. AA4400M* or A75 Spray Gun and Tip with gun mounted stainless steel edge type fluid filter.

(*Tip size to be specified at time of order)

Gun Specification	AA4400M	A75
Air/fluid inlet thread	1/4" Universal (M)	1/4" NPS
Fluid passageways	Stainless Steel	Stainless Steel
Gun weight	490g	660g
Gun body	Forged Aluminium	Anodised Aluminium
Max working fluid pressure	303 bar (4400 psi)	571 bar (7500 psi)
Max air inlet pressure	6.9 bar (100 psi)	-
Seat	Tungsten Carbide	-
Stainless steel inline paint filter	100 mesh	-



The unique Binks AA10 HVLP (54-5890K) air cap atomises at lower air pressures to provide the highest transfer efficiency with best finish.



Pt. No. 0909-4400-10000E AA4400M AAA GUN with AA10 Air Cap



Airless 75 with External Stainless Steel Tube - Pt. No. 0811 - 7500 - 1



Premium fine finish and twist tip range available

Standard pump packings PTFE/UHMWPE (other options are available – select from the MX pump service bulletin).

LOW PRESSURE PAINT PUMP



MXL12/05 – Low Pressure Paint Pump

2 4

SPECIFICATION	
Ratio	4.8:1
Max. Inlet Pressure	8.0 bar (116 psi)
Flow Rate	4.3 l/m
Flow Rate Nominal	0.72 l/m
Volume/Cycle	72 cc
Max. Fluid Pressure	38.4 bar
Cylinder Diameter	55 mm
Piston Stroke	75 mm
Air Consumption	62.5 l/min max

Mounting types available: Cart and wall.

MXL1205PU

Binks MX 1205 Pump Contents and Part Number	MXL1205UCU	MXL1205PU	MXL1205UCU-C-AC	MXL1205UCU-C-ACG	MXL1205UCU-C-F-AC	MXL1205UCU-C-F-ACG	MXL1205UCU_W-AC	MXL1205UCU-W-ACG	MXL1205UCU-W-F-AC	MXL1205UCU-W-F-ACG
MX 1205 Bare Pump	■	■	■	■	■	■	■	■	■	■
St St Filter Assembly										
Suction Hose Assembly										
Air Assisted Airless Controls										
Hose & Gun										
Cart Mounted										
Wall Mounted										

1 Tips/needles = Stainless Steel as standard 2 Stainless Steel fluid passageways 3 Optional = Tungsten Carbide and hardened tips/needles 4 Substrate = Wood, metal, plastic and others 5 Substrate = Ceramic and glaze



MX22035PU-SAH-CAC – cart mounted AAA outfit

Binks MX35/36 – Airless & Air Assisted Airless Packages

2 4

Pump Specification	MX 35/36
Ratio	36:1
Max. Inlet Pressure	8.0 bar (116 psi)
Flow Rate @ 15 cycles (continuous)	3.3 l/min
Flow Rate @ 30 cycles (intermittent)	6.6 l/min
Volume/Cycle	220 ml
Max. Fluid Pressure	288 bar (4176 psi)
Cylinder Diameter	200 mm
Piston Stroke	127 mm
Noise Level	*82.9 dB(A)
Air Consumption @ 20 cycles/min	1132 l/m (40 SCFM)

*Noise level recorded whilst pump was running at 100psi (7 BAR) @ 30 cycles per minute.



Binks MX30/42, MX35/60 and MX30/70 – Airless Packages

2 4

Pump Specification	MX 30/42	MX 30/60	MX 30/70
Ratio	42:1	60:1	70:1
Max. Inlet Pressure	7.0 bar (101.5 psi)	8.0 bar (116 psi)	7.0 bar (101.5 psi)
Flow Rate @ 15 cycles (continuous)	2.85 l/min	3.3 l/min	2.85 l/min
Flow Rate @ 30 cycles (intermittent)	5.7 l/min	6.6 l/min	5.7 l/min
Volume/Cycle	190 ml	220 ml	190 ml
Max. Fluid Pressure	294 bar (4263 psi)	480 bar (6960 psi)	490 bar (7105 psi)
Cylinder Diameter	200 mm	260 mm	260 mm
Piston Stroke	127 mm	127 mm	127 mm
Noise Level	*82.9 dB(A)	*80.7 dB(A)	*80.7 dB(A)
Air Consumption @ 20 cycles/min	1132 l/m (40 SCFM)	1985 l/m (70.1 SCFM)	1792 l/m (63.3 SCFM)

*Noise level recorded whilst pump was running at 100psi (7 BAR) @ 30 cycles per minute.

**Guns and hoses are not included in these packages:
Select gun/hose packages on page 21/22.**



MX22060PU-SAH-WAL – wall mounted Airless outfit

MX19070PU-SAK-CAL – cart mounted Airless outfit with optional bull bar hose bracket and quick knock off valve

BINKS MX Pump Outfit contents and part numbers

	MX22036PU-SAH-CAL	MX22036PU-SAH-WAL	MX22036PU-SAH-CAC	MX22036PU-SAH-WAC	MX19042PU-SAH-CAL	MX19042PU-SAH-WAL	MX22060PU-SAH-CAL	MX22060PU-SAH-WAL	MX19070PU-SAH-CAL	MX19070PU-SAH-WAL
Bare Pump MX 35/36 (36:1 ratio / 220 cc/cycle)	■	■	■	■						
Bare Pump MX 30/42 (42:1 ratio / 190 cc/cycle)					■	■				
Bare Pump MX 35/60 (60:1 ratio / 220 cc/cycle)							■	■		
Bare Pump MX 30/70 (70:1 ratio / 190 cc/cycle)									■	■
High Pressure Stainless Steel Filter	■	■	■	■	■	■	■	■	■	■
Cart Mounted	■		■		■		■		■	
Wall Mounted		■		■		■		■		■
Airless Controls	■	■			■	■	■	■	■	■
Air Assisted Airless Controls			■	■						
Flexible suction hose assembly with 30 MESH strainer	■	■	■	■	■	■	■	■	■	■



Binks Heated Hoses

4

- Hose Specification
 - Inner 6/8mm ID PTFE Fluid Hose with Stainless Steel Braiding
 - Heat Insulation
 - Antistatic outer sheath
 - Outer diameter 43/55mm
 - 1/4" or 3/8" Female cone fittings
 - 5m long connection cables
 - Available in 10M and 15M lengths

- For Fixed Installation
- High Pressure and low pressure applications
- ATEX - For use in hazardous areas (except temp. controller)
- PT100 / 3 wire temperature sensor 230V / 50Hz
- Min Ambient Temperature -20°C
- Max Temperature 120°C
- Designed to maintain temperature of 30°C



Temperature Controller H-76-CTR

Part No.	Description	Inner Diameter (mm)	Length (m)	Fittings (")	Max working pressure (Bar)
H-76-06-240-10	10mm hose for LP and up to 240 Bar with 1/4" conns	6	10	1/4	240
H-76-06-500-10	10mm hose up to 500 Bar with 1/4" conns	6	10	1/4	500
H-76-08-250-10	10mm hose up to 250 Bar with 3/8" conns	8	10	3/8	250
H-76-08-250-15	15mm hose assembly 250 Bar with 3/8" conns	8	15	3/8	250
H-76-08-475-10	10mm hose assembly 475 Bar with 3/8" conns	8	10	3/8	475
H-76-08-475-15	15mm hose assembly 475 Bar with 3/8" conns	8	15	3/8	475
H-76-CTR	*Temp controller with digital display				

*Temp controller needed with all hose assemblies. Controller to be fitted in non hazardous area.

HIGH PRESSURE PAINT PUMPS

MX Pump Outfit Accessories

2 4

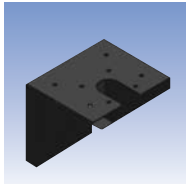

1 Wall Bracket

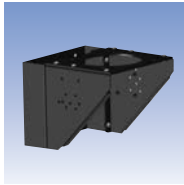

2 Wall Bracket



3 Cart Assembly



4 Cart Assembly



5 Tripod Assembly



6 Lubricating Oil

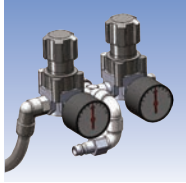

7 Air Controls



8 Air Regulator



9 Fluid Filter

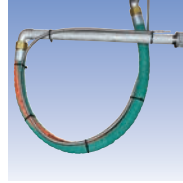

10 Suction Hoses



11 Hose Storage Bracket



12 Airless Hoses

1 Wall Bracket

Part Number	Description	Pump
0115-010179	Wall Bracket	MXL4/12 - MXL4/32 - MXL12/12 - MXL12/31

2 Wall Bracket

Part Number	Description	Pump
104095	Wall Bracket	MX35/60 - MX30/70
104116	Wall Bracket	MX35/36 - MX30/42

3 Cart Assembly

Part Number	Description	Pump
0115-010186	Cart Assembly	MXL4/12 - MXL4/32 - MXL12/12 - MXL12/31

4 Cart Assembly

Part Number	Description	Pump
104084	Cart Assembly	MX35/36 - MX30/42 - MX35/60 - MX30/70

5 Tripod Assembly

Part Number	Description	Pump
0115-010100	Tripod Assembly	MXL4/12 - MXL4/32

6 Lubricating Oil

Part Number	Description	Pump
0114-016099	Water Based 0.25 l	All MX Pumps
0114-016100	Solvent Based 0.25 l	All MX Pumps
0114-014871	Water Based 0.5 l	All MX Pumps
0114-009433	Solvent Based 0.5 l	All MX Pumps

7 Air Controls

Part Number	Description	Pump
0115-010664	Air Controls – AAA	MXL4/12 - MXL4/32 - MXL12/12 - MXL12/31
0115-010198	Air Controls – Airless	MXL4/32 - MXL12/31

8 Air Regulator

Part Number	Description	Pump
MXA-C13ALM5- H34	Air Control regulator filter – Airless	MX35/36 - MX30/42 - MX35/60 - MX30/70
MXA-C13ACM5-H34	Air Controls – Airless	MX35/36 - MX30/42 - MX35/60 - MX30/70

9 Fluid Filter

Part Number	Description	Pump
0115-010711	Type 1	MXL4/12 - MXL4/32 - MXL12/12 - MXL12/31
0110-009130	Type 3	MXL4/12 - MXL4/32 - MXL12/12 - MXL12/31
0110-011760	Type 11	MX35/36 - MX30/42 - MX35/60 - MX30/70

10 Suction Hoses

Part Number	Description	Pump
0115-010696	Suction Hose - 25 l 30 mesh	MXL4/12 - MXL4/32 - MXL12/12 - MXL12/31
0115-010381	Suction Hose - 200 l 30 mesh	MXL4/12 - MXL4/32 - MXL12/12 - MXL12/31
0115-010699	Tripod Inlet Tube 50 mesh	MXL4/12 - MXL4/32
MXA-S25ME30-DH114	Suction Hose - 25 l 30 mesh	MX35/36 - MX30/42 - MX35/60 - MX30/70
MXA-S210ME30-DH114	Suction Hose - 210 l 30 mesh	MX35/36 - MX30/42 - MX35/60 - MX30/70

Silencer

Part Number	Description	Pump
192509	Silencer	MX35/36 - MX30/42 - MX35/60 - MX30/70

11 Hose Storage Bracket

Part Number	Description	Pump
193381	Optional hose storage bracket for cart and wall assembly	MX35/36 - MX30/42 - MX35/60 - MX30/70

12 Airless Hoses

Part Number	Description	Pump
H-5850	1.8m Airless whip end 1/4" bore with 1/4" NPS connectors (500 BAR)	MX35/36 - MX30/42 - MX35/60 - MX30/70
H-5851	1m Airless whip end 1/4" bore with 1/4" NPS connectors (500 BAR)	MX35/36 - MX30/42 - MX35/60 - MX30/70
H-5852	15m Airless hose assembly 1/4" bore with 1/4" NPS connectors (500 BAR)	MX35/36 - MX30/42 - MX35/60 - MX30/70
H-5853	15m Airless hose assembly 3/8" bore with 3/8" NPS connectors (500 BAR)	MX35/36 - MX30/42 - MX35/60 - MX30/70
74-011/1	1/4" x 1/4" D.M nipple to join 2 x 1/4" NPS HP hoses	MX35/36 - MX30/42 - MX35/60 - MX30/70
74-011/1	1/4" x 3/8" D.M nipple to join 1/4" NPS x 3/8" NPS HP hoses	MX35/36 - MX30/42 - MX35/60 - MX30/70

BINKS DX70
AIR OPERATED 1:1 DIAPHRAGM PUMPS

DX70 is the perfect solution for one or two spray gun applications with faster colour changes and quick refills for less production downtime.

- Acetal pump body with st. st. balls and soft seats for universal paint compatibility including ceramic glaze coatings
- The unique diaphragm design and “built in” fluid regulator provide consistent pressure and readily adjustable paint flow
- The Non-stall air valve provides smooth, quiet and surge free paint delivery up to 1000 cc/ minute
- Clearly labelled Air regulators provide independent control of pump and spray gun fluid and air pressures
- Quick release air, fluid inlet and outlet connections for faster maintenance
- Re-circulation/dump valve accessory for faster colour changes reducing down time, saving time and money
- Pump outfit mountings include Cart, Wall, 25L Pail and Tripod outfits with or without spray guns and hoses
- Outfits with Fluid filter are available for finer paint finishes.

The Binks DX70 is a high specification, air powered 1:1 ratio double diaphragm pump specifically developed for the direct supply of paints and materials to spray guns. The pump features a unique diaphragm no-crease shape for a long and durable working life DX70 also includes a “built-in” fluid regulator which ensures a constant and virtually pulse free fluid delivery, for direct feed to spray guns without the expense and complications of an additional fluid regulator or surge chamber.

The Binks DX70 range features bare pumps, assembled pump packages and complete “ready to spray” outfits matched with our World renowned DeVilbiss spray guns. DX70 is perfect for use with ALL TYPES of spray gun technologies including, Conventional, Compliant Trans-Tech®, HVLP, LVLP and low pressure Electrostatic guns. Binks DX70 is the low cost solution compared to pressure tanks with no expensive annual pressure test certification regulations.

*The standard pump without fluid regulator can also be used on ceramic glaze applications.

Specifications

DX70 Pump Specification (Bare Pump)	
Pump Ratio	1 : 1
Max. Air Pressure	7 Bar / 100 PSI
Max. Fluid Pressure	7 Bar / 100 PSI
Nominal Flow Volume / Cycle	0.07 Litres (0.018 US Gall)
Fluid Output @ 60 cycles/min	4.2 Litres / min (1.1 US Gall / min)
Max Recommended Continuous Cycle Rate	10 Cycles /min
Max Recommended Intermittent Cycle Rate	30 Cycles /min
Inlet Fluid Connection	3/8" Universal (BSPP/NPSM) Male or Female
Outlet Fluid Connection	3/8" Universal (BSPP/NPSM) Male or Female
Maximum Dry/Wet Lift	6.6 m (21.8 feet)
Air Inlet	G1/4" (BSPP) Female
Fluid Regulator Pilot	Ø4 Tube
Air Volume / cycle @ 6.9Bar/100psi	0.77 L (0.027SCFM)
Air Flow @ 10 cycles/min 6.9 bar/100psi	7.7 L/min (0.27SCFM/min)
Air Flow @ 30 cycles/min 6.9 bar/100psi	23.2 L/min (0.82SCFM/min)
Air Quality ISO 8573.1 Class 3.3.2 #	Dirt 5 microns
	Water -20°C@7bar (940ppm)
	Oil 0.1mg/m ³
	Non Lubricated
Noise Level	68 db LAeq
Earth (Air Inlet Cover)	<1Ω
Weight – Bare Pump	2.2 Kg (4.9 lbs)

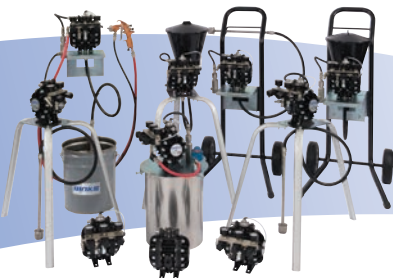

DX70R-MM3



DX70N-MM2

The standard pump without fluid regulator can also be used on ceramic glaze applications.

DX70 Bare Pumps Contents and Part Numbers	DX70R-MM3	DX70R-MF3	DX70R-FM3	DX70R-FF3	DX70N-MM2	DX70N-MF2	DX70N-FM2	DX70N-FF2	DX70N-MM1	DX70N-MF1	DX70N-FM1	DX70N-FF1	DX70R-MM	DX70R-MF	DX70R-FM	DX70R-FF	DX70N-MM	DX70N-MF	DX70N-FM	DX70N-FF
DX70 Bare Pump Regulated M/M	●												●							
DX70 Bare Pump Regulated M/F		●												●						
DX70 Bare Pump Regulated F/M			●												●					
DX70 Bare Pump Regulated F/F				●												●				
DX70 Bare Pump No Reg M/M					●				●								●			
DX70 Bare Pump No Reg M/F						●				●								●		
DX70 Bare Pump No Reg F/M							●				●								●	
DX70 Bare Pump No Reg F/F								●				●								●
Air Controls - 3 Regulators	●	●	●	●																
Air Controls - 2 Regulators					●	●	●	●												
Air Controls - 1 Regulators									●	●	●	●								



BINKS DX200
AIR OPERATED 1:1 RATIO DIAPHRAGM PUMPS

DX200 is designed specifically for finishing applications requiring multi-spray gun usage, or while transferring or circulating up to 5 l/pm of high to low viscosity materials.

The DX200 is a high flow rate, air operated 1:1 ratio, double diaphragm circulation or transfer pump specifically developed for the direct supply of paints and materials to spray guns.

The pump features a unique “no crease” diaphragm shape for a long and durable working life. Users can opt for the “built-in” fluid regulator which ensures a constant and virtually pulse free fluid delivery, enabling direct connection to spray guns without the expense and complications of an additional fluid regulator or surge chamber.

The DX200 range features bare pumps and a choice of outfits. DX200 is self-priming and perfect for use with ALL TYPES of spray gun technologies including, Conventional, Compliant Trans-Tech®, HVLP, LVLP and low pressure Electrostatic guns.

- Rugged Construction & Universal Material Compatibility. Available in Aluminium and Stainless Steel to handle a wide variety of fluids.
- Non-Stall & Quiet Running. A non-stall air valve and integrated muffler provides smooth, quiet running.
- Extended Service Life & Zero Leakage. Bonded PTFE diaphragm is more flexible, removing mechanical seals or packings, which means an extended service life.
- Consistent Fluid Delivery. Unique “no-crease” diaphragm design and “built-in” fluid regulator ensures a consistent pressure output and significantly reduced pulsation.
- Pumps Shear-Sensitive Materials. Low internal velocities and gentle pumping action does not shear coatings.
- Fast & Easy Servicing. Pump body provides unobstructed access to air valve and diaphragms for fast and easy maintenance without the need to dismantle the pump.

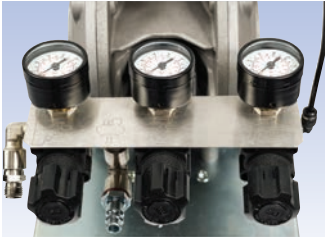

DX200 Pump Specification (Bare Pump)	
Ratio	1:1
Max Air Pressure	7.0 bar (100 psi)
Max Fluid Pressure	7.0 bar (100 psi)
Nominal Flow Volume / Cycle	0.20 Litres (0.05 US Gall)
Fluid Output @ 60 Cycles/Min	12 l/min (3.17 US Gall/min)
Max Recommended Continuous Cycle Rate	25 Cycles /min
Max Recommended Intermittent Cycle Rate	60 Cycles /min
Inlet Fluid Connection	3/4" BSPP Female
Outlet Fluid Connection DX200A*/DX200S*	3/4" / 1/2" BSPP Female
Maximum Dry/Wet Lift (Head)	4.6m (15.1ft) / 7.5m (24.6ft)
Air Inlet	G 1/4" (BSPP) Female
Fluid Regulator Pilot	Ø4 Tube
Air Volume / cycle @ 6.9Bar/100psi	2.83l (0.1 SCFM)
Air Flow @ 10 cycles / min 6.9Bar/100psi	28.3l (1 SCFM)
Air Flow @ 30 cycles / min 6.9Bar/100psi	84.9l (3 SCFM)
Air Quality ISO 8573.1 Class 3.3.2 #	Dirt 5 microns Water -20°C @ 7Bar (940ppm) Oil 0.1mg/m³ Non Lubricated
Noise Level	71.2 dBA Leq
Weight - Bare Pump	9.5Kg (20.94 lbs)
Pump Body	Aluminium Anodised or St St

DX 200A Parts and Service kits

Part No	Description
DXK-201	Check Valve Seal Kit x 4
DXK-202	Check Valve Kit x 4
DXK-203	Diaphragm Kit x 2
DXK-204	Shaft & Seal kit
DXK-205	End Cap Seal Kit x 2
DXK-206	Caps and screws x 2
DXK-207	End Cap Bolts x 12
DXK-208	End Cap (including DXK-205, end cap seal kit)

Easy To Use

Outfits include clearly identified air regulators which can independently control the pump, fluid delivery pressures and spray gun.

Save Costs

The “built-in” fluid regulator can save money compared to competitive products. Low internal pump volumes minimise fluid wastage during flushes.

Mounting Options

Pump outfits include a mounting option and are fitted with a flexible suction wand and suction strainer on the vertical bottom inlet. A rigid suction tube is used when pail mounted. The unregulated model has a vertical top outlet, while the fluid regulated model is a front horizontal outlet.

Easy To Service

The end cap and air valve cover fixings are unobstructed and can be removed with a single tool, enabling pump maintenance to be performed wherever it is located.



Unregulated DX200A provides users with a vertical fluid outlet.



“Built-in” fluid regulator saves money compared with competitive products.



Stainless Steel model with Surge Chamber (for applications where fluid filter will shear fluid). Order DX200SP.



A range of connectors are available to allow connection of the pump inlet/outlet to different system connections.

MAPLE PUMPS

2 4

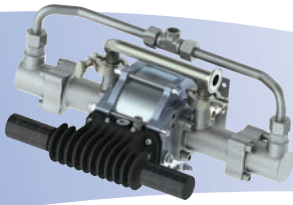

Maple 7/15



The Maple Pump is our advanced, air operated, horizontal piston pump for automotive and general industrial applications. This range of precision engineered pumps is designed to handle modern shear sensitive solvent and waterborne paints as well as pure solvents and other paint shop materials. The Maple Pump design combines an energy efficient air motor with our low shear fluid section technology providing a smooth consistent flow of material for both automatic and manual spray gun systems.

- Low Ice lubricant free air motor with patented quick exhaust technology removes the risk of valve icing.
- Enclosed Bellows Seals - no exposed seals eliminating shaft packing lubrication and significantly reducing pump maintenance.

- Stainless steel fluid sections, ideal for waterborne, or solvent based paints.
- Tungsten Carbide ball seats and ceramic coated pistons ensure maximum, trouble free operating life.
- Equal thrust on each stroke produces a smooth, even paint flow.
- Control valve metal spool and sleeve for long life, incorporating our patented magnetic detent to eliminate stall conditions.
- Fluid connections guarantee a smooth internal flow and eliminate paint pockets for to ensure a superior finish.
- 5 year pump warranty on materials and workmanship.

Specifications

Model number	Maple 15/3	15/3 AFP 'Easi Flush'	Maple 30/3	Maple 60/3	Maple 7/7	Maple 7/15	Maple 8/25
Part No	104009	104129	104010	104020-M2	104040	104041	104042
Ratio	3:1	3:1	3:1	3:1	7:1	15:1	25:1
Fluid output @ 60 cycles/min	22.5 L/min	22.5 L/min	45 L/min	90 L/min	10 L/min	10 L/min	12 L/min
Max continuous cycle rate	20 cycles /min						
Max intermittent cycle rate	40 cycles /min						
Fluid connections							
Inlet	1" Sanitary	1" Sanitary	1½" Sanitary	1½" Sanitary	1" Sanitary	1" Sanitary	1" Sanitary
Outlet	1" Sanitary	¾" Sanitary	1½" Sanitary	1½" Sanitary	½" NPT Female	½" NPT Female	½" NPT Female
Max air inlet pressure	7 bar (102 psi)						
Compressed air inlet	3/8" BSPP / NPSM	3/8" BSPP / NPSM	3/8" BSPP / NPSM	½" BSPP / NPSM	3/8" BSPP / NPSM	3/8" BSPP / NPSM	½" BSPP / NPSM
Air volume / cycle							
@3.1bar 45psi	4.8 L/min	4.8 L/min	9.5 L/min	19.8 L/min	4.8 L/min	9.5 L/min	19.8 L/min
@6.2bar 90psi	9.3 L/min	9.3 L/min	18.5 L/min	39.7 L/min	9.3 L/min	18.5 L/min	39.7 L/min
Weight	21 kg (46lb)	25 kg (55lb)	35 kg (77lb)	65 kg (143lb)	20 kg (44lb)	30 kg (66lb)	40 kg (88lb)
Service Kits (Part No's)							
Fluid piston seal kit	250625	250714	250608	250632	250653	250653	250653
Fluid sect'n overhaul kit	250626	250715	250619	250633	250655	250655	250654
Air motor seal kit	250627	250627	250618	250634	250695	250657	250656
Control valve kit	250628	250628	250620	250635	250628		

Further technical information can be found in the individual pump service manuals.

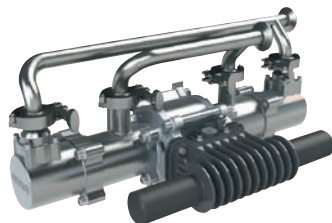

Maple 15/3



Maple 15/3 AFP 'Easi Flush'

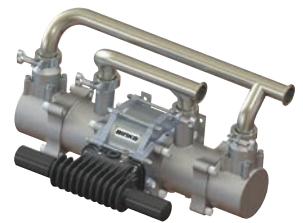

Maple 30/3

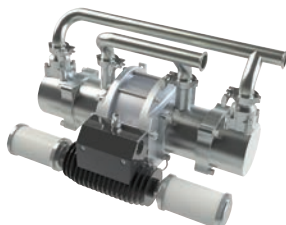

Maple 60/3



Maple 7/7

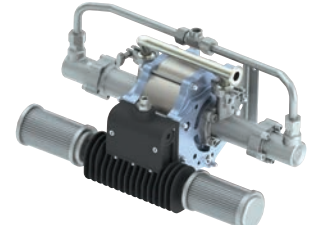

Maple 8/25

SMART PUMPS



Binks Smart Pumps are respected for their energy efficiency and proven reliability. This is why they are found at the heart of the world’s largest Automotive and Industrial paint systems. Our market leading pumps combine digitally controlled AC motors with our patented horizontal reciprocating drive fluid sections. The result is a circulating pump which uses a fraction of the energy of pneumatic pumps, yet still treats modern sheer sensitive paints with kid gloves.

Binks Smart pumps are more efficient than competitor pumps due to their patented design, but when combined with our ground breaking smart system, even higher savings can be obtained. Utilising pressure monitoring and digital control, the Binks Smart System ensures that material is delivered to the point of application only when needed, dramatically reducing energy and paint consumption.

- Significant Energy Savings – Electric drive linked with Smart Control gives significant energy and cost savings over pneumatic pumps
- Patented reciprocating drive with asymmetric CV Cam, minimises pressure fluctuations so no surge chamber required.
- Flow rate control by AC frequency inverter allows fine speed adjustment within a 10 to 40 cycles per minute range
- Long life piston seals and enclosed PTFE shaft bellow seals give longer component working life and minimise maintenance requirements.

Specifications

Smart Pump Model number	E2-15	E2-15 AFP 'Easi Flush'	E2-30	E2-40	E2-60	E4-60
Part No	104017	104125	107071	107093	104085	107070
Max Fluid Pressure	20 bar (290psi)	20 bar (290psi)	20 bar (290psi)	16 bar (232psi)	16 bar (232psi)	20 bar (290psi)
Max Inlet Pressure	2 bar (29psi)	7 bar (100psi)	2 bar (29psi)	2 bar (29psi)	2 bar (29psi)	2 bar (29psi)
Fluid Output						
@ 20Hz (10 cycles/min)	3.75 L/min	3.75 L/min	3.75 L/min	10 L/min	15 L/min	15 L/min
@ 80Hz (40 cycles/min)	15 L/min	15 L/min	15 L/min	40 L/min	60 L/min	60 L/min
Fluid connections	1" Sanitary	1" Sanitary	1" Sanitary	1½" Sanitary	1½" Sanitary	2" Sanitary
Total Pump Weight	78 kg (172 lbs)	80 kg (176 lbs)	250 kg (550 lbs)	250 kg (550 lbs)	295 kg (651 lbs)	350 kg (550 lbs)
Service Kits (Part No's)						
Fluid Piston Seal kit	250625	250714	250608	250621	250686	250601
Wet section overhaul kit	250641	250716	250610	250622	250687	250596
Main bearing overhaul kit	250642	250642	250599	250599	250683	250599

Further technical information can be found in the individual pump service manuals

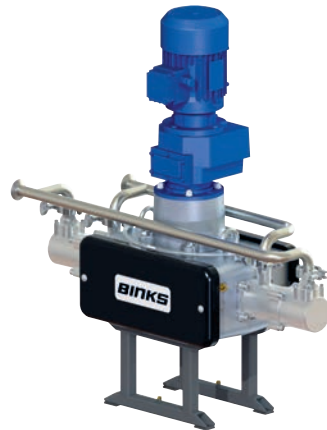

E2-15



E2-15 AFP 'Easi Flush'



E2-30



E2-40



E2-60



E4-60

PILOT CONTROLLED HIGH PRESSURE / BACK PRESSURE REGULATORS 4

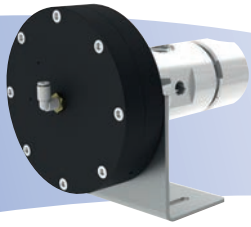

Our advanced high pressure and back pressure regulators are designed to handle the pressures required for controlling medium to high viscosity materials used in today's automotive and industrial applications. Typical material applications include High Viscosity PVC, Underseals, sound deadeners, anti-flutter, adhesives and fillers.

- Low Maintenance due to small number of moving parts
- Compatible with solvent based and water based materials
- Pilot Controlled by regulated air supply
- Mounting bracket included

Specifications

Part Number	107906 (High Pressure regulator) 107908 (Back Pressure Regulator)
Working range	35 – 240 bar
Air Pilot range	0.7 – 5.5 bar
Connections	Inlet port 3/4" NPT Outlet port 3/4" NPT Gauge Port 1/4" NPT
Weight	6.8 kg

1 1/2" AND 3/4" PILOT CONTROLLED AND MANUAL PRESSURE REGULATORS 4



3/4"

Binks pressure regulators responds to the changes in system fluid pressure by dynamically adjusting so as to maintain the set pressure. They minimise paint shear through their large internal surface area and critically designed valve seatings. Binks pressure regulators are available in automatic (air pilot regulated) and manual adjustment models.

- Low Shear Back Pressure Regulators
- Reduced paint velocity through valve seat
- Two gauge port allows for flexible mounting
- Interchangeable connections inc:
 - M45 x 2" Sanitary, M45 x 1 1/2" Sanitary, M45 x 1" Sanitary
 - M28 x 1" Sanitary, M28, 3/4" NPT (female), M28 x 3/4" BSPT (female)

Specifications

Part Numbers	107755 (1 1/2" Air Pilot) 107754 (1 1/2" Manual) 107758 (3/4" Air Pilot) 107757 (3/4" Manual)
Working range	1 – 15 bar - 10 – 19 L/min (Air Pilot) 3 – 15 bar - 10 – 19 L/min (Manual)
Max Pressure	25 bar
Construction Materials – Body	303 grade Stainless Steel
Diaphragm	PTFE composite



1 1/2"

CARTRIDGE FILTERS 4



The Binks range of cartridge filters remove dirt and paint clots from paint systems using a choice of disposable or cleanable filters elements. They allow the rapid replacement of the elements with their "fixed in place" clamp design. The housing also provides an integral pressure gauge port to allow for the measurement of differential fluid pressure.

- Provides absolute rated filtration at 99.98% performance
- Housing constructed of 316 grade Stainless Steel, electro plated for ease of cleaning
- Accommodates industry standard DOE or Code 3 filter elements
- Range of sizes to accommodate different capacity paint circulating systems.

Part Number	Description
107874	5" Cartridge Filter Housing - 1" BSP Connections
107875	5" Cartridge Filter Housing - 1" Sanitary Connections
107871	10" Cartridge Filter Housing - 1" BSP Connections
107870	10" Cartridge Filter Housing - 1" Sanitary Connections
107868	10" Cartridge Filter Housing – 1 1/2" Sanitary Connections
107873	20" Cartridge Filter Housing – 1" Sanitary Connections
107869	20" Cartridge Filter Housing – 1 1/2" Sanitary Connections

PRESSURE RELIEF VALVES

4



The Binks mechanical pressure relief valve offers protection against damage from system overpressure. Our mechanical relief valves can be easily installed directly on the pump outlet manifold and if triggered will relieved paint system pressure by diverting flow back into the mix tank.

- Stainless steel construction.
- Standard Sanitary & hose connections.
- Ideal for quick installation to pump outlet
- 9 versions available for attachment to Binks range of pumps
- Minimal 'dead' area in paint flow line.

Specifications

Part Number	PRV22-U-10	1" Sanitary 3/4" Hose Outlet
	PRV22-U-15	1 1/2" Sanitary 3/4" Hose Outlet
	PRV22-U-20	2" Sanitary 3/4" Hose Outlet
	PRV22-S-10	1" Sanitary 1" Sanitary Outlet
	PRV22-S-15	1 1/2" Sanitary 1" Sanitary Outlet
	PRV22-S-20	2" Sanitary 1" Sanitary Outlet
	PRV22-N-10	1" Sanitary 3/4" NPT(F) Outlet
	PRV22-N-15	1 1/2" Sanitary 3/4" NPT(F) Outlet
	PRV22-N-20	2" Sanitary 3/4" NPT(F) Outlet
Relief Port Connection		3/4" Hose Connector 1" Sanitary 3/4" NPT(F)
Initial Activation Pressure		22 Bar (320 psi)
Full Activation Pressure		24 Bar (350 psi)

SURGE ELIMINATORS

4

Surge Eliminators eliminate the pressure fluctuation produced by reciprocating pumps on changeover. The units consist of a lower fluid and upper air chamber separated by a flexible moulded composite

diaphragm which absorbs the fluctuations and eliminates the paint surge, ensuring a smooth flow of paint to the applicator.

ACTIVE FLUSHABLE SURGE ELIMINATOR

4



The Active surge eliminator features an active air pilot valve which dynamically changes air pressure to automatically equal fluid pressure, thus eliminating manual compressed air charging.

- Flushable fluid chamber
- Fluid connection options available.
- Direct mounting to the paint pump.

Specifications

Part Number	104050-X		
Maximum Fluid Pressure	16 Bar (232 psi)		
Air Connection	1/8"		
Fluid Connection Fittings	Suffix	Part no	Description
	(X)		
	A	192553	Fitting - M45 x Slip Flange Assembly
	B	192554	Fitting - M45 x 2" Sanitary
	C	192555	Fitting - M45 x 1 1/2" Sanitary
	D	192556	Fitting - M45 x 1 1/2" NPT (Female)
	E	192557	Fitting - M45 x 1 1/2" BSPT (Female)
	F	192558	Fitting - M45 x 42 MM Compression Coupling
	G	192559	Fitting - M45 x 1 1/4" BSP (H)
	H	192560	Fitting - M45 x 1 1/2" BSP (H)
	L	192564	Fitting - M45 x 1" Sanitary

STANDARD AND STANDARD FLUSHABLE SURGE ELIMINATORS

4



Standard Surge Eliminators utilise a manually set charge of compressed air to set the required fluid pressure compensation level. The fluid chamber can

either be supplied with a conventional bottom entry connection or with a flushable flow through design.

Specifications

Part Number	104052-X		
Maximum Fluid Pressure	16 Bar (232 psi)		
Air Connection	1/4"		
Fluid Connection Fittings	Suffix	Part no	Description
	(X)		
	S	192723	Fitting - 1" Sanitary
	T	192724	Fitting - 3/4" NPT (Female)
	U	192725	Fitting - 3/4" BSPT (Female)



DR-1 FLUID REGULATOR

4

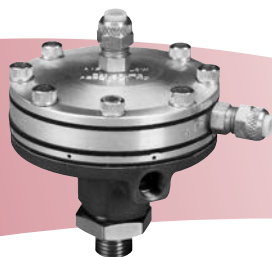

The Ransburg DR-1 Fluid Regulator provides constant fluid regulation for automatic coating application systems. It features two selectable fluid pressure ranges, low and high. The low flow range output provides precise fluid delivery control and the high flow range output accommodates higher fluid deliveries. The combination provides excellent paint film uniformity with minimal colour change time.

- Efficient Colour Change
- Dual low and/or high flow capacity
- Material savings with improved finish quality
- All stainless steel wetted parts with PTFE coated internal components.

Specifications

Part Number	74151
Dimensions	48mm (h) x 70mm Ø x 86mm (L)
Input fluid pressure	80 – 100 psi
Output Fluid Pressure	Variable by ratio
Pneumatic/Fluid connections:	
Air Pilot	¼" OD x 3/16" ID #10-32 thread
Fluid In	¼" NPSM
Fluid Out	1/8" NPSM
Ratio availability	1:1, 1:2, 1:3, 1:4, 1:6, 1:8, 1:10

CCV MODULAR COLOUR CHANGE SYSTEM

4

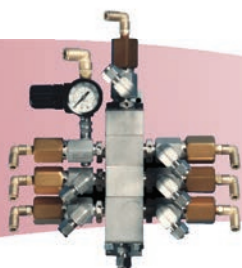

Ransburg's Modular Colour Change System incorporates a practical and flexible modular valve assembly, suitable for a variety of applications ranging from small industrial paint shops to major automotive OEM lines. All wetted parts are engineered for compatibility with today's coatings and the modular design allows for the changing needs of the fluid supply system.

- Proven Performance
- Compact Design
- Durable Stainless Steel Construction
- Modular Manifold Design.

Specifications

Part Number	CCV-17/-16/-18/-34/-38
Operating Pressure	4.8 – 6.9 Bar (70 – 100 psi)
Fluid Pressure	20.7 Bar (300 psi)
Air Inlet/Outlet connections	¼" OD (6mm)
Fluid Inlet	¼" NPT Female x 2 ports
Fluid Flow Capacity	3800 cc/min at 47psi pressure drop

MCV2 COLOUR CHANGE SYSTEM AND MCV2D DUAL PURGE COLOUR CHANGE SYSTEM

4

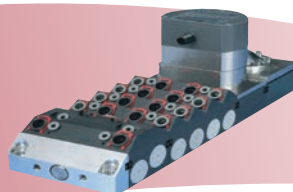

The MCV2 Colour Change System is designed to meet the stringent requirements of Automotive, Tier 1 and Industrial coatings systems. New insert-and-seal connections combined with the modular design provides quick and easy colour change no matter what the application. The MCV2D gives the added benefit of a Dual-Purge option for use with true Dual-Purge applicators. This allows cleaning of one line whilst at the same time spraying from another.

- Modular components allow scalability, up to 32 colours.
- Two o-ring seals between each block eliminate paint trap cavities.
- Piston Flag gives visual indication when valve is triggered
- Internal porting of the valve block significantly reduces paint shear
- Lightweight design is durable, corrosion resistant and built to last, even under rigorous continuous cyclical use.

Specifications

Part Number	A10800 (MCV2 metric), A11077 (MCV2 Imperial) A10986 (MCV2D metric), A10993 (MCV2D Imperial)
Fluid Operating Pressure	20.7 Bar (300 psi)
Air Actuating Pressure	4.9 Bar (70 psi)
Trigger tube size	5/32" (4mm)
Fluid Tube Size (OD)	10mm, 8mm (3/8", 5/16")



BINKS RAM UNITS

Binks Ram Units offer a rugged, reliable and high performance solution for the delivery of medium and high viscosity materials in both stand-alone and system applications. They incorporate the Binks MX range of high pressure piston pumps giving proven durability, reliability and performance.

Binks Ram Units provide the ideal delivery solution for materials such as lubricants, mastics adhesives, epoxies and sealants. Binks Ram Units can be customised to suit all application needs. The Ram follower plates are designed to fit the widest range of industry standard containers and a range of 32 (ball or chop-check) pumps can be specified to suit the material viscosity and flow rate.

- Units to suit industry standard 20, 30, 60, 120 and 205 litre containers.
- Dual Seal follower plates and stainless steel pump fluid sections as standard
- Incorporate Binks highly respected MX High Pressure pumps
- 2.5, 5, 8.3, and 22.6 KN downforce standard models available
- 1000 Litre Ram units available on custom order
- 5 year warranty on manufacturer defects.



Specification	
Maximum Working Air Pressure	6 bar / 87psi (SR, DR & DRi), 7 bar / 101psi (DRX)
Air Inlet	½" BSP F
Ram Stroke	SR20 410mm / 16" DR & DRi 20,30,60 688mm / 27" DR, DRi & DRX 120, 205 960mm / 37.8"
Unit Height – Fully extended	SR20 1242mm / 49" DR & DRi 20,30,60 1750 / 69" DR, DRi & DRX 120, 205 2550mm / 100"
Pump inlet valve types	Ball check Chop check (shovel plate)
Pump rod material types	Nitrided carbon steel Ceramic coated stainless steel



Ram Unit Pump Outfit Options

Equip your Ram Unit from our extensive range of durable, hard-working MX Pumps. (See back page for pump fluid output and pressure ratings)

Example Model Number: **DR 30 E -MX 115 68 PU - S M X** = 30l Dual Post Ram with MX11568 Chop Check pump

RAM SECTION

DR → RAM TYPE: Single post (SR), Dual post (DR) and extreme duty (DRX)

30 → DRUM VOLUME (Litre): 20, 30, 60, 205.

E → FOLLOWER PLATE SEAL MATERIAL: EDPM (E) or Polyurethane (P)

115 → PUMP FLUID OUTPUT / CYCLE (cc/cycle): 68, 115, 122, 190, 200, 220, 420, 440, 860, 880.

PUMP SECTION



68 → PUMP RATIO: Ball Check Pumps (15:1, 18:1, 22:1, 23:1, 30:1, 35:1, 41:1, 46:1, 60:1); Chop Check Pumps (5:1, 12:1, 18:1, 23:1, 24:1, 30:1, 33:1, 39:1, 43:1, 46:1, 66:1, 68:1).

PU → PUMP PACKING MATERIAL: PTFE & UHMWPE (PU)

S → PUMP ROD MATERIAL: Nitrided Carbon Steel (C) or Ceramic Coated Stainless (S) Steel

M → PACKING ADJUSTMENT: Manual (M) only

X → INLET VALVE TYPE: Ball-Check (B) or Chop-Check (X)



BINKS GEMS
2K ELECTRONIC MIXING SOLUTION



GEMS is the easy to operate 2K mixing solution that audits your paint resin and solvent usage while helping to reduce your solvent waste for up to 5 colours and 2 spray guns.

- Operator Friendly Colour Screen
- Gather Auditing & Reporting Data
- Programmable Flush To Reduce Wastage
- Accurate Proportioning 1:1 up to 100:1
- Single or Multi-Colour

Binks GEMS delivers efficiency and convenience to meet real-world production schedules. Sturdy construction, quality components, ergonomic design, and powerful software make this the workhorse that will keep up with demanding projects. GEMS is operated through a large 7" touchscreen with

readily identifiable icons to provide real time information such as Flow Rate, Pot Life, Current Mix Ratio and Current Colour. Onscreen help is designed to assist operators with fault troubleshooting rather than just meaningless alarm codes.

GEMS' data capture capabilities provide insights into your daily spraying process and audit your paint resin and solvent usage. GEMS is capable of storing data for distinct production jobs, recording spraying times, colour change information and A / B material and solvent usage.

GEMS will support low pressure applications up to 5 colours and can be configured for use with 2 spray guns.

The precise dosing will always ensure a perfect paint mix and finish.



Specification	
Maximum Working Air Pressure	7 bar (105 psi)
Optimal Working Air Pressure	5.2 - 7 bar (75-105 psi)
Max Inlet Fluid Pressure	17.2 bar (250 psi)
Max Dispense Pump Flow Rate	300 or 600 cc/min
Min Dispense Pump Flow Rate	2 or 20 cc/min
"A" Side Flowmeter Range	40-1900 cc/min
Operating Temperature Range	5-50°C (41-122°F)
System Weight	59-68kg (130-150lbs)
Viscosity Range of Fluid	20-3000 cPs
Mixing Ratio Range	1:1 - 100:1
Ratio Tolerance Range	Up to +/- 1%
Wetted Parts	300 series stainless steel, PTFE, perfluoroelastomer, UHMW polyethylene
External Power Requirements	100-240 VAC, 50-60Hz. 1.4 Amp, 16 AWG power supply wire gauge
Environmental	Indoor use, pollution degree (2)

MAGIC-FLOW 2
UNIVERSAL ELECTRONIC MIXING SOLUTION



Magic-Flow 2 is a versatile and flexible mixing solution designed to accommodate many low pressure or high pressure applications. It supports a range of optional, functionality-enhancing modules to provide 2, 3 or 4K component mixing of a maximum of 29 colours with up to 4 spray guns.

- Operator Friendly 7" Colour Touch Screen
- Low or High Pressure mixing from 0.5:1 up to 50:1
- Suitable for Solvent and Water based Paints up to 29 Colours
- Programmable Recipes' & Flush Sequences
- Essential Reporting Data including VOC Calculation

Binks Magic-Flow 2 turns complicated and time consuming mixing operations into highly precise, 'select and spray' operations. It guides machine operators through daily

spraying tasks using colour icons, selectable paint recipes, pre-set flush sequences and by monitoring paint tank levels. Use Magic-Flow 2's data capturing capabilities to monitor essential information such as paint consumption, flow rates, actual mix ratios, spray times and alarm events. Collect and monitor data through the standard Ethernet interface or view report information onscreen. Ensure you remain under your VOC emissions threshold using the built-in VOC calculator. Customise Magic-Flow 2 for your solvent or water based paint application with additional modules that include robot communications, control of up to 16 agitators, remote control for in-booth operation, stack lights and Coriolis mass flow meters for non-contact measurement.

From plastic coatings to heavy corrosion protection, from manual spray applications to automated robots, Binks Magic-Flow 2 can deliver.

Specification	
Suitable for	Solvent and water based paint
Mixing Ratio range	0.5:1 – 50:1
Mixing Accuracy	Up to +/- 1%
Optimal Working Air Pressure	6 – 8 Bar
Flow Rate	50 – 2000 ml/min
Working Temperature	10 - 70°C
Pressure Range	1 – 250 Bar (1 – 450 Bar Optional)
Viscosity	20 – 100cPs
Wetted Parts	Stainless Steel, PTFE, Polyamide
Material Valves	32 max e.g. 29 Colours, 2 Solvents, 1 Hardener
Options	Multi-Gun, ATEX, Coriolis Mass Flow Meters, Robot Communications, Agitator Control, Remote Control, Printer Port, Atomising Air Switch Off

PRESSURE FEED CONTAINERS

Pressure Feed Containers

Pressure feed containers are used to allow the coating material to be prepared, thinned and conditioned, constantly agitated (if required) and then supplied in bulk to consistently maintain the correct spraying viscosity and pressure. The Binks range is equipped with easy to operate air regulators (to set the desired fluid outlet pressure), safety pressure relief valves and Manual, Rotary or Oscillating agitation types are available to provide the best quality agitation.

Binks Pressure Feed Containers are constructed from the highest grade materials and fully comply with European and Global pressure regulations including PED, ATEX and ASME.

Binks have a pressure tank to fit every industrial application.



Agitators

Binks offer a selected range of Air Driven paint agitators for general industrial use, the range includes Drum & Pail mounted agitators with Heavy Duty motors.

- Fully approved and CE marked to the latest pressure equipment directive 97/23/EC.
- Constructed from Heavy Gauge steel with forged steel clamps
- St St & Carbon Steel Plated range covers ALL industrial applications
- Higher pressure rating handles Heavier materials
- Range offers complete material handling suitability for solvent and waterborne coatings
- Inner Liners reduce cleaning time and save coating material
- Top and Bottom outlet conversion kits available
- Single air regulator as standard with optional dual outlet kits
- S & G type include filler port

Zinc Plated for Solvent-Based Coatings (10 litres)

Shown with optional twin air regulators.

4 5



Stainless Steel Wetted Parts (10 litres)

Stainless steel passageways for solvent and waterborne materials.

2 4 5



Stainless Steel Construction throughout (10, 40 and 60 litre capacity)

For waterborne and solvent based materials.

2 4 5



Galvanised Carbon Steel (40 litres)

For solvent based materials.

4 5



Bottom Outlet Kits for 183G- and 183S- ASME Code Tanks:

Bottom outlets kits include sturdy steel legs, mounting fasteners, fittings and outlet pipe.



	Bottom Outlet Kit	Fluid Outlet if using Bottom Outlet Kit
10 litre Tanks	183-3000	3/4" NPT(m) or 3/4" NPS(m)
40 & 60 litre Tanks	183-3001	3/4" NPT(m) or 3/4" NPS(m)

Note: A disposable tank liner is supplied with all pressure tanks as standard.

Replacement tank liner part numbers are:

10 litre (2.8 gal.) – PT-78-K10 or K60 40 litre (11.8 gal.) – PTL-412-K8 60 litre (19.8 gal.) PTL-415-K10



When combined with the use of disposable liners, there is no more economical way to run a paint operation for most applications.

PRESSURE FEED CONTAINERS

Pressure Feed Containers - Range and Specification

	Part No.	Capacity		Pressure Feed Tank - Construction type	Agitation	Agitator type*	Air inlet	Fluid outlet	Max. Pressure	
		Litres	US Gallon						bar	(psi)
Zinc Plated	83C-210-CE	10	2.8	Zinc plated - Carbon Steel	No Agitation	None	1/4"	3/8"	5.5	80
	83C-211-CE	10	2.8	Zinc plated - Carbon Steel	Direct Drive Rotary Agitation	D	1/4"	3/8"	5.5	80
Stainless "Wetted" Parts	83Z-210-CE	10	2.8	Stainless Steel Lid and st st fluid passages	No Agitation	None	1/4"	3/8"	5.5	80
	83Z-211-CE	10	2.8	Stainless Steel Lid and st st fluid passages	Direct Drive Rotary Agitation	D	1/4"	3/8"	5.5	80
Fully Stainless Steel	183S-210-CE	10	2.8	Fully Stainless steel - Electropolished	No Agitation	None	1/4"	3/8"	7.6	110
	183S-211-CE	10	2.8	Fully Stainless steel - Electropolished	Direct Drive Rotary Agitation	D	1/4"	3/8"	7.6	110
	183S-212-CE	10	2.8	Fully Stainless steel - Electropolished	Manual Agitation	Manual	1/4"	3/8"	7.6	110
	183S-213-CE	10	2.8	Fully Stainless steel - Electropolished	Gear Reduction Rotary Agitation	I	1/4"	3/8"	7.6	110
	183S-1010-CE	40	11.8	Fully Stainless steel - Electropolished	No Agitation	None	1/4"	3/8"	7.6	110
	183S-1012-CE	40	11.8	Fully Stainless steel - Electropolished	Manual/Option	Manual	1/4"	3/8"	7.6	110
	183S-1013-CE	40	11.8	Fully Stainless steel - Electropolished	Gear Reduction Rotary Agitation	I	1/4"	3/8"	7.6	110
Galvanised Steel	183G-1010-CE	40	11.8	Galvanised Carbon Steel	No Agitation	None	1/4"	3/8"	7.6	110
	183G-1012-CE	40	11.8	Galvanised Carbon Steel	Manual/Option	Manual	1/4"	3/8"	7.6	110
	183G-1013-CE	40	11.8	Galvanised Carbon Steel	Gear Reduction Rotary Agitation	I	1/4"	3/8"	7.6	110
Fully Stainless Steel	183S-1510-CE	60	19.8	Fully Stainless steel - Electropolished	No agitation	None	1/4"	3/8"	7.6	110
	183S-1512-CE	60	19.8	Fully Stainless steel - Electropolished	Manual Agitation	Manual	1/4"	3/8"	7.6	110
	183S-1513-CE	60	19.8	Fully Stainless steel - Electropolished	Gear Reduction Rotary Agitation	I	1/4"	3/8"	7.6	110

***Agitator types :-**

- D** Direct Drive Agitator - Air powered direct drive agitator assembly with 1/2 hp air motor and a three blade propeller to keep materials in suspension even with high solids.
- I** Indirect Air Motor Drive - Standard duty, smooth running with gear reducer, 1/2 hp, 15:1 ratio, 20 to 120 RPM. Inc throttling valve, fittings and hose for connection to air supply on tank lid. Air consumption is approx 6CFM @ 50RPM.



Agitator type D



Agitator type I

Note: Binks tanks are supplied with NPS threads as standard. For BSP threads, add a 'B' after the part no. Example: 183S-210-CE-B



Pressure Feed Containers - Accessories

Bottom outlet conversion kits #QMS-443 for 40 & 60 litre and QMS-435 for 10 litre St St tanks.

Air Regulator Kits - Pressure tanks are supplied with one air regulator as standard - Optional kits are available.

Model QMS-436: One gauge, one regulator. Converts single regulation to dual.

Model QMS-4006: One gauge, one regulator. Regulates and indicates tank pressure.

Model QMS-4007: Two gauges, two regulators. Controls tank pressure and atomisation air pressure to gun.

For further detailed pressure tank information please refer to the appropriate service bulletin.



Binks drive unit for 205 litre (55 gallon) drums

Model 31-401-1 Agitator Drive

- Air Motor Drive Unit with gear reducer
- Shipping Wt.: 9.1 kg (20 lbs)
- 1/2 HP; 15:1 Ratio; 40 RPM output
- Ref. Part Sheet 77-2804

Speed: Speed of the air motor is regulated by an air adjusting valve (part no. HAV-500). The speed of the agitator shaft below the reduction gear box should not run faster than 30 to 40 RPM maximum.



Binks indirect air motor drive for drum mounting QS-501-1-CE

- Indirect geared air motor drive, oil less design
- Fully approved to ATEX
- Up to 60 RPM
- Stainless steel material, wetted parts
- 20:1 ratio.



Part no: KB-622 Aluminium inc. hoses
Part no: KB-522-SS Stainless Steel
(no hoses)

KB11

2.3 LITRE REMOTE CUP STANDARD – ALUMINIUM & ST ST

2 4

Light weight, portable and easy to use

- 2.3 Litre capacity - greater area coverage, less refills
- Complete gun manoeuvrability at any angle
- Suitable for most Conventional or Compliant pressure/suction guns
- Stable, wide, reinforced base and fast, spin ring lid system
- **Aluminium** or **Stainless Steel** options (for waterbased materials)
- Familiar gun grip handle plus belt hook for operator convenience
- At-the-job controls with lid mounted pressure gauge
- Available complete with short cup to gun air and fluid hoses.

The KB11 is a versatile pressure fed cup designed to give complete freedom of movement for the spray gun and the operator. Suitable for use with either conventional or compliant/HVLP pressure fed spray guns the cup can handle wide variety of paints and coating materials. Its generous 2.3 litre capacity dramatically reduces the need for constant cup refills. Using a remote cup means that the spray gun is lighter and can even be used upside down with total manoeuvrability in hard to reach areas.

Air inlet and outlet connections threads	1/4" BSP(M)
Fluid outlet connection (to Spray Gun)	3/8" BSP(M)
Capacity	2.3 Litres (2 Quart)
Weight (less hoses and paint)	1.76 kg
Maximum working pressure	2 bar (30 psi)



Standard Cup Part no: 80-600
Agitated Version Part no: 80-601

STEADI-GRIP

2.3 LITRE / 2 QUART PRESSURE CUP

4 5

Light weight, portable and easy to use

- 2 Quart/2.3 litre capacity - greater area coverage, less refills
- Complete gun manoeuvrability at any angle
- Suitable for most Conventional or Compliant pressure/suction guns
- Large "wide mouth" opening enables rapid filling and easy cleaning
- Cup features four lid clamps for quick and easy access
- Comfortable gun handle shaped carrying handle and belt hook for operator convenience
- Separate air control regulator and lid mounted pressure gauge
- Anodised bright dipped Aluminium cup and "Silverstone" coating on lid interior and exterior.

The Steadi-Grip is the most advanced pressure fed cup from Binks designed to give complete freedom of movement for the Spray Gun and the operator, in particular those working on production finishing lines. Conventional or Compliant/HVLP pressure fed Spray Guns can be used with Steadi-Grip and it is suitable for use with a wide variety of paints, enamels and other coating materials. Its 2 Quart/2.3 litre capacity dramatically reduces the need for constant cup refills. Using a remote cup means that the Spray Gun is lighter and can even be used upside down with total manoeuvrability in hard to reach areas.

Air inlet and outlet connections threads	1/4" NPS(M)
Fluid outlet connection (to spray gun)	3/8" NPS(M)
Capacity	2.3 Litres (2 Quart)
Weight (less hoses and paint)	4 lbs 13 oz
Maximum working pressure	3.5 bar (50 psi)

AIR OPERATED ROTARY AGITATORS AND MIXERS

4 5

Designed for a wide variety of industrial and automotive applications. The agitators ensure paints and fluids are agitated precisely to keep paint solids in suspension and maintain optimum finishing characteristics. Binks agitators are suitable for a wide

range of viscosities and paint material types including solvent based, waterborne and many other fluids. Note: Binks recommend the use of an air oil lubricator with these air driven agitators.



Part no: 41-3312

Binks Agitators, Drives and Covers for 25 litre (5 gallon) containers

- Furnished alone or as an assembly, mounted to container covers
- Agitator and drive assembly only, standard
Speed: Speed of propeller shaft is determined by fluid, 3000 RPM maximum
Air Supply: Air supply to the motor should be 4 bar (60 psi) gauge pressure minimum

Model 41-718810

- Cover for open-top container
- Used for 25 litre (5-gallon) container
- Shipping Wt: 2.75 kg (5½ lbs)
- With inspection port and agitator hole.



Model Number	41-3312	31-133-CE
Includes	Agitator & Drive Agitator Drive	Assembly Only & Cover Assembly
Shaft/Propeller Material	Stainless Steel	Stainless Steel
Container Size	25 litre (5 Gallon) Pail	25 litre (5 Gallon) Pail
No. of Propellers or Paddles	1	1
Propeller/Paddle Diameter	79mm (3 1/8 in)	79mm (3 1/8 in)
Shaft Speed	To 3000 RPM	To 3000 RPM
Air Drive Type	Direct (HP: 1/4) (CFM:10-14)	Direct (HP: 1/4) (CFM:10-14)
Shipping Weight	6 kg (12 lbs)	16.6 kg (33 lbs)
Part Sheet Reference	77-1474	-

Binks Direct Drive Agitators for 205 litre (55 gallon) drums

4 5



Part no: QS-574-H

Part No.	Description	
QS-574-H	Rotary agitator assembly (S.S.) for 205 L. Lid mounting. shaft length 1135 mm.	Max air pressure 7 BAR
QS-575-H	Rotary agitator assembly (S.S.) for 205 L. Lid mounting. shaft length 900 mm.	Max air pressure 7 BAR
QS-576-H	Rotary agitator assembly (S.S.) for 205 L. Lid mounting. shaft length 760 mm.	Max air pressure 7 BAR

Note: Binks recommends the use of an oil lubricator with all air driven agitators.

Binks Direct Drive Agitators and Drives for open top 205 litre (55 gallon) drums

4 5



Model 41-3304 for 205 litre (55 Gallon) Drums

- Stainless Steel agitator and drive assembly only
Speed: Speed of propeller shaft is determined by fluid, 1000 RPM maximum
Air Supply: Air supply to the motor should be 4 bar (60 psi) gauge pressure minimum.

Model Number: 41-3304	
Includes	Agitator & Drive Assembly Only
Material	Stainless Steel
Container Size	205 litre (55 Gallon Drum)
No. of Propellers or Paddles	2
Propeller/Paddle Diameter	130 mm (5 1/8 in) (SS)
Shaft Speed	To 1000 RPM
Air Drive	Type: Direct / HP: 1/4 / CFM:10-14
Shipping Weight	6 kg (12 lbs)
Part Sheet Reference	77-1390

Hand Held Quick Mixers

For 25/50L and 200L containers.

4 5



Part no: 149-873

Part No.	Description
149-873	Variable speed, 1 propeller, 127 mm diameter, shaft and propeller SS (shaft length 533 mm)
149-874	Variable speed, 1 propeller, 127 mm diameter, shaft and propeller SS (shaft length 1,016 mm)

Note: These quick mixers are suitable for non ATEX areas only.

AIR OPERATED ROTARY AGITATORS, MIXERS AND ELEVATORS 4 5

Binks Gear Drive Agitator for heavy fluids in open top 205 litre (55 gallon) drums



Model 31-397 Gear Drive Agitator (with cover)

- For open top 205 litre (55) gallon drums
- Gear drive, 40 RPM
- For heavier fluids such as paints and mastics furnished with:
- 1/2 HP air motor (10 to 14 CFM)
- Zinc Plated Clear Chromate cover (31-124)
- Two 370mm (14 1/2 in. diameter Stainless Steel paddles with Stainless Steel shaft

Speed: Speed of the air motor is regulated by an air adjusting valve (part no. HAV-500). The speed of the agitator shaft below the reduction gear box should not run faster than 30 to 40 RPM maximum.

Air Supply: Air used to operate this unit should come directly from a high pressure source; do not use air that has passed through a regulator. Air supply to the motor should be a minimum of 4 bar (60 psi) gauge pressure.

Container Size	205 litre (55 Gallon) Drum
Motor Specifications	Air Motor Model: Gear / HP: 1/2 / CFM: 10-14
Shaft Specifications	Mount: Flange / Diameter: 12.7 mm (1/2 in) / Speed: 30 to 40 RPM
Propeller Specifications	Number of Props: 2 / Diameter: 370 mm (14.5 in) / Material: Stainless Steel
Cover Specifications	Model Number: 31-124 / Size: 205 litre (55 Gallon) Drum Material: Zinc Plated Clear Chromate Cover

Note: Refer to the Agitator Service Bulletin for specific application details.

Electrically Driven Paint Agitator

The electrically driven agitators provide sufficient torque to drive paddle assemblies for the agitation of the modern Solventborne and Waterborne paints used in today's automotive industry. A range of paddle sizes and shaft lengths are available to accommodate the different diameters and heights of available paint tanks.

- AC Inverter control option
- Variable speed range
- Integral Shaft Seal
- Incorporation of Tank Lid Seal
- Integral flinger and drain pocket to prevent possibility of gearbox oil contamination.

Specification

Part Number	106946 AC Inverter
Paddle Speed range	47 – 190 rpm
Electric Motor	400v – 3ph – 50Hz 0.37kW Motor Eexd II 2 G T4 IP66 Atex
Shaft Seal	PTFE
Mounting Boss	Ø160 with 4 – holes Ø9 on 140 PCD

Pneumatic Elevators 4 5

The new Binks elevators are driven by an easy to operate pneumatic actuator, enabling the changing of drums with a minimum of inconvenience. Both models feature an anti-twist mechanism, sturdy construction and are designed for use with both solvent-based and waterborne materials.

- Simple compressed air operation
- Speed control possible in both directions
- Elevator can be set at any height within its stroke and will not drop from that point
- ATEX approved & marked for use in Zones 1 and 2

Specification

Part Number	Binks 25L Elevator 104153	Binks 205L Elevator 104112
Max working air pressure	7 Bar (101 psi)	7 Bar (101 psi)
Air Inlet	1/4" BSP female	1/4" BSP female
Stroke	500mm / 19.7"	955mm / 37.6"
Maximum Drum Size	Ø340mm	Ø640mm
Unit height (fully extended)	1380mm / 54"	2270mm / 89"
Weight	45.5Kg / 100lbs	64Kg / 140lbs



BINKS FLUID REGULATORS

2 4



Part no: HGBR-609

A complete range for all applications.

- Highly accurate pressure settings with no pressure “creep”
- Minimum setting pressure below 0.25 bar (3.75 psi)
- Regulator body design reduces paint wastage during maintenance
- Fast disassembly and cleaning
- Fluid passages in 303 Stainless Steel as standard
- Compatible with solvent and waterborne paints and materials
- Manual or Automatic control
- Consistent fluid pressures maintained without fluctuation.

Designed and developed for use in the latest high-tech paint shops our range of Diaphragm Fluid Pressure Regulators are precision made to provide extreme accuracy of the fluid as it arrives at the Spray Gun and/or Applicator. The Binks fluid regulators with either manual or automatic control can be utilised with Diaphragm Pumps, Pressure Feed Tanks or any size of Paint Circulating System.

Note: For ceramic applications contact Finishing Brands

Type Model	Specification							
	Part number	Manual adjustment	Automatic Pneumatic adjustment	Inlet pressure mini/maxi bar (psi)	Outlet pressure mini/maxi bar (psi)	Fluid Flow maximum l/min	Fluid Inlet fitting	Fluid Outlet fitting
In line Regulator	HGB-509-5-R38 (no gauge)	■		2 (29)/12.5 (181)	1 (14)/5 (72)	13	3/8 NPS	3/8 NPS
with gauge 1.2 Bar	HGB-609-1.2-R38	■		1 (14)/8 (116)	0.15 (2)/1.2 (17)	8.3	3/8 NPS	3/8 NPS
with gauge 5 Bar	HGB-609-5-R38	■		2 (29)/12.5 (181)	1 (14)/5 (72)	13	3/8 NPS	3/8 NPS
with gauge 9 Bar	HGB-609-9-R38	■		3/15 (217)	3 (43)/9 (130)	13	3/8 NPS	3/8 NPS
	HGB-510-R1		■	2 (29)/15 (217)	0.5 (7)/15 (217)	1.6	F 1/4 BSP	F 1/4 BSP
	HGB-510-R2		■	1 (14)/15 (217)	0.15 (2)/7	13	F 1/4 BSP	F 1/4 BSP
	HGB-510-R4		■	1 (14)/15 (217)	0.15 (2)/4	6.8	F 1/4 BSP	F 1/4 BSP
	84-598		■	2 (29)/15 (217)	0.5 (7)/15 (217)			
Gun Mounted Regulator	HGS-5132		■	3.5 (50)/20 (290)	0.14 (2)/7 (101)	2.5	1/8 NPT	3/8 NPS
	HGS-5112		■	3.5 (50)/20 (290)	0.14 (2)/7 (101)	2.5	1/4 NPS	3/8 NPS
	HGS-5211	■		3.5 (50)/20 (290)	0.14 (2)/7 (101)	2.5	1/4 NPS	Bayonet
	HGS-5222	■		3.5 (50)/20 (290)	0.14 (2)/7 (101)	2.5	3/8 NPS	3/8 NPS
	HGS-5212	■		3.5 (50)/20 (290)	0.14 (2)/7 (101)	2.5	1/4 NPS	3/8 NPS
Back Pressure Valves	84-404	■		0.7 (10)/9.8 (142)	0.7 (10)/9.8 (142)	42	3/4 NPT (F)	3/4 NPT (F)
	HGBR-609	■		2 (29)/12.5 (181)	0.9 (130)	18	1/4 NPS/BSP	1/4 NPS/BSP
	84-601	■		9 (130)		3.8	1/2 NPT	1/2 NPT
HP in line regulator	84-420	■		206 (2987)	20.6 (298)/137.8 (1998)	3.8	1/4 NPT	1/4 NPT



Part no: HGS-5222



Part no: 84-404



Part no: HGB-510-R1



Part no: 84-420



Part no: HGB-509-5-R38

AIR FILTER REGULATORS

DVFR Advanced Air Management

- Genuinely high air flows for Conventional and Compliant/Trans-Tech Spray Guns
- Rolling diaphragm for rapid response and precision control
- Optional filter specifications for spraying and air fed respiratory protection outfits
- Tough, heavy duty construction for long service life
- Multi-valved outlets for Spray Gun, Air Fed Mask and Air Tools plus semi-automatic filter drains
- Tamper proof, removable and lockable adjustment knobs.

Compressed air is the lifeblood of every spray shop and it's effective management is vital to operator safety, efficiency and maintaining ultimate finish quality. The DeVilbiss DVFR range of air filter regulators and coalescers are manufactured using super resistant techno-polymer materials used in the construction of the filter bodies ensuring total solvent resistance, while the state of the art rolling diaphragm technology ensures optimum air flow and precision control.



Part no: DVFR-1



Part no: DVFR-2

DVFR-1 Filter Regulator

This high capacity, 124 cfm, three outlet unit has been designed for use in and around the Spray Booth. Constructed using leading edge techno-polymer materials, the DVFR-1 is resistant to solvents. Dual filtration eliminates dirt down to 5 microns from reaching the Spray Guns and like all DVFR filter regulators, condensate can be removed from the filter bowl manually or semi-automatically on depressurisation of the system.

DVFR-2 Filter Regulator Coalescer

- Ideal for operator 'breathing' air

The industry favourite is ideal for both industrial and heated "combi booths" Spray Booths, it is mandatory for use with Air Fed Respiratory Protection.

Triple filtration removes dirt and other contaminants down to 0.01 microns, while the capacity of 124 cfm provides sufficient air flow to run two masks and two guns.



Part no: DVFR-3

DVFR-3 Filter Regulator Coalescer

This general purpose unit has been developed for both paintshop and general workshop applications. The Dual filtration process eliminates dirt down to a particle size of 20 microns from air tools and Spray Guns, while the two ball valve controlled outlets have a total capacity of 60 cfm.

DVFR-4 Filter Regulator Coalescer

This unit is designed for use with spray equipment, which requires filtered air at main line pressure, while the other outlet pressures can be regulated.

The unit has a generous capacity of 90 cfm and dual filtration down to a particle size of 5 microns.

Note: This unit is not suitable for use in a low bake spray booth.



Part no: DVFR-4

Replacement Filter elements

In order to maintain optimum air quality, which is of vital importance when Air Fed Respiratory Equipment is being used, filters must be changed regularly. Three types of replacement filter element are available for particle sizes of 20, 5 and 0.01 microns.

Part no's	
DV-9451705	Replacement 5 micron filter element for DVFR-1, DVFR-2 and DVFR-4
DV-9451711	Replacement 0.01 micron fine filter breathing element air for DVFR-2
DV-9351706	Replacement 20 micron filter element for DVFR-3



AIR FILTER REGULATORS

Model – DVFR Range	DVFR-1	DVFR-2*	DVFR-3	DVFR-4
Air Inlet Thread	1/2" BSP (F)	1/2" BSP (F)	1/2" BSP (F)	1/2" BSP (F)
Regulated Outlets	3 Valved	3 Valved	2 Valved	2 Valved + 1 Plugged
Unregulated Outlets	NA	NA	NA	1 Valved + 1 Plugged
Air Outlets (Ball Valves)	1/4" BSP (M)	1/4" BSP (M)	1/4" BSP (M)	1/4" BSP (M)
Width (Overall)	175 mm (6.9")	240 mm (9.5")	165 mm (6.5")	290mm (11.5")
Height (Overall)	280 mm (11")	280 mm (11")	240 mm (9.5")	280 mm (11")
Weight	2500 gms (88 oz)	3200 gms (113 oz)	1341 gms (46 oz)	2950 gms (104 oz)
Capacity (Maximum Air Flow)	3500 l/min (124 cfm)	3500 l/min (124 cfm)	1698 l/min (60 cfm)	2550 l/min (90 cfm)
Maximum Air Inlet Pressure	13 bar (189 psi)	13 bar (189 psi)	13 bar (189 psi)	13 bar (189 psi)
Maximum Regulated Outlet Pressure	0-8 bar (0-116 psi)	0-8 bar (0-116 psi)	0-8 bar (0-116 psi)	0-8 bar (0-116 psi)
Maximum Operating Temperature	100°C (212°F)	100°C (212°F)	40°C (104°F)	40°C (104°F)
Pressure Gauge	0-11 bar (0-160 psi)	0-11 bar (0-160 psi)	0-11 bar (0-160 psi)	0-11 bar (0-160 psi)
Gauge Port	1/8" BSP (F)	1/8" BSP (F)	1/8" BSP (F)	1/8" BSP (F)
Air Filtration	Down to 5 microns	Down to 0.01 microns*	Down to 20 microns	Down to 5 microns
Drain Valve	Semi-Automatic	Semi-Automatic	Semi-Automatic	Semi-Automatic
Maximum Pressure Drop	5% of Inlet Pressure	10% of Inlet Pressure	5% of Inlet Pressure	5% of Inlet Pressure

*Suitable for Breathing Air

FINISH LINE AIR FILTER REGULATORS & COALESCERS

4 5



Part no: FLFR-1

FLFR-1 Filter Regulator

- Air filtration down to 20 microns
- High quality manufacture
- Air flow of 70cfm (at 7 bar – 100 psi inlet pressure)
- Lockable and removeable (tamperproof) control

FLCF-1 Coalescing Filter

- A 3/8" (port size) coalescing (fine oil) filter
- Air filtration down to 0.01 microns (suitable for breathing Air-Fed Visors/Masks)
- Replaceable filter element
- Maximum working pressure 18 bar (260 psi)



Part no: FLCF-1

FLRC-1 Filter Regulator Coalescer

- Compact, low cost single operator Filter Regulator and Coalescer
- Filtration down to 0.01 microns suitable for Air Mask or Visor
- Not suitable for low bake temperatures

FLRCAC-1 Filter Regulator Coalescer with Activated Carbon Filter

- High efficiency filter designed to remove dirt, liquid oil and water from spraying and breathing air
- Filtration down to 0.01 microns plus activated carbon filter removing contaminants down to 0.003ppm



Part no: FLRC-1

Regulator Assemblies

Part No.	Description
FLFR-1	Single outlet filter regulator (70 cfm)
FLCF-1	Coalescing (fine oil) filter (25 cfm)
FLRC-1	Single outlet filter regulator coalescer
FLRCAC-1	Single outlet filter regulator with coalescer with activated carbon filter
9450102	Replacement filter element
XA-12	Replacement coalescing filter element
AC-12	Replacement activated carbon filter
9450802	Upper cover
9450301	Metal bowl
GA-319	Gauge



Part no: FLRCAC-1

AIR AND FLUID HOSES AND CONNECTORS (LOW PRESSURE)

4 5



Purpose made hoses and connectors for the spray industry with conductive outer cover.

Binks, DeVilbiss and Ransburg hoses and connectors are purpose made for the spray finishing industry. The use of the best and most dependable air and fluid hoses are vital to all finishing facilities to maintain optimum production levels with the minimum of maintenance downtime. By choosing Binks, DeVilbiss and Ransburg hoses and connectors you are assuring that your spray application equipment receives air and fluids in the best possible condition at the specified pressures and volumes. Binks, DeVilbiss and Ransburg hoses and connectors are manufactured to the highest quality to maintain engineering tolerances for maximum performance, durability and working life.

- Suitable for all low pressure finishing applications
- Approved for most spray fluids
- Hoses include a conductive outer cover to comply with European ATEX & CE legislation
- Smooth outer cover ensures easy cleaning
- Flexible and manoeuvrable for decreased operator fatigue
- Hoses have excellent chemical compatibility
- Three piece reusable hose connectors (brass plated)
- Air & Fluid hose available per metre or delivered on 150m hose reels.
- Wide range of BSP & NPS threaded connectors.



150m hose reels are available.

Choose hoses and connector part numbers from this specification chart:

Hose Pt No.	Description	Type	Bore size mm	Hose cover	Inner bore	Conductive	ATEX/CE	Max Working Pressure
H-7501	5/16" Bore AIR HOSE Red rubber	AIR	8	EPDM	EPDM	✓	✓	17 bar (250 psi)
H-7502	3/8" Bore AIR HOSE Red Rubber	AIR	9.5	EPDM	EPDM	✓	✓	17 bar (250 psi)
H-7503	1/4" Bore FLUID HOSE Black	FLUID	6	Nitrile	Nylon	✓	✓	34 bar (500 psi)
H-7504	3/8" Bore FLUID HOSE Black	FLUID	9.5	Nitrile	Nylon	✓	✓	34 bar (500 psi)
H-7501-150M	5/16" Bore Air Red Rubber (150M reel)	AIR (BULK)	8	EPDM	EPDM	✓	✓	17 bar (250 psi)
H-7502-150M	3/8" Bore Air Red Rubber (150M reel)	AIR (BULK)	9.5	EPDM	EPDM	✓	✓	17 bar (250 psi)
H-7503-150M	1/4" Bore Fluid Black (150M reel)	FLUID (BULK)	6	Nitrile	Nylon	✓	✓	34 bar (500 psi)
H-7504-150M	3/8" Bore Fluid Black (150M reel)	FLUID (BULK)	9.5	Nitrile	Nylon	✓	✓	34 bar (500 psi)

EPDM is (Ethylene Propylene Diene Monomer) rubber

3 piece Re-usable Connections

Part no.	Bore	Connector
PA-HC-4523	1/4" (6 mm)	1/4" BSP
PA-HC-4527	5/16" (8 mm)	1/4" BSP
PA-HC-4528	3/8" (9.5 mm)	1/4" BSP
PA-HC-4543	1/4" (6 mm)	3/8" BSP
PA-HC-4548	3/8" (9.5 mm)	3/8" BSP
P-HC-4523	1/4" (6 mm)	1/4" NPS
P-HC-4527	5/16" (8 mm)	1/4" NPS
P-HC-4528	3/8" (9.5 mm)	3/8" NPS
P-HC-4543	1/4" (6 mm)	3/8" NPS
P-HC-4548	3/8" (9.5 mm)	3/8" NPS

High Pressure Hose Assemblies (Airless)

Hose connectors: 1/4" NPS			
Length	Bore	Pressure max.	Part no.
1m	3/16"	350 bar	H-5811
7.5m	3/16"	350 bar	H-5813
7.5m	1/4"	310 bar	H-5818



The above connectors are three piece re-usable (Plated brass)

QUICK DETACH FITTINGS

4



DeVilbiss Part no's (air)	
MPV-5	Male Quick detach stem with 1/4" female fitting (fits Spray Gun inlets)
MPV-424	Female quick detach connection with 1/4" male fitting (fits hose ends)
MPV-10	Male quick detach stem with 1/4" female fitting
MPV-462	Female quick detach with 1/4" female fitting (fits filter regulator valves)
MPV-463	Economy pack includes 1 of each of the 4 shown above
DeVilbiss Part no's (fluid)	
PA-HC-4482	Quick detach system - 3/8" BSP - Fluid
QDL-4808	QD Connection - Fluid
SSQD-6B-316	QD Connection SR 3/8" Male
SS-STEM-6B-316	QD Stem 3/8" Female
Binks Part no's (fluid)	
19 07 61	QD body assembly (hose end)
20 11 20	QD stem assembly (gun end) Stainless Steel

Purpose made for a long and reliable life cycle

- Total convenience for air and fluid, quick detach reliable self-sealing
- High flow air connections - minimum pressure drop
- Ideal for all types of Spray Guns, Conventional, Compliant and HVLP
- Use them on Respirators, Hoses and Filter Regulators
- Four types available separately or in a set
- Fluid QDs made from Stainless Steel.

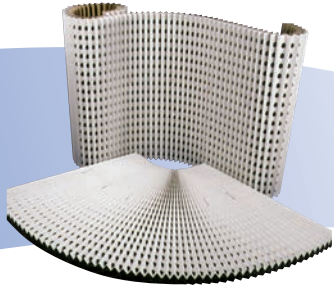

Standard Filter Paper

BINKS DISPOSABLE STANDARD SPRAYBOOTH FILTER PAPER

4 5

- Up to 98% filtration efficiency
- Outlasts other filters three to five times
- High loading capacity - longer working life - low pressure drop
- Expansion strapping ensures correct spacing of filter corrugations
- Filter marked at every foot for ease of cutting
- Concertina design reduces storage and transportation costs
- "Four face filtration"
- Bright white spray face - improves spraybooth lighting conditions.
- Stapled construction for strength and longer life
- Made at the Binks factory in Scotland

Binks disposable paper filter consists of 2 sheets of heavy cardboard paper formed into double accordion type folds with staggered holes to provide a highly efficient filter. Paint laden air is drawn into the filter by the Spray Booth fan and is forced to change direction four times causing particulate to adhere to the surfaces of the filter before exhausting to atmosphere. The large air openings in the filter allow high volumes of air to be exhausted without loss of efficiency as the media 'loads', resulting in a much longer life than other filter systems.

Standard Filter Paper Technical Specification	
Filter Construction	Self supporting, two ply high strength cardboard paper. Bright white finish.
Air Flow Rates	100-200 feet per minute (0.5 - 1.0 metres per second) Normal 140 fpm (0.7 ms)
Pressure Differential	Initial @ 0.75 M/S = 30 PA (0.12" SWG) MAXIMUM 130-250 PA (0.52"-1.0" SWG)
Temperature Range	MAXIMUM 180°C (356°F)
Expansion Limiter	Expansion limiting straps ensure correct pleat guaranteeing optimum density of 8 corrugations per running foot (30.4cm)

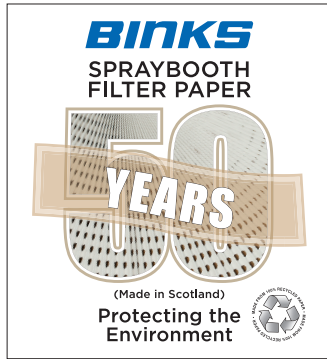

Part no: 20 72 29	
Surface Area	10 sq yds
Filter Size Per Box	H90 x L924cm (H36" x L30ft)
Weight Per Box	10.5 kg (23lbs)

Part no: 20 79 00	
Surface Area	10 sq mtrs
Filter Size Per Box	H75 x L1346cm (H30" x L44ft)
Weight Per Box	12.6kg (28lbs)

Part no: 20 79 01	
Surface Area	10 sq mtrs
Filter Size Per Box	H90 x L1115cm (H36" x L36ft)
Weight Per Box	12.6kg (28lbs)

Part no: 20 79 02	
Surface Area	10 sq mtrs
Filter Size Per Box	H100 x L1038cm (H39" x L34ft)
Weight Per Box	12.6kg (28lbs)

SPRAY BOOTH FILTER PAPER

BINKS ECO SPRAYBOOTH FILTER PAPER

4 5

2 layers of bright white paper, punched, pleated, fitted with expansion straps, then stapled together. For superior strength and longer working life.

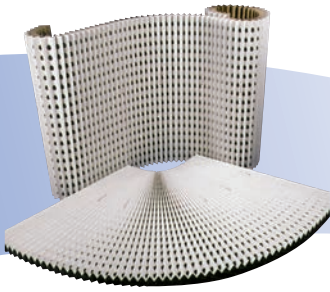

ECO Filter Paper

Part No	Description	Surface Area	Filter Size Imperial	Filter Size Metric (cms)
207229EF	Eco Filter	10 sq yds	H 36" x L 30'	H 90 x L 924
207900EF	Eco Filter	10 sq mtrs	H 30" x L 44'	H 75 x L 1346
207901EF	Eco Filter	10 sq mtrs	H 36" x L 36'	H 90 x L 1115
207902EF	Eco Filter	10 sq mtrs	H 39" x L 34'	H 100 x L 1038

ECO Filter Paper Technical Specification	
Filter Construction	Self supporting, two ply high strength cardboard paper. Bright white finish.
Air Flow Rates	100-200 feet per minute (0.5 - 1.0 metres per second) Normal 140 fpm (0.7 ms)
Pressure Differential	Initial @ 0.75 M/S = 30 PA (0.12" SWG) MAXIMUM 130-250 PA (0.52"-1.0" SWG)
Temperature Range	MAXIMUM 180°C (356°F)
Expansion Limiter	Expansion limiting straps ensure correct pleat guaranteeing optimum density of 8 corrugations per running foot (30.4cm)

BINKS SUPER FILTER – SUPER EFFICIENCY SPRAY BOOTH FILTER PAPER

4 5

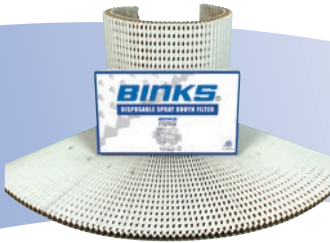

SUPER Filter Paper

- Super Filter – Outlasts other filters
- Four Face Filter Technique PLUS additional “Final Stage” polyester filter
- Superior Construction – Glued and Stapled
- Over 99% filtration efficiency
- High Loading Capacity – Longer Working Life – Low pressure drop
- Fits ALL types of dry filter Spray Booths
- Expansion strapping – Ensures correct spacing of filter corrugations
- Moisture resistant and Self Supporting
- Concertina design – Reduces storage and transportation costs.

Binks Super Filter is constructed from two sheets of heavy duty cardboard paper and formed into double “accordion” type folds, stapled, glued and backed with a high efficiency polyester media, which dramatically increases the filter efficiency and “loading capacity”.

Super Efficiency Filter Paper Technical Specification	
Filter Construction	Self supporting, 2 ply high strength cardboard paper. Bright white finish
Air Flow Rates	0.5-1.0 metres per second (100-200 feet per minute) Normal 0.7 m/s (140 FPM)
Pressure Differential	Initial @ 0.75 m/s = 30 Pa (0.12" SWG) Maximum 130-250 Pa (0.52"-1.0" SWG)
Temperature Range	MAXIMUM 100° C
Expansion Limiter	Expansion limiting straps ensure correct pleat
(Guarantees optimum performance)	Density of 8 corrugations per running foot (30.4 cm)

Part no: 20 72 29 SE	
Surface Area	5.4 sq mtrs
Filter Size Per Box	H90 x L600 cm
Weight Per Box	8.05 kg (inc. box)

Part no: 20 79 02 SEF	
Surface Area	8 sq mtrs
Filter Size Per Box	H100 x L800 cm
Weight Per Box	10.26 kg (inc. box)





Part no: PROV-600 Air fed visor outfit

DEVILBISS PRO VISOR

AIR FED RESPIRATOR

- Purpose designed to provide best possible protection for all kinds of spray painting applications
- The most comfortable and lightweight air fed visor outfit
- Fully adjustable head band for best operator comfort
- Removable peak reduces spray booth light glare
- Lightweight, Ergonomic waist belt design allows right or left side use
- Wider peripheral view for excellent visibility
- Audible warning device – alerts operator to low air pressure.

The DeVilbiss Pro Visor air fed respiratory protection system has been purpose designed for use by sprayers.

The technically advanced design provides the perfect combination of safety and comfort in the spray booth, with excellent freedom of movement.

The Pro Visor disperses breathing air gently around the lightweight visor at a positive pressure with no misting or discomfort, ensuring every sprayer can work at their best. The wrap around visor provides excellent and much wider peripheral vision, whilst the removable peak reduces glare from spray booth lighting. There is also plenty of space inside the helmet for sprayers who wear spectacles.

Replaceable clear visor covers are available in packs of 10 or 50.

Specifications

Protection	APF = 40 / NPF = 200
Carbon Filter Life	Approx 3 months
Supply Pressure	4.0 bar (60 psi) minimum to 7.0 bar (100 psi) maximum
Air Flow Rate	128 – 160 l/min (4.5 – 5.7 SCFM)
Noise level @ 160 l/min	69.7 db
Approvals	BSi & complies to CE PPE directive 89/686/EEC. Conforms to EN 14594:2005 Class 3A
Zone Classifications	Suitable for use in Zones 1 and 2 / gas groups IIA and IIB, Cert: SR0136



Part no: MPV-627 Complete face visor outfit

DEVILBISS MPV-627

AIR FED HALF-MASK BREATHING OUTFIT

- A single air line supplies breathing and spraying air
- One piece high specification goggles are included
- The facepiece incorporates dual exhalation valves and an air inter diffuser
- Waistbelt incorporates odour filter and pre-set visor air regulator
- Outfit includes high quality gun hose (1.2M x 8mm bore).

The MPV Air-Fed Half-Mask outfit remains a firm favourite with a large number of professional sprayers. The mask has a softer, more pliable face piece with a user-friendly headstrap cradle.



Part no: MPV-629 Valuair Half Mask Respirator

DEVILBISS MPV-629

HALF-MASK RESPIRATOR

- Lightweight, soft, pliable face piece
- Easy bayonet fitting filter cartridges
- Comfortable elasticated /moulded head strap cradle
- Replaceable A2 specification cartridges supplied as standard
- Pre-filters to extend the service life of the main filter cartridges

Specification – A2 Filters

A2 filters are for use against organic vapours with boiling points above 650°C. The Valuair mask with A2 filter cartridges can therefore be used in areas of contamination up to 10 x the Occupational Exposure levels set by the Health and Safety Executive. Suitable for use with cellulose paints, primers, lacquers and varnishes but not suitable for use with Isocyanates. Assigned Protection Factor of 10.

Specification

Part no	Description
MPV-629	Valuair Cartridge Mask complete with A2 Filter cartridges and pre-filters
MPV-492	Pair of pre-filter covers plus ten filter pads
MPV-494-K2	Pack of two A2 specification filter cartridges
MPV-4006	One piece protective goggles for use with half masks



Part no: MPV-496 and MPV-497
Freedom Half Mask.

DEVILBISS MPV-496
HALF-MASK RESPIRATOR

4 5

- Lightweight, dual filter, semi-disposable Half Mask Respirator
- Can be used up to a maximum of 28 days
- Maintenance free and requires no spare parts
- Low nose bridge helps to accommodate goggles for optimum vision and safety
- Head strap has no buckles or fasteners and is comfortable and easy to use

Specification – A2 Filters

A2 filters are for use against organic vapours with boiling points above 650° C. The Freedom mask with A2 filter cartridges can therefore be used in areas of contamination up to 10 x the Occupational Exposure levels set by the Health and Safety Executive. Suitable for use with cellulose paints, primers, lacquers and varnishes but not suitable for use with Isocyanates. Assigned Protection Factor of 10.

Part no	Description
MPV-496	Freedom Cartridge Mask complete with A2 Filter cartridges
MPV-4006	One piece protective goggles for use with half masks

DEVILBISS GUN MOUNTED PAINT FILTERS

2 4



Part no: VSA-512 3/8" BSP Fluid Filter Assembly (Excludes gun)

- Prevents paint inclusions in the sprayed finish
- Superior Stainless Steel construction
- Suitable for solvent and waterborne paints and materials
- Competitive list price
- Includes THREE filter elements as standard (60, 112 and 280 micron)
- Universal female thread – fits onto all 3/8" threaded guns
- Accepts USA and French style filter elements.

The paint filter assembly has been specifically designed for use with all types of low pressure spray painting

equipment and comes complete with a range of three styrene filter inserts as standard. The VSA-512 is manufactured from high grade Stainless Steel with "universal" 3/8" threads for easy use on both BSP and NPS threaded spray guns.

Part Number VSA-512

St St Gun mounted paint filter kit includes one of each filter screen (Green/Blue & White)

Gun Mounted Replacement Filters:-

VSA-3	Spare 60 Micron Green filter (.0024")
VSA-4	Spare 112 Micron Blue filter (.0046")
VSA-5	Spare 280 Micron White filter (.0125")

GRAVITY AND SUCTION CUPS AND SPARES

4 5



Gravity Feed Cups

Part No	Description
GFC-501	568ml (1 Pint) Acetal gravity cup for Advance/GTI/GFG
KGP-509-1	284ml (1/2 Pint) Nylon gravity cup for GFG (HD)
SRI-510	125ml Acetal gravity cup
SRI-42-K3	Pack of 3 cone filters
SRI-478-K12	Pack of 12, 125ml gravity cups for SRI (HD)
GFC-402	Lid assembly for GFC-501 gravity cup
KGP-401	Lid assembly for KGP-509 gravity cup
GFC-17-K5	Washer
GFC-2-K5	Pack of 5 drip check lids
KGP-5-K5	Pack of 5 gravity cup strainers for GFC-501 & KGP-509
SRI-8-K6	Pack of 6 lids for SRI gravity cups (HD)

Suction Feed Cups

Part No	Description
KR-566-1-B	1 litre Suction Cup complete
KR-4001-B	Cup Lid Assembly
KR-11-K3	Lid Gasket - Kit of 3
KR-115-K5	Drip Free Diaphragm - Kit of 5
KR-483-K10	Kit of 10 mesh KR cup strainers – to fit 7/16" tube, 115 Micron
KR-484-K10	Kit of 10 mesh KR cup strainers – to fit 7/16" tube, 350 Micron
KR-110-K3	Kit of 3 Spot Pots

DEKUPS DISPOSABLE CUP SYSTEM

4



The lightweight cup liner collapses easily providing a consistent paint flow with minimal paint wastage.

DPC-601 DeKups kit contains 32 disposable lids and liners. Note: The kit does not include disc, stick filters or plugs. For more info and accessories see the price list.

Part no: DPC-601



DRIP-FREE DIAPHRAGMS

4 5



Part no: KR-115-K5 (Pack of 5)

Prevents suction cup leaks and vent hole blockage.

- Allows the cup to be used at angles without fear of leakage
- Fits snugly under the cup lid - no need to remove the gasket
- Shallow wedge shape flows paint away from the vent hole
- Keeps a suction gun working smoothly.

SPRAY GUN OIL

4 5



Part no: GL-1-K10 Kit of 10 sachets of spray gun oil

Daily lubrication ensures a gun's long service life.

- Keep your Spray Gun in A1 working order
- A silicone-free lubricant has no affect to quality finishes
- Small, handy sachets to keep in the spares box.

SUCTION CUP FILTERS

4



Convenient, easy fit suction cup paint filters.

- Effectively removes dirt, flakes and scum
- Keeps the Spray Gun passages clear
- Inexpensive and virtually indestructible
- Resistant to most solvents easily cleaned
- Pushes onto the fluid tube of KR suction cups.

Part no: KR-484 51 mesh filter screen (general purpose)
KR-483 130 mesh filter screen (finer filtration)

GUN CLEANING BRUSHES

4 5



Ideal for a variety of gun cleaning jobs.

- Tough, resilient bristles for useful service
- Correct size for cleaning most parts of the gun
- Ring ended for hook storage.

Part no: 4900-5-1-K3 Pack of 3 brushes

BINKS DISPOSABLE PRESSURE TANK LINERS

4 5



- Enable quick colour changes
- Reduce solvent costs
- Reduce clean-up time
- Solve disposal problems
- Will not contaminate material

Custom made of tough, durable high-density Polyethylene for maximum performance. Includes Anti-Static additive to minimise static electricity build-up from the friction of shipping and handling liners.

When combined with the use of disposable liners, there is no more economical way to run a paint operation for most applications.

Replacement tank liner part numbers are:	
10 litre (2.8 gal.)	PT-78-K10 (10 pack) or K60 (60 pack)
40 litre (11.8 gal.)	PTL-412-K8 (8 pack)
60 litre (19.8 gal.)	PTL-415-K10 (10 pack)

ACCESSORIES

DEVILBISS "UNI" SWIVEL FITTING (LOW PRESSURE)

4 5



- Fits DeVilbiss/Binks and most other guns
- Reduces the risk of RSi
- Operator friendly - reduced "hose drag"
- Swivels and angles the Spray Guns

Part no: MPV-60 or MPV-60-K3 (pack of 3)

Avoiding repetitive strain injuries (RSi) is becoming more and more important in workshops and modern bodyshops. Whilst reducing the weight of spray guns and air tools has been a major help, DeVilbiss have introduced another way forward in combating the problem.

This simple, practical accessory really helps to ease the weight of the hose and reduce fatigue when spraying. It angles as well as rotates so reducing hose drag and pull on the Spray Gun handle. It comes with a male quick-detach stem fitting to give instant, spannerless air hose fitting and has a 1/4" thread for gun or air tool attachment.

AIR BLOW GUN

4 5



Harness your compressed air for clean-up's.

- Lightweight
- Durable design
- Fitted with safety diffuser
- Low noise factor
- Lightweight.

Part no: DGD-505-E

MIXING CUPS

4 5



Easy-to-use, disposable mixing cups.

- Handy, disposable, easy stacking mixing cups
- Made from solvent resistant clear polypropylene
- Permanently marked with 2:1, 3:1 and 4:1 mix ratios
- Calibrated with a 0-600 volumetric measurement scale.

Part no: MC-1-K50 Pack of 50 cups

VS-522 FLUID STRAINER

4



Complete with 150 micron filter element as standard, for use with pressure tanks and low pressure diaphragm pump systems.

- Fits directly onto the Pressure Tank or Pump outlet
- Improves quality of paint finish by removing unwanted particles etc
- Brass/Nickel plated construction with nut and tail piece (3/8") for easy connection.

Part no: VS-522
Part no: VS-55 for replacement 150 micron nylon conical filter element.

IN-LINE AIR ADJUSTING VALVE

4 5



Lightweight, at the gun pressure adjustment.

- Fits neatly in-line at the gun air inlet
- Ideal for setting up Compliant and HVLP Spray Guns
- Increase or decrease working pressure at-the-gun
- Loose swivel nut for convenient positioning
- Lightweight design (only 50 gms) does not affect balance
- 40mm diameter gauge in PSI and Bar
- Calibrated up to 11 Bar (160 PSI).

Part no: HAV-501

PROFESSIONAL SPRAY GUN CLEANING KIT

4 5



- Multi-purpose professional kit suitable for all Spray Guns
- Comprehensive range of brushes and tools
- Can be easily hung in the gun cleaning area
- Includes cleaning instructions and Spray Gun oil.

Part no: KK 4584

VISCOSITY CUPS

4



The fast, simple way to check out paint viscosity.

- Tough, durable, easy to clean Nylon
- Precision metal drain out insert
- Hanging hook for convenient storage
- No. 4 Ford Cup.

Part no:7000-114-K2
Pack of 2 viscosity cups

SPOT POTS

4 5



- 0.5 litre capacity Nylon cup insert cuts down on costly paint mixes
- Tapered base ensures that minimal quantities of paint can be utilised
- Quickly and easily cleaned for frequent colour changes
- Fits all 1 litre capacity KR type suction cups.

Part no: KR-110-K3

GRAVITY CUP FILTERS

4



Convenient, easy fit gravity cup paint filters.

- Eliminate the risk - fit a filter
- Fits snugly in the neck of the gravity feed cup
- Effectively removes dirt, flakes and scum
- Keeps the finish blemish free
- Inexpensive and virtually indestructible
- Resistant to most solvents and easily cleaned.

Part no: KGP-5-K5
Pack of 5 filters

IN-LINE AIR FILTERS

4 5



Lightweight, gun mounting air filter.

- High efficiency action traps water, oil and dirt
- Incorporates multi-layered, high efficiency filter pads
- Minimal pressure drop and long service life
- Tough, solvent resistant acetal housing with 1/4" threads
- Lightweight design (only 50 grams) does not affect balance.

Part no: HAF-507

SUCTION CUP LID GASKETS

4 5

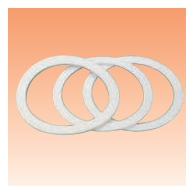

Ready to use, purpose fit suction cup lid seals.

- Choose between Tri-seal or traditional leather
- Handy packs of 3 replacement gaskets
- Fits all DeVilbiss KR type suction cups.

Part no's:
KR-11-K3 Tri-seal gaskets.
KR-69-K3 Leather gaskets

GRAVITY GUN STANDS

4 5

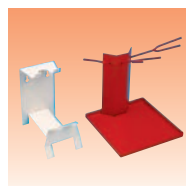

Stable metal workbench gun stands.

Part Number	Description
GFV-50F	Single gravity gun bench top stand
GGs-1	3 gun stand

MINI-FILTER (FLUID) 4

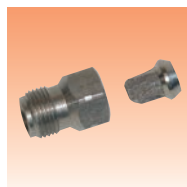

Stainless Steel final filter for all types of Spray Guns.

- Lightweight compact design
- Small internal volume – reduces paint wastage during cleaning/purging
- Fully Stainless Steel
- For use with waterborne and solvent based materials.

Part no: MF-6B-100B

Mini-Filter Pt No	Mesh size	Filter cartridge only	Thread
MF-6B-70B	200 micron	MFC-70	3/8" BSP
MF-6B-100B	149 micron	MFC-100	3/8" BSP
MF-6B-150B	100 micron	MFC-150	3/8" BSP
MF-6B-200B	74 micron	MFC-200	3/8" BSP

DEVILBISS EYE PROTECTION GOGGLES 4 5



The use of goggles with an air fed or cartridge half mask respirator is strongly recommended. The MPV goggles are light and comfortable to wear and provide impact resistance in accordance with EN166. The lens is treated with an anti-mist agent and the frame is manufactured in clear flexible PVC.

Part no: MPV-4006

- Modern, comfortable, lightweight design.
- Protects against impact from dust and liquid droplets.
- Adjustable and elasticated headstrap.
- Optically clear acetate lens with anti-mist treatment.
- Weight - 90 grams.
- Replaceable tear off overspray shields.

REPAIR KITS (AIR REGULATOR) FOR PRESSURE CUPS/TANKS 4 5



Tank/Cup	Part Number	Description
KB-522-B	KK-4887-2	Remote Cup
80-600-CE	80-617	Steady-Grip Pressure Cup
83C-210 10L	KK-4977	Zinc Plated Pressure Tank
83Z-211 10L	KK-4977	ST ST Pressure Tank
83G-1013 40L	KK-4977	Galvanised Pressure Tank

Refer to Product Service Bulletin for more information.

SERVICE KITS DVP DIAPHRAGM PUMPS 4 5



DVP Type	Part Number	Description
DVP-510 / AN	KK-4630	Diaphragm and Pin
	KK-4631	Fluid valve for standard pump
	KK-4633	Reverse Switch Valve
	KK-4634	Pneumatic distribution kit
DVP-510	KK-4632	Fluid Valves for Ceramic Pump

SERVICE KITS DX70 DIAPHRAGM PUMPS 4 5



Part Number	Description
DXK-1	Check valve seal kit x 4
DXK-2	Check valve kit x 4
DXK-3	Diaphragm kit x 2
DXK-4	Shaft & seal kit
DXK-5	End cap seal kit x 2
DXK-6	Caps & screws x 2
DXK-7	End cap nuts x 10
DXK-8	End cap

CONDUCTIVE GLOVES 4



Conductive Gloves pack of 12
Electrostatic Conductive Gloves provide electrostatic contact with the applicator whilst keeping the operators hands clean and protected.

Part no: 76633-00-K12

DISPOSABLE GUN COVERS 4



Disposable Gun Covers for Electrostatic Guns

Part no: 79529-00-K5 - Vector/Solo
Part no: 80395-K10 - Ransflex

PROTECTION HOSE 4



Protection hose 30mm grey for Electrostatic Guns

11775-05



Protection hose 55mm grey for Electrostatic Guns

11775-10

MULTIFUNCTION ELECTROSTATIC METER 4



The multi-function electrostatic spray meter uses one meter to serve multi functions in electrostatic spray finishing. The meter can be used to measure conductivity, paint resistance, short circuit current, resistance and high voltage. The meter is available in individual kits focused on each function or a deluxe kit, which includes accessories to perform extra functions.

Part no: 76652-03

DELUXE TEST EQUIPMENT 4



Ransburg test equipment provides a means of achieving an optimum finish – time after time by controlling and monitoring coating conditions. This comprehensive range of testing equipment (complete with a tough protective carrying case) assures a quality finish, less downtime and less paint waste. All Ransburg test equipment is compact and light-weight with accurate, digital readouts giving per-second updates.

- Kit includes, Paint Test Probe, Sprayability/Paint Test Meter, Gun Output Test Leads, kV Test Probe Kit
- Ground testing of conveyed products
- Certified to ISO and ASTM standards
- Includes rugged carrying case.

Part no: 76652-04

SPRAY GUN SERVICE KITS

Manual Spray Guns

Gun Type	Kit	Description
Advance HD	GTI-428-K5	Seal and Pin Kit
Suction/Gravity/Pressure	PRO-415-1	Spray Gun Service Kit
AGP/AGPV/AGT	AGX-7-K2	Packing Spring Set
	KK-4690	Piston Repair Kit
	GTI-425-K	Baffle
Compact - Suction/Gravity/Pressure/	SPK-101-K	Air Valve Service Kit
	SPK-102-K	Retaining Ring Assembly
	SPK-401-XX	General Service Kit incl. Tip and Needle
	SPK-402-K	Service Kit With Seals and Springs
EGA/EGHV	KK-5044	Gasket & Seal Kit
FLG-3 Gravity	FLG-488	Gasket & Seal Kit
FLG-5 Gravity / Suction	K-5030	Baffle Replacement Kit
	K-5040	Repair kit - seals and springs inc. tool
FLG-5 Pressure	K-5032	Baffle Replacement Kit
	K-5044	Repair kit - seals and springs inc. tool
GTi Gravity/Suction	GTI-414-K	Needle Adjusting Screw
	GTI-416-XX	General Service Kit incl. Tip and Needle
	GTI-425-K	Baffle & Seal Assembly
	GTI-445-K2	Needle Packing
	JGK-449-K	Air Valve Kit
	KK-4585	Gun Maintenance Kit
GTi Pressure	GTI-414-K	Needle Adjusting Screw
	GTI-425-K	Baffle & Seal Assembly
	GTI-426-XX	General Service Kit incl. Tip and Needle
	GTI-445-K2	Needle Packing
	JGK-449-K	Air Valve Kit
	KK-4585	Gun Maintenance Kit
GFG HD/GTi HD/JGA HD/SRi HD/PRI HD/	GTI-428-K5	Seal and Pin Kit
	PRO-415-1	Spray Gun Repair Kit
JGA/JGV/GFG	GTI-414-K	Needle Adjusting Screw
	GTI-445-K2	Needle Packing
	JGK-449-K	Air Valve Kit
	KK-4502-XX-H	General Service Kit incl. Tip and Needle
	KK-4558	Gasket & Seal Kit
	KK-4585	Gun Maintenance Kit
MSAT	GTI-414-K	Needle Adjusting Screw
	GTI-425-K	Baffle & Seal Assembly
MSVAD-529	KK-5037-1	Gasket & Seal Kit
PRI Gravity	GTI-414-K	Needle Adjusting Screw
	GTI-425-K	Baffle & Seal Assembly
	GTI-445-K2	Needle Packing
	JGK-449-K	Air Valve Kit
SRi Gravity	SRI-416	Gasket & Seal Kit



Part no: KK-4502-XX-X

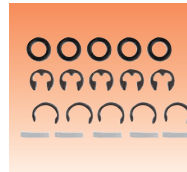

Part no: GTI-428-K5

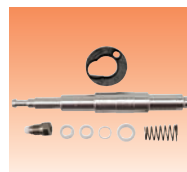

Part no: K-5044-N

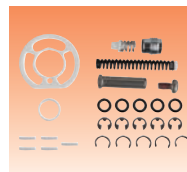

Part no: PRO-415-1

Automatic Spray Guns

Gun Type	Kit	Description
95A	54-3579	Repair Kit
460	250035	Repair Kit
550	54-3121	Repair Kit
AA4400A	SPK-119	Dynamic Seal Kit
	SPK-120	Needle Seal Kit
	SPK-121	Manifold Seal Kit
AGG	KK-4501-XX-X	General Service Kit incl. Tip and Needle
AGGS	KK-4566-XXX	General Service Kit incl. Tip and Needle
AGN	KK-4998	Repair Kit
COBRA 1	SPK-117	Seals
COBRA 2	SPK-109	Manifold Seals - Viton Extreme
	SPK-118	Dynamic Seals - Viton Extreme
GTI-A	GTIA-406-XXX	General Service Kit incl. Tip and Needle
MAG AA	54-5307	Seal Kit

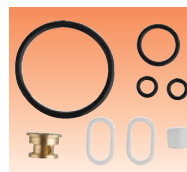

Part no: SPK-117

Airless and Air Assisted Airless Spray Guns

Gun Type	Kit	Description
A3500/A7500	54-5760	Airless Gun Repair Kit
AA1500	54-4970	Repair Kit
AA4000	54-4993	Repair Kit
	54-5447	Cartridge Assembly
Airless 1	6-236	Service Kit
AA4400M	54-5826	Fluid Needle Kit
	54-5827	Filter Bracket Kit
	54-5829	Body Bushing Kit
	54-5835	Trigger Spares Kit
	54-5838	Fluid Inlet Kit
HAP-50D	0114-013559	Seal Kit
	0114-013560	Repair Kit
HAP50F	0114-013560	Repair Kit

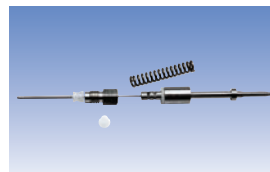

Part no: 54-5826

1 Tips/needles = Stainless Steel as standard 2 Stainless Steel fluid passageways
 3 Optional = Tungsten Carbide and hardened tips/needles 4 Substrate = Wood, metal, plastic and others 5 Substrate = Ceramic and glaze



Operator Training Support

We conduct regular operator training courses throughout the year in our fully equipped training centre's in Bournemouth, Valence and Dietzenbach.

The "modular" training courses cover all aspects and technologies used in the field of Spray Finishing. Delegates are able to gain valuable "hands-on" and "theoretical" experience with the advanced range of finishing products available, featuring the world renowned brands of Binks, DeVilbiss and Ransburg. Training is also provided on the industry specific health & Safety and statutory (ATEX/CE) requirements necessary in the demanding Spray Industry. The course agendas and dates are available on request.

Training Program

1 and 2 day courses are available for many different products and technologies and are customised for customers and our distributor personnel (Sales, Service & Technical). Our professional trainers utilise the very latest training techniques and facilities to provide delegates with everything necessary to begin using and servicing our finishing equipment. Upon completion of the modular training courses a professional training certificate will be presented to the delegates to confirm the specific training received.

Training modules include:

- P1 Manual Spray Guns
- P2 Automatic Spray Guns
- P3 Electrostatic Spray Guns
- P4 Pump and Fluid Handling inc; Pressure tanks, Regulators and Agitators
- P5 Plural Component 2K Magic Flow
- R1 Electrostatic Gun Repair
- R2 Pumps and Fluid Handling Repair
- R3 Manual and Automatic Spray Gun repair (Conventional and Trans-Tech/HVLP).

Quality policy

We continually strive to reliably deliver world class products that meet and exceed the expectations of our customers in respect of price, quality, innovation, performance, service and legal / regulatory requirements. As a global company operating through decentralised manufacturing units with a regional customer focus. Within the manufacturing scope of our business is a product range that extends from manually operated spray guns through to electrostatic spraying systems. Specific provision is made for products intended for use in potentially explosive atmospheres as defined within the Atex directive 94/9/EC in accordance with annex IV, by the implementation of BS EN 13980:2002 and is supplementary to the ISO9001:2000 Quality Management System. Defining and measuring Quality Objectives as a result of planned reviews and audits forms the basis for continuous improvement of our business. New objectives can be implemented at any time and are directed through the organisation as appropriate.



Follow us on facebook
[www.facebook.com/
 devilbissbinksransburgbk](http://www.facebook.com/devilbissbinksransburgbk)



Follow us on LinkedIn
[http://www.linkedin.com/
 company/finishing-brands-europe](http://www.linkedin.com/company/finishing-brands-europe)



On-time Deliveries and Keeping you Informed

Diamond and Sapphire Partners Europe

Unique commercial advantage

Diamond and Sapphire Partners are the highest level distributors and are our certified centres of excellence in your locality. A Diamond or Sapphire Partner provides the complete solution for all your finishing requirements. They are able to put the global resources of the company at your disposal and use the company's wealth of experience in finishing technology to answer your problems and give you a unique commercial advantage. For the name and address of your nearest Diamond or Sapphire Partner please contact us.

Multilingual Literature and Product Service Bulletins

We produce a wide range of all encompassing multi-lingual literature covering all markets and applications. A detailed list of literature is available via the European web site www.finishingbrands.eu. Literature is also available by contacting us direct.

The Binks, DeVilbiss, Ransburg Europe Product Finishing web site is dedicated to provide finishing solutions for users operating in all application markets. The site has been built with multi-lingual options in English, French, German, Italian, Spanish, Russian, Turkish, Polish and Arabic. More languages are under construction. Visitors will find the web site extremely easy to navigate as the site has been constructed using all of the very latest high speed technology includes a complete reference to all technical documentation, service bulletins and literature. It is the intention to ensure this site is always kept up to date with recent news features, promotions and regular additions providing the latest information on Finishing Products and Services.

GreenSpray programme

Call today for a free GreenSpray audit. Our team of experts can conduct a free audit of your finishing facility and offer constructive help and advice to provide practical solutions and recommendations to everyday Finishing Room challenges. This free end user programme can very often result in reduced overheads, lower maintenance costs, improved production speeds or better operator practices for our valued customers.

Online Webshop

We have two web shops to serve our distributors specific needs dedicated to Industrial/Refinishing and Automotive requirements. Here are the web shop addresses:-
Industrial & Refinishing webshop: www.finishingbrandsshop.eu
Automotive webshop: <http://webshop.finishing-brands.eu>

▪ Sign up/Log in ▪ On Line Order placing ▪ Pricing ▪ Discounts ▪ Delivery ▪ Track your orders.

Once you have placed your orders you will soon receive an order acknowledgement detailing the items ordered, discounts and anticipated shipping dates. Web placed orders may be subject to additional discounts. All orders received are subject to the terms and conditions of sales of Finishing Brands Europe (UK & Germany).



Follow us on twitter
<https://twitter.com/FinBrandsUK>



<http://www.youtube.com/user/FinishingBrandsEuro>



DeVILBISS®

Ransburg®

BINKS®

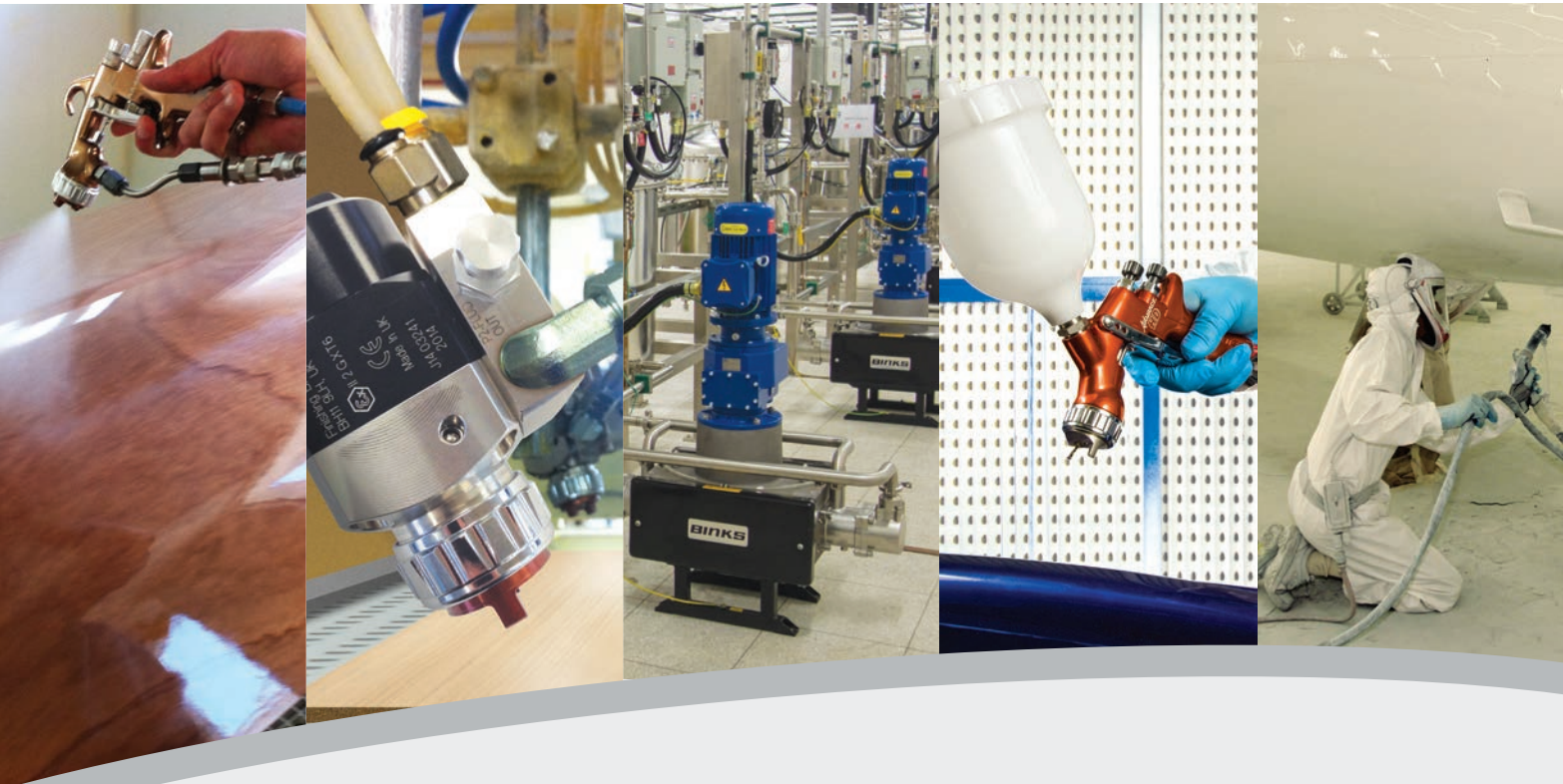

Finishing Brands (UK) Limited
 Ringwood Road, Bournemouth, Dorset
 ENGLAND BH11 9LH
 Tel: +44 (0) 1202 571111
 Fax: +44 (0) 1202 573488
 Email: marketing-uk@carlisleft.eu



Finishing Brands Germany GmbH
 Justus-von-Liebig-Strasse 31,
 63128 Dietzenbach GERMANY
 Tel: +49 (0) 6074-403-1
 Fax: +49 (0) 6074-403-281
 Email: marketing-de@carlisleft.eu



Surfaces et Finitions
 163-171 Avenue des Auréats, BP 1453
 26014 Valence cedex FRANCE
 Tel: +33 (0) 4 75 75 27 00
 Fax: +33 (0) 4 75 75 27 59
 Email: marketing-fr@carlisleft.eu

Sales and Service through our Global Network of Industrial Distributors

Finishing Brands Locations

Americas: **USA ■ Mexico ■ Brazil**
 Europe/Asia/Africa: **United Kingdom ■ France ■ Germany ■ India**
 Pacific Rim: **China ■ Japan ■ Australia**

www.finishingbrands.eu

DeVILBISS

Ransburg

BGK

BINKS

Finishing Brands®

A **CARLISLE** COMPANY