

The Complete Car Refinish Programme



German Engineering

Spray Guns | Cup Systems | Breathing Protection | Air Filtration | Accessories



Perfect Paint Application

The Leading Equipment for Professional Collision Repair

The quality of a paint job is primarily assessed through visual factors, such as colour match, colour effects, gloss, distribution, etc. The spray gun plays a crucial role in the coating process and significantly contributes to ensuring high quality standards. Consistency in the quality standard is a basic requirement during the entire coating process.

High quality, state-of-the-art spray guns are of vital importance for a secure work process. At the same time, it also must be ensured that **technically clean compressed air** is available to achieve the expected high-quality finishes. Effective **health protection** to preserve the physical capacity of the staff on the shop floor is another important element.

For all of these areas, SATA offer product solutions designed to meet the daily requirements in a bodyshop.

This brochure gives you an overview on the large SATA product programme.





FOR MORE INFORMATION:

- Topcoat spray guns (pages 4 – 9)
- Design and Airbrush (page 10)
- Primer and filler spray guns (page 11)
- RPS multi-purpose cups (pages 12 – 13)
- Breathing protection and air filtration (pages 14 – 19)
- Material supply systems (pages 20 – 21)
- Cleaning systems (pages 22 – 23)
- SATA trueSun (pages 24 – 25)
- Accessories (pages 26 – 27)

The new SATAjet® X 5500. Revolutionary. Efficient. Silent. Consistent.

State-of-the-art paint systems and the latest application recommendations open up new possibilities, but also pose new challenges for professional painters. The SATAjet X 5500 featuring the new X-nozzle system now defines a wholly new application standard for the future.

The concept of this nozzle system is easy and straightforward to understand: Both proven application technologies – HVLP and RP – remain available, but now each of them with the additional choice between "I" and "O"-nozzle sets. In line with the increasing nozzle sizes within each of the respective technology (HVLP / RP), the material flow rate increases too with constant increments – which means that the spray fan size and width remain unchanged across the entire nozzle spectrum. In essence, end-users can now rely on a transparent and consistent system which offers them clear and well-structured application options.

The "I"-nozzles produce a parallel spray fan pattern with a minimal dry zone and a drier centre which is ideal for painters preferring a **reduced application speed** and maximum application control during the painting process. The **film build per coat** in comparison to an "O"-nozzle of the same size is **slightly reduced**.

- Parallel spray fan with minimal dry zone
- Improved control during application
- Reduced film build per coat compared to the nozzle set currently in use or the "O"-nozzle

"O"-nozzles do have an oval-shaped spray fan pattern with a larger dry zone and a wet core to accommodate **increased application speed** at the expense of slightly less application control during the painting process. The **film build per coat** in comparison to an "I"-nozzle is **slightly higher**.

- Oval-shaped spray fan with larger dry zone
- Wet core for increased application speed
- Film build per coat slightly higher compared to the "I"-nozzle





PRODUCT BENEFITS

- Revolutionary: The X-nozzles are taking atomisation to a whole new level
- Noticeably quieter: Whispering nozzle™ due to optimised air flow geometry, reduced noise level in the relevant sound frequency ranges
- Individual: Matches any application requirement, such as specific characteristics of the paint system, climatic conditions and application method (application speed/application control)
- Precise: Optimised material distribution for enhanced spraying uniformity and atomisation with both spray fan shapes
- Low maintenance: No air distribution insert required, thus also ensuring a much easier and faster cleaning

process

- Consistent: Constant fan size across the entire nozzle spectrum (within each respective atomisation technology) with linear increases of the material flow rate
- Efficient: The optimised atomisation concept enables to realise considerable material savings using the same application method as before



Supreme flexibility – The SATAjet® 5000 B

PRODUCT BENEFITS

- Optimised nozzle concept for highest possible versatility
- Ergonomically formed gun handle
- Pearlodised™ is a technical enhancement of the “pearl-chrome” surface to further improve corrosion resistance as well as to minimise cleaning effort and maintenance
- Easy to operate control elements
- Safely positioned trigger sleeve – for easy, safe and quick insertion of the paint needle
- Swivel joint with high performance seal
- Identical, compact gun handle shape for both Non-Digital and Digital models
- Optimised round / flat fan control with half a turn only

Various practical characteristics:
(for explanations see fold-out page)



Versatility

The premium spray gun SATAjet 5000 B sets new quality standards, while painting has become as easy as never before. Being extremely versatile in terms of application distance and inlet pressure, this new high performance spray gun is leading the way. Now, painters have the possibility to set pressure and distance as required by the paint to be applied, the climatic conditions and the work method – to achieve perfect finishes.

Ergonomics at its finest

The design of SATAjet 5000 B has been created by the professionals at the Porsche Design Studio who have translated pure functionality into aesthetic form together with the specialists at SATA. Due to the optimised shape of the gun handle, the spray gun fits perfectly in the palm of the hand. In addition, the gun handle of the digital version is identical in size to the standard model which makes it the perfect spray gun for all painters, regardless of the size of their hands.



SATAjet® 5000 B RP®



SATAjet® 5000 B HVLP
(DIGITAL version)



SATAJET 5000 B PHASER

A tuxedo is not for every day. The best china is reserved for special occasions only. And with the new SATAjet® 5000 B PHASER™, it is not for the average. It is made for those special moments.

Combining a unique look with high-quality materials and sophisticated technical solutions unusual for a piece of spray equipment, the PHASER™ offers a whole new view on spray gun design.

Technologically, the PHASER™ is identical to the SATAjet® 5000 B premium spray gun – utilising the same nozzle concept, it also has all other proven technical features which already define the SATAjet® 5000 B series as an outstanding spray gun.



Top Coat Spray Guns for Perfect Finishes

SATA high performance spray guns are used for the application of top coat materials in car refinishing, **with their nozzle sets being designed for the application of modern base and clear coats from all leading paint manufacturers** and fine-tuned during the final quality inspection process at SATA to ensure that your paint jobs meet highest demands in terms of **brilliance, desired colour effects, uniform material distribution, gloss and colour match.**

- SATA high performance spray guns are made of forged aluminium and finished with a high-quality chrome plating
- With their fluid tips and paint needles being made of stainless steel, they can be used for the application of both solvent-based and waterborne paints
- Round/flat fan control and air micrometer are standard features.
- The gun handle as well as all control elements are ergonomically formed for perfect gun control
- Robust in their design, SATA spray guns are low in weight
- The spray guns are easy to clean and maintain, due to self-adjusting seals, paint needles protected from paint mist, sturdy air cap threads and short material passages
- The inlet pressure can be precisely adjusted and controlled either with an integrated or a retrofit electronic pressure gauge

SATAjet® 4000 B

Shape and function blending into one unique experience

The perfect complement or alternative to SATAjet 5000 for every bodyshop accomplishing car and utility vehicle repair or full paintings.

- A uniform and perfectly shaped spray fan allows rapid application speed and brilliant finishes
- Lightweight and pleasantly ergonomic spray gun
- **Optional:** SATAjet 4000 B DIGITAL with integrated electronic inlet pressure adjustment

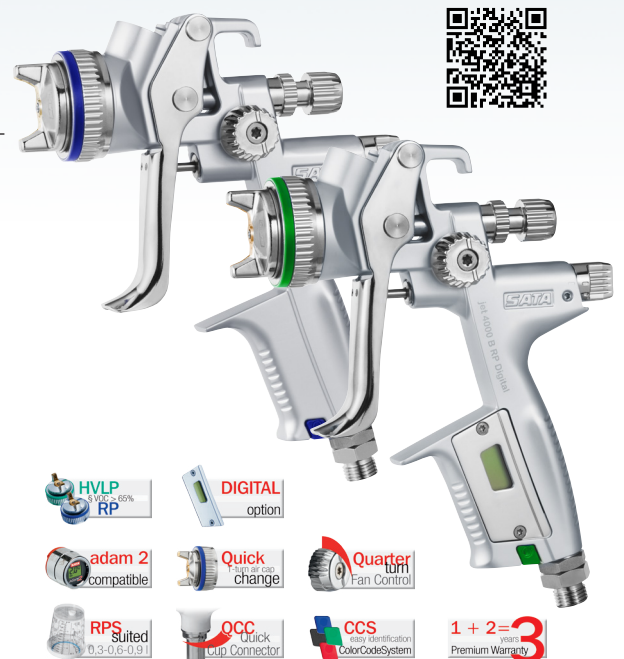

SATAmijnjet® 4400 B

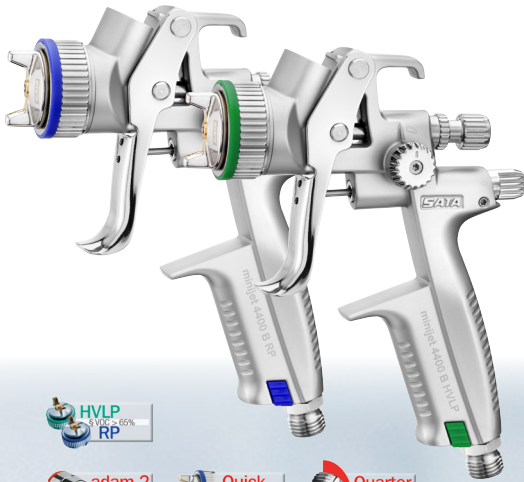

Brilliance in Miniature

Compact, lightweight gravity flow cup spray gun for small surfaces and areas of difficult access as well as for custom paintings.

- Easy to clean, corrosion-resistant pearlodised™ surface
- Special "SR" nozzle sets for Spot Repair
- Large QCC cup connection for all cup sizes
- Air consumption: RP: 200 NI/min at 2.5 bar; HVLP: 120 NI/min at 2 bar

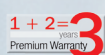

SATAjet® 3000 K

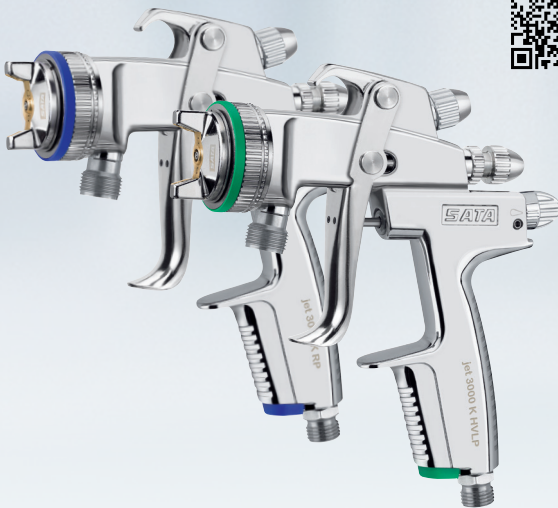

The pressure-fed gun for large surface applications

Painting entire utility vehicles requires pressure fed spray guns.

- High surface efficiency due to material supply from pressure tanks or via double diaphragm pumps
- Wide, smooth and homogeneous spray fan for perfect finishes at high application speed
- Extremely robust gun model with axial round/flat spray control
- **Optional:** For permanent use or abrasive materials: fluid tip and paint needle with lifetime prolonging surface



SATAjet® 1000 K

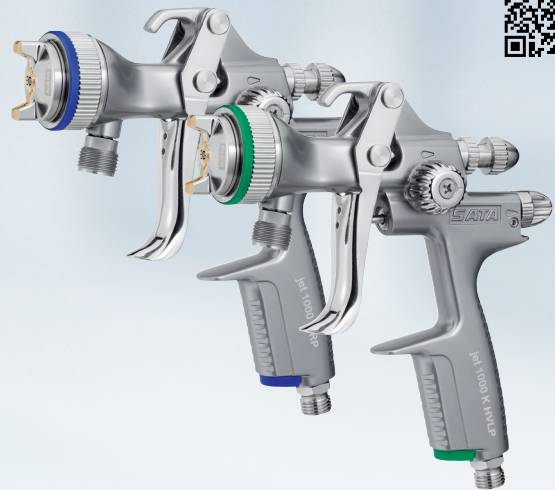

The lightweight universal pressure-fed gun for large surface applications

- Allows connection to all sorts of material supply systems, such as pressure pots, double diaphragm pumps and central paint supply systems
- Suitable for the application of various materials – waterborne or solvent-based
- Sturdy, easy clean surface
- Special air flow at the air cap horns reduces overspray settling at the air cap
- **Optional:** fluid tip and paint needle with lifetime prolonging surface



Design and Airbrush Guns

To paint creative, fancy motives, many artists from the airbrush scene prefer SATA design guns. **They are especially suitable for creating fine dots, delicate lines and contours.** Different models are available to suit your specific application needs.



SATAjet® 20 B Design-Set

- Airbrush gun with round spray nozzle, ergonomically shaped like a regular spray gun for fatigue-free work
- Durable and low maintenance
- In addition to the SATAjet 20 B 0.5, the SATA design set also contains all necessary accessories



SATA® graph™ 1

For beginners

- With double action system for separate air and material control to achieve special effects
- Versions with gravity flow cup or suction cup



SATA® graph™ 3

For professionals

- Features similar to SATAgraph 1, however, with additional removable needle cap to allow drawing finest lines
- Material flow control
- Four nozzle sizes available



SATA® graph™ 4

The universal spray gun

- Simultaneous air and material control via the trigger for a familiar action
- Removable needle cap to allow drawing finest lines
- Simply turning the gun body 180° and replacing the cup quickly converts the airbrush from gravity to siphon and vice versa



SATAmijet® 4400 B Design-Set

- Perfectly suitable for graphic designs, automotive custom painting, artwork and calligraphy as well as spot repair
- In addition to the SATAmijet 4400 B 1.0, the fully equipped SATA design set also contains all necessary accessories



Special Spray Guns for Primer Materials

Prep materials such as primer, filler and spray putty fulfill an important function within the paint process. To economically apply these primer materials, the use of the SATAjet 100 B F and B P are recommended. The material is applied with extremely low overspray allowing little masking efforts.

SATAjet® 100 B F™

RP® and HVLP – for primer and filler application

Primer and filler application with little overspray saves paint material and reduces masking effort. A smooth material distribution reduces subsequent sanding efforts. Already with an inlet pressure of 0.5 bar, the spray fan can be flexibly and precisely adjusted even to small spot repair areas.



- Sturdy spray gun with anodised spray gun body
- Fully equipped with round/flat fan control and material flow control as well as air micrometer
- Comfortably lightweight and ergonomically optimised spray gun
- Little cleaning and maintenance
- Versatile use due to each four different RP and HVLP nozzle sizes



SATAjet® 100 B P™

For spray putty application

The nozzle set "P" creates high film builds. The sharp-edged spray fan allows precise spray putty application.



SATA® RPS® – The Original.

The safe, refillable cup system for professionals: easy, perfect and without compromise

SATA RPS (Rapid Preparation System) is the ideal cup system for shops focusing on **perfect finishes and high profitability**. It makes a painter's life much easier, considerably increases productivity and drastically reduces the consumption of cleaning solutions and solvents.

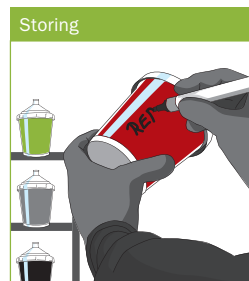
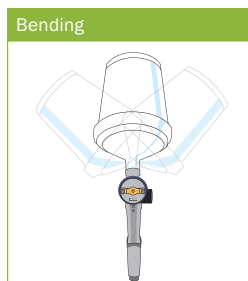
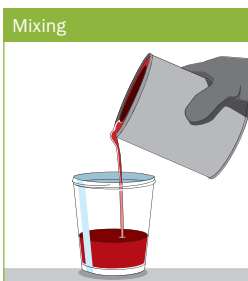



SATA® RPS wall dispenser®

Also available as UV version



PRODUCT BENEFITS

Principal benefits of the original SATA RPS system:

1. The bending cup can be adapted to the gun position which allows easy painting of door sills (**from the side**), or fenders "**upside down**").
2. The threaded connection between cup and lid ensures great stability. Even when touching an obstacle, the cup will remain safely in place and firmly connected to both lid and spray gun.
3. Whenever this is required, the threaded connection also helps to quickly detach the lid – without spilling paint onto the workplace. The paint strainer can be replaced at any time – e.g. for storage.
4. By squeezing the cup, a low pressure is created inside the cup which causes an efficient material passage drain while the gun trigger is pulled. This helps to keep the workplace clean when the cup is detached from the gun.

CHARACTERISTICS

- Easy to use – only 3 parts
- Constant material flow, helping the painter achieve perfect coating results just like child's play
- Allows very quick colour changes– cleaning becomes a secondary issue
- The special lid shape ensures complete consumption of the paint contained in the cup
- Large number of mixing ratios (up to 100 variations)
- Fits directly on all SATA spray guns – no adapters required
- Bending cup system
- Threaded connection to keep cup and lid safely in place and firmly connected to the spray gun
- Squeezing the cup causes a vacuum which allows detaching the cup without paint spills
- Cup can be refilled
- Strainer can be replaced
- Stable cup ensures safe storage of leftover material
- Reduces cleaning efforts and solvent consumption
- Available in the 3 cup sizes 0.3 l, 0.6 l and 0.9 l
- Different strainer types available

For selecting the correct sieve fineness, please ask your paint manufacturer.

Available in 3 different cup sizes

0.9 l



0.6 l



0.3 l



SATA® air vision 5000: Breathing Equipment to Protect Your Health

Your employees deserve **absolute** safety by means of **clean air supplied from outside the spray booth.**

The new SATA air vision 5000 puts the focus on effective health protection and lets you experience a whole new and comfortable way of breathing, due to a **completely re-designed breathing air supply system.** With its modern, ergonomic design, the hood can be adapted to fit almost any head shape, allowing the individual adjustment of its effective circumference, height and position.



SATA air vision 5000 Structure



PRODUCT BENEFITS

- High breathing air quality: The air supply independent of the ambient air eliminates all potential risks for the painter by contaminated spray booth air possibly arising from saturated filter cartridges
- No inhalation resistance, very comfortable breathing
- High protection level, suitable for long application intervals
- Protects up to 100 times the TRK-value*
- Visor allows one-hand operation
- Non-reflecting view due to solvent-resistant special foil
- Little operating costs, quick pay-off of purchase costs
- Ergonomic design with a host of options for individual adaptations
- Soft-stream flow-optimised air distribution in the hood
- Large field of vision: approx. 297 cm² at a maximum possible angle of 220°
- Reduced sound level: 64 dB (like a conversation in 1m distance)
- Rigid skull cover for safer work conditions
- Replaceable visor foils allow unchanging clear view onto the workplace
- The SATA CCS Disks (Color Code System) allow to personalise hood, SATA air regulator and SATA air carbon regulator
- To be used in conjunction with a filter unit, preferably SATA filter 484; air supply to be effected via special compressed air hose



* TRK = Technical Reference Concentration (TRC)
For additional information, visit: www.sata.com/satavision5000



Increased air flow volume creates the required excess pressure inside the hood which prevents overspray intrusion

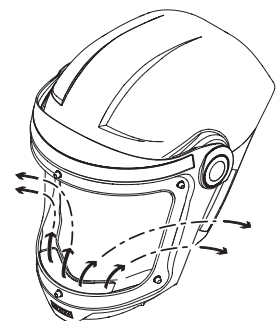

SATA® vision™ 2000

PRODUCT BENEFITS



- High breathing air quality due to air supply independent of the ambient air, no inhalation resistance, high breathing comfort
- High protection level, suitable for long application intervals
- Protects up to 100 times the TRK-value*
- Visor allows one-hand operation
- Non-reflecting view due to solvent-resistant special foil
- Little operating costs, quick pay-off of purchase costs
- To be used in conjunction with a filter unit, preferably SATA filter 484; air supply to be effected via special compressed air hose

SATA vision 2000 system design with SATA filtering systems

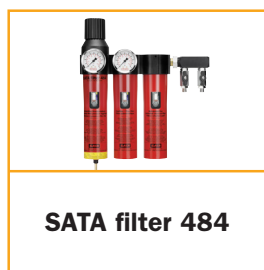
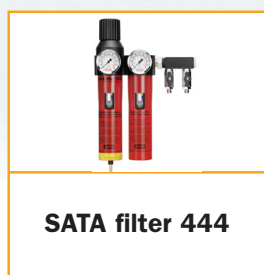

SATA® air star® F | SATA® air star® C



SATA® air star® F

- Breathing protection mask which is independent from the ambient air with exchange filter
- Unrestricted mobility
- Small investment
- High wearer comfort, free vision (goggles required)
- Easy handling and safe seat
- Pre-filters to extend the lifetime
- Relatively low inhalation resistance
- 4 pointed straps for easy handling and safe seat
- Not suitable when applying materials containing isocyanates



SATA® air star® C

- Supply of clean breathing air independent from the ambient air – also outside the spray booth
- Free vision (protective goggles required)
- High breathing air quality due to air supply independent of the ambient air, no inhalation resistance, no accumulation of heat and humidity inside the mask
- Protects up to 100 times the TRK-value*
- Excellent fit for any type of facial contours
- Very light and comfortable
- 4 pointed straps for easy handling and safe seat
- To be used in conjunction with a filter unit, preferably SATA filter 484; air supply to be effected via special compressed air hose

SATA – Ensuring clean atomisation and breathing air

Every bodyshop requires compressed air for many different applications, such as for painting, operation of supplied-air respirator systems, paint pressure tanks, material pumps, blow guns or cleaning devices. According to the field of application, there are different requirements concerning air purification: In any case, SATA offer the appropriate solution.

SATA filter 400 series



The filter series for the spray booth

The SATA filter 444 is recommended with solvent-based paint. To achieve highest safety with breathing protection systems and for the application of waterborne paints, a SATA filter 484 is essential to remove harmful oil vapours by means of the activated charcoal filter stage.

- Maximum protection for the painter
- Reliably prevents expensive coating flaws
- User-friendly and easy to maintain
- Quick and easy installation
- Economical and efficient
- Extremely high air flow (approx. 3,600 NI/min at 6 bar)
- Robust, durable filter canisters
- Suitability of the triple-stage filter (SATA filter 484) for applying waterborne paints and for breathing
- SATA filter timer for observing the filter cartridge replacement intervals. Attention: In case of a particularly high concentration of harmful substances in the compressed air, filter cartridge replacement may be required at an earlier time than indicated.



SATA® filter timer

To remind all users of the frequently required filter cartridge replacement, SATA is now equipping all filter units with the SATA filter timer.

Handling the SATA filter timer is as easy as that:

- Upon putting the new filter cartridge into operation for the first time, press the filter timer activating button.
- The display will gradually grow red, showing the time elapsing which corresponds to the filter cartridge saturation under normal circumstances.
- The filter cartridge must be replaced as soon as the display is red all over.
- Attention: In case of a particularly high concentration of harmful substances in the compressed air, filter cartridge replacement may be required at an earlier time than indicated.



SATA filter 100 prep series

The filter series for the prep area

SATA filters 100 and 103 prep are low-maintenance compressed air filters for the prep area: Less coating flaws, less rework.

- Especially for air purification of the prep area
- High and safe separation efficiency (automatic condensate drain valve)
- Pressure regulation valve with pressure gauge
- Easy assembly, sturdy and low maintenance
- Attention: In case of a particularly high concentration of harmful substances in the compressed air, filter cartridge replacement may be required at an earlier time than indicated.

SATA® filter cover

- Protect your SATA filter units from overspray
- Considerably prolongs filter unit lifetime and reduces servicing efforts
- One package contains four transparent covers to be put onto the filter unit altogether. As more and more overspray settles on the top cover, just take it off, throw it away and use the next one underneath.
- Fits perfectly on all current two and three stage SATA filter units (installation on left hand or right hand side)



without SATA® filter cover

with SATA® filter cover

Material Supply Systems for an Optimised Painting Process

For the application of larger amounts of paint, the SATA material supply systems in combination with pressure fed SATA spray guns are the perfect solution. **The universally applicable systems feature easy handling, sturdy construction, long lifetime and little maintenance.**

SATAjet® 4800 K spray mix®, SATA® modulus™ *

SATAjet 4800 K spray mix – for efficient application with low overspray

- Perfectly suitable for waterborne and solvent-based paints and coating materials
- Air and material swivel joints (with ball bearing) for optimum operation
- Material supply can be quickly exchanged due to component assembly

SATA modulus piston pump system – As individual as its tasks

- Modular piston pump system – consisting of the following individual modules: pump, air, material, filter, carrier and extension
- Adapts easily to changing tasks

* Until further notice: Distribution exclusively in Germany and Austria



SATA® vario top spray™

The double diaphragm pump

- High performance diaphragm pump technology with enhanced pump capacity for high speed application
- Robust, wear resistant and low-maintenance double diaphragm technology
- Large variety of pumps for liquid transportation, material delivery and paint applications
- High profitability and fast return on investment, due to continuous material delivery and high transfer efficiency

- Ultra-fine atomisation of primer materials and topcoats in conjunction with the reliable, top quality SATA spray guns (e.g. SATAjet 3000 K and 1000 K)
- Two different versions are available: Standard version in aluminium for the application of solvent-based materials, and stainless steel version for the application of both solvent-based and waterborne materials.



SATA® paint pressure tanks



- Time saving due to continuous working without interruptions
- Pulsation free, even material supply
- Also suitable for high viscosity, paste-like or thixotropic materials
- Various equipment and special versions
- Enhanced working opportunities due to large range of accessories
- Available with a volume of 10, 24 or 48 litres



SATA® mini set™ 2

For mobile use

- Pressure pot with a volume of 2 litres
 - Handy, can be used anywhere
 - Closed system
 - Easy to clean
- Also available as complete spray unit in combination with a SATAjet 3000 K spray gun



Cleaning systems for spray guns

Spray gun cleaning is an important but understandably less popular task amongst painters. SATA cleaning devices reliably help achieve proper spray gun cleaning, thus relieving the painter. **They not only maintain proper function of the spray gun, but also increase the process security in the bodyshops.**



Zwischenreinigung mit SATA® clean RCS®

1. Flushing and cleaning of material passages and air cap (Ø approx. 20 sec.)



2. Dry-blowing (Ø approx. 5 sec.)



3. Colour change



SATA® clean RCS®

The turbo cleaner

- For bodyshops with high output and many colour changes.
- Rapid and safe colour change when using multi-purpose cups, such as SATA RPS
- Thorough cleaning of the material passages
- Eliminates the need for trips in and out of the booth, as it can be mounted inside the spray booth
- Increases bodyshop productivity
- **Optional:** Hose for extracting solvent vapours



SATA® clean RCS® compact

- To connect large cleaning agent containers
- Recommended for assembly in the mixing area
- **Optional:** Hose for extracting solvent vapours

SATA® clean RCS® micro

The compact version is also available as space-saving option with a one-chamber-system.

- To connect large cleaning agent containers
- Recommended for assembly in the mixing area
- Space-saving one-chamber system
- **Optional:** Hose for extracting solvent vapours



SATA® multi clean™ 2

Cleaning device with built-in exhaust unit

- Thorough and gentle cleaning of spray gun, cup and lid
- Low cleaning fluid consumption
- Closed, environmentally friendly system
- Brush soaked in cleaning agent for manual cleaning

SATA® trueSun™ – the daylight solution

The selection of the correct colour shade for refinishing a vehicle requires a source of light that preferably reproduces the entire colour range of visible light (daylight) as accurately as possible. The SATA trueSun LED lamp which was especially designed for this purpose allows a professional colour shade evaluation and identification within the paintshop. Any rework caused by an incorrect colour identification and the respective rectification cost involved does not leave any room for compromise when selecting the daylight lamp. Even avoiding a single rework covers the purchase cost of this high quality product.

PRODUCT BENEFITS

- Best possible near daylight reproduction of different color shades
- Uniform distribution of the light intensity across the entire light cone
- approx. 70 minutes at full light intensity
- Uniform light intensity – independent from accumulator charging condition
- Charging cycle time of 50 minutes only
- Infinitely adjustable light intensity
- Built-in charging condition display
- Near daylight reproduction of effect pigments
- Coating flaws such as mottling can be easily detected



Colour shade does not match (red tint).



Colour shade and metallic effect do not match.

Daylight lamps used for colour shade determination, by comparison



Uniform distribution of the light intensity

The uniform light distribution across the entire illuminated area simplifies the selection of the right color shade. The light intensity can be adjusted continuously via a sliding control.

The light intensity remains unchanged for the entire battery capacity.



Light cone of the SATA trueSun

Highest possible LED correspondence to daylight at maximum light power, uniform distribution of the light intensity – neutral colour temperature.



Example of high quality torch from manufacturer A

Very small, non-uniformly illuminated surface, strong yellow coloration

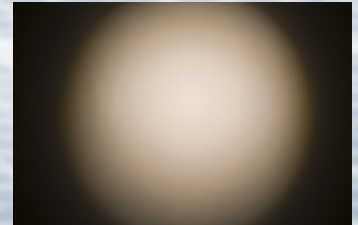

Example of daylight lamp from manufacturer B

Uniform distribution of the light intensity, but very strong yellow coloration.

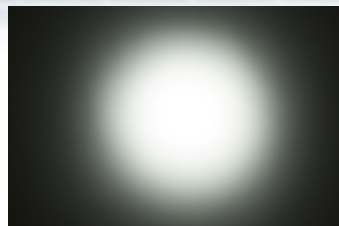

Example of daylight lamp from manufacturer C

inconsistently illuminated surface, edges appear greenish/bluish

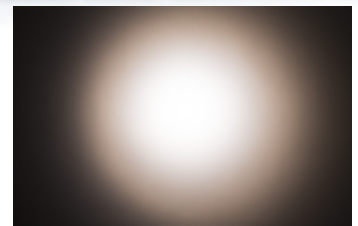

Example of daylight lamp from manufacturer D

inconsistently illuminated surface, edge appear reddish.



Colour shade and metallic effect match.

Everything for the Modern Bodyshop and Workshop

Every bodyshop should be equipped with robust grit blasting guns, spray guns for underbody protection and cavity preservation materials as well as complementing innovative accessories to improve daily work processes.



SATA® UBE™

Efficient suction cup gun to apply underbody and stoneguard underbody compound out of disposable cans.
Art. No. 12740



SATA® HRS™

Pressurised cup spray gun for cavity preservation with three quick change wands for various fields of application.
Art. No. 9795



SATA grit blasting gun

Quick and easy removal of small corrosion spots.
Art. No. 17335



SATA blow gun

Blow gun with multi nozzle for high efficiency at little air consumption.
Art. No. 15214



SATA® dry jet 2™

Special blow gun to reduce drying time of waterborne paints.
Art. No. 217489
Two blow guns mounted on a stand via quick couplings.
Art. No. 223008



SATA® Multitool

The SATA Multitool comprises of 13 different implements designed to aid the maintenance of all SATA spray guns.
Art. No. 228999

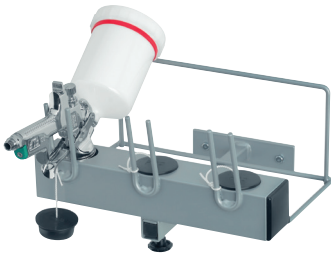

SATA® clean®
Wet holding tray for up to three spray guns. Prevents drying out of the nozzle.
Art. No. 60095



High-quality air hose for connecting spray guns and breathing protection systems
9 mm inner diameter, 10 m long, with quick coupling and nipple, antistatic, conductive, free of substances causing coating flaws, 20 bar pressure-resistant, high bursting safety.
Art. No. 53090



SATAAir tester®
For the quick and reliable test of the atomisation air in terms of substances causing coating flaws.
Art. No. 156299

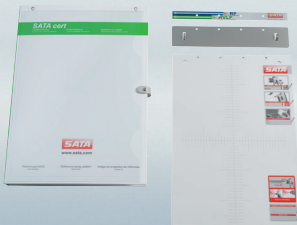

SATA® cert™
Reveal problems before they occur – with the regular control of the spray pattern.
Art. No. 161596



SATA® care set™
Bag with useful utensils for spray gun cleaning and maintenance. Framed in red colour: Not included in delivery.
Art. No. 162628



SATA® High Performance Grease
Silicone and acid-free. 100 g for spray guns.
Art. No. 48173



SATA dock
with G 1/8" male thread to retrofit analogue pressure gauges, e.g. in pneumatically operated systems
Art. No. 195925



Spray gun holder
For wall or table mounting. Useful tool for refilling SATA RPS multi-purpose cups.
Art. No. 40188



SATA® Universal spray gun and hose holder.
Art. No. 192195



Spray gun holder
For wall mounting.
Art. No. 9886

SATA® adam® 2



SATA® adam® 2 U
Air micrometer G 1/4" female thread and 1/4" male thread with SATA adam 2 display for SATA dry jet and competitor spray guns
Art. No. 195214

SATA® adam® 2 / adam® 2 mini™
Turns a non-digital spray gun into a "DIGITAL" - for retro-fitting SATA spray guns without integrated digital pressure gauge. Ensures correct setting and display of the gun inlet pressure for highest colour match precision



SATA® adam® 2
For SATAjet spray guns except SATAjet 5000 B
Art. No. 160846



SATA® adam® 2 mini™
For SATAminijet® 4400 B/3000 B and 1000 H/K
Art. No. 160879



SATA® adam® 2 / SATA® adam® 2 black
Only for SATAjet 5000 B
Art. No. 211540
Art. No. 1031723 (black)

Spray Guns

Characteristics – Meaning of symbols



VOC-compliant atomisation technology – optionally available as HVLV low pressure or RP optimised high pressure technology



Optional: With built-in electronic inlet pressure measurement



Innovative and versatile digital retrofit air micrometer



Switching back and forth from round to flat spray fan with a quarter turn only



Perfectly suitable for the use of RPS multi-purpose cups



Cup connection for quick and clean cup changes as well as easy cleaning



Quick air cap change with one turn only



For the convenient identification of your spray gun



Top quality is not enough – we guarantee it: for three years

HVLV and RP

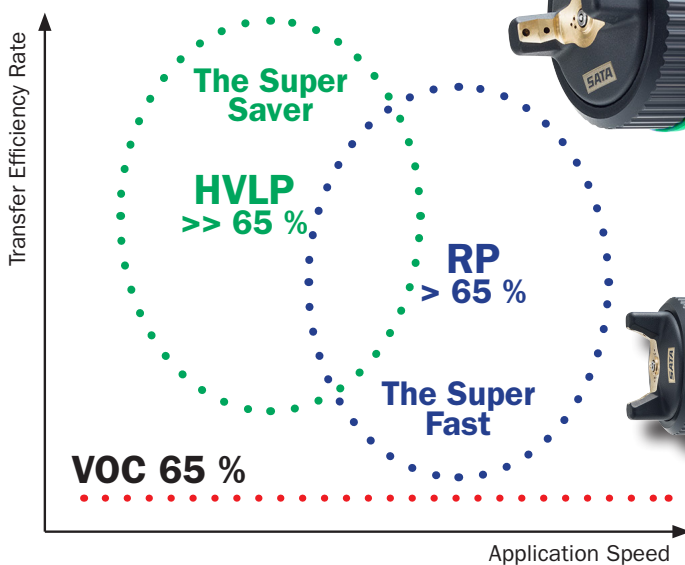

HVLV: Due to their low pressure technology, these SATA spray guns achieve extremely high transfer rates.

RP: The optimised high pressure technology allows maximum application speed.

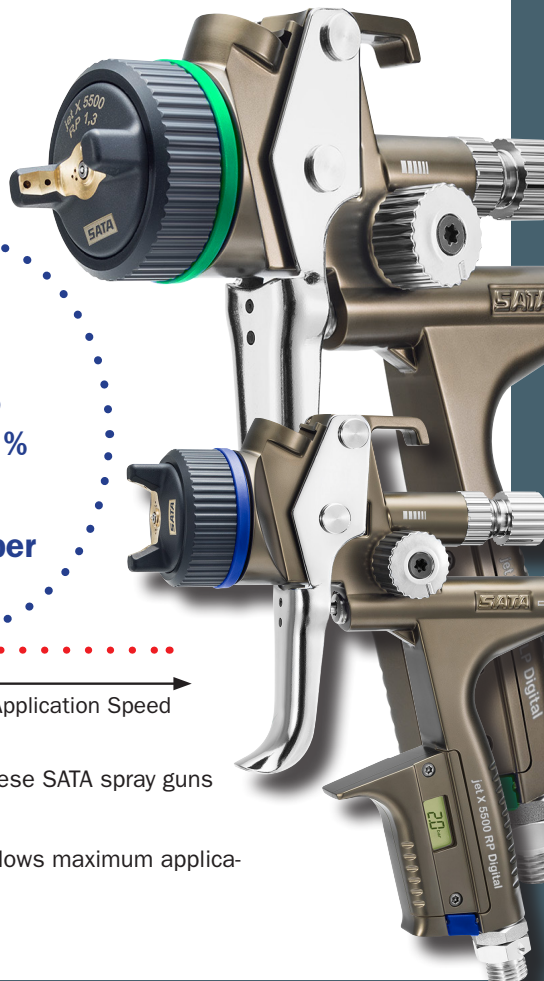

The right spray gun for your needs

The following reasons are decisive to choose the appropriate spray gun:

- The object to be painted
- The paint system
- Painter's habits
- Available air volume

Spray Guns for Automotive Painters

	The Super Saver Guns	The Super Speed Guns
Top Coat <ul style="list-style-type: none"> ■ Clear coat ■ Base coat ■ 2K single stage topcoat 	SATAjet® X 5500HVLP SATAjet® 5000 B HVLP SATAjet® 4000 B HVLP SATAjet® 3000 K HVLP	SATAjet® X 5500 B RP® SATAjet® 5000 B RP® SATAjet® 4000 B RP® SATAjet® 3000 K RP®
Primer Materials <ul style="list-style-type: none"> ■ Primer ■ Surfacer 	SATAjet® 100 B F™ HVLP	SATAjet® 100 B F™ RP®
<ul style="list-style-type: none"> ■ Polyester Primer (Sprayable Putty) 	SATAjet® 100 B P™	
Small repairs <ul style="list-style-type: none"> ■ Spot repair ■ Touch-ups/blending 	SATAminijet® 4400 B HVLP	SATAminijet® 4400 B RP®
Design	SATAjet® 20 B SATAglyph® 1, 3, 4	



SATA sets standards

... for spray guns, cup systems, breathing protection systems and compressed air filters.

Our close cooperation with painters in craft and industry as well as with the Research and Development divisions of the leading paint manufacturers enables us to create top quality products of ultimate value.

"SATA Quality" is a trusted term among painters. They know that SATA products are reliable, sturdy and ergonomic like a duck takes to water.

Together with our competent distribution partners both on the domestic market and abroad we ensure **highly performing after sales service.**

In Germany and numerous other countries all over the world, SATA is a **leading paint spray gun manufacturer.** Based on this success, we feel a strong obligation to maintain the high SATA quality standards required by our customers worldwide.



Your SATA dealer



SATA GmbH & Co. KG
Domertalstr. 20
70806 Kornwestheim
Germany
Tel. +49 7154 811-200
Fax +49 7154 811-194
www.sata.com