

---

Operating instructions and Spare parts list

# Application pump OptiSpray AP01.1

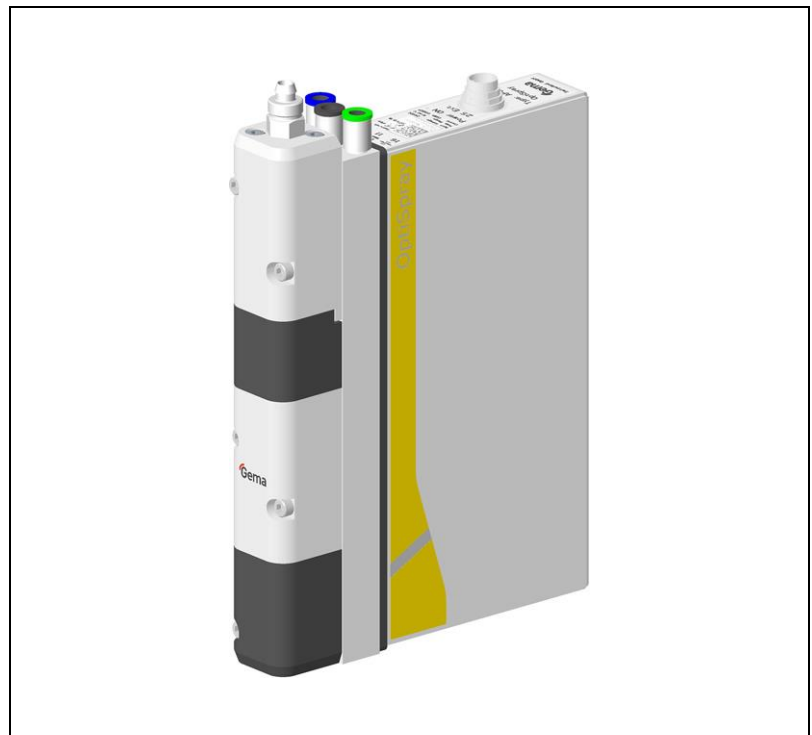

Translation of the original operating instructions

## Documentation OptiSpray AP01.1

© Copyright 2017 Gema Switzerland GmbH

All rights reserved.

This publication is protected by copyright. Unauthorized copying is prohibited by law. No part of this publication may be reproduced, photocopied, translated, stored on a retrieval system or transmitted in any form or by any means for any purpose, neither as a whole nor partially, without the express written consent of Gema Switzerland GmbH.

Gema, EquiFlow, MagicCompact, MagicCylinder, OptiCenter, OptiFlex, OptiGun, OptiSelect, OptiStar, OptiStar All-in-One and PowerBoost are registered trademarks of Gema Switzerland GmbH.

ClassicLine, ClassicStandard, ClassicOpen, DVC (Digital Valve Control), GemaConnect, MagicControl, MagicPlus, MonoCyclone, MRS, MultiColor, MultiStar, OptiAir, OptiControl, OptiColor, OptiFeed, OptiFlow, OptiHopper, OptiMove, OptiSieve, OptiSpeeder, OptiSpray, PCC (Precise Charge Control), RobotGun, SIT (Smart Inline Technology) and SuperCorona are registered trademarks of Gema Switzerland GmbH.

All other product names are trademarks or registered trademarks of their respective holders.

Reference is made in this manual to different trademarks or registered trademarks. Such references do not mean that the manufacturers concerned approve of or are bound in any form by this manual. We have endeavored to retain the preferred spelling of the trademarks, and registered trademarks of the copyright holders.

To the best of our knowledge and belief, the information contained in this publication was correct and valid on the date of publication. Gema Switzerland GmbH makes no representations or warranties with respect to the contents or use of this publication, and reserves the right to revise this publication and make changes to its content without prior notice.

For the latest information about Gema products, visit [www.gemapowdercoating.com](http://www.gemapowdercoating.com).

For information regarding patents, see [www.gemapowdercoating.com/patents](http://www.gemapowdercoating.com/patents) or [www.gemapowdercoating.us/patents](http://www.gemapowdercoating.us/patents).

### Printed in Switzerland

Gema Switzerland GmbH  
Mövenstrasse 17  
9015 St.Gallen  
Switzerland

Phone: +41-71-313 83 00

Email: [info@gema.eu.com](mailto:info@gema.eu.com)

# Table of contents

<b>About these instructions</b>	<b>5</b>
General information .....	5
Keeping the Manual .....	5
Safety symbols (pictograms).....	5
Structure of Safety Notes.....	6
Presentation of the contents .....	6
Figure references in the text .....	6
<b>Safety</b>	<b>7</b>
Basic safety instructions .....	7
Product specific security regulations .....	8
<b>Product description</b>	<b>9</b>
Intended use .....	9
Reasonably foreseeable misuse.....	10
Technical Data .....	10
Electrical data .....	10
Pneumatic data .....	10
Powder output (reference values).....	11
Dimensions .....	11
Sound pressure level .....	11
Rating plate .....	12
Design and function .....	13
Overall view.....	13
Powder hoses .....	13
Spraying air function / diffusers.....	14
Connections .....	15
Scope of delivery .....	15
Typical properties - Characteristics of the functions .....	16
Main functions .....	16
Secondary functions .....	16
Conveying direction .....	16
Powder hose rinsing .....	16
Maintenance interval monitoring.....	17
<b>Assembly / Connection</b>	<b>19</b>
Assembly guide.....	19
Connection instructions.....	20
<b>Start-up</b>	<b>23</b>
Preparation for start-up .....	23
Basic conditions .....	23
Basic information .....	23
<b>Operation</b>	<b>25</b>
Operation .....	25

Switching on and off the conveying procedure.....	25
Switching on and off the rinsing procedure .....	25
<b>Maintenance / Repairs</b>	<b>27</b>
General information .....	27
Maintenance of the dense phase pump .....	28
Maintenance schedule.....	28
Daily maintenance .....	28
Pinch valve diagnostic.....	28
Wear parts .....	28
Cleaning.....	29
Cleaning the Application pump (color change).....	29
Periodic checks .....	29
Repair work.....	30
Replacing the pinch valve hoses and filter elements .....	30
Pump disassembly .....	31
Replacing the pinch valve hoses.....	32
Replacing the filter elements .....	33
Replacing the solenoid valves for pinch valves control.....	34
Requirements on personnel carrying out the work.....	34
Replacing the solenoid valves.....	35
Replacing the Application pump in an OptiCenter .....	38
<b>Fault clearance</b>	<b>39</b>
<b>Decommissioning / Storage</b>	<b>43</b>
Shutdown.....	43
If in disuse for several days .....	43
Storage conditions .....	43
Hazard notes .....	43
Type of storage.....	43
Storage duration .....	43
Space requirements .....	43
Physical requirements .....	44
Maintenance during storage .....	44
Maintenance schedule.....	44
Maintenance works.....	44
<b>Disposal</b>	<b>45</b>
Introduction.....	45
Requirements on personnel carrying out the work.....	45
Disposal regulations .....	45
Materials .....	45
Disassembly of component groups .....	45
<b>Spare parts list</b>	<b>47</b>
Ordering spare parts.....	47
OptiSpray AP01.1 Application pump .....	48
OptiSpray Twin AP01.1 Application pump .....	50
Connecting material.....	52

# About these instructions

---

## General information

This operating manual contains all the important information which you require for the working with the OptiSpray AP01.1. It will safely guide you through the start-up process and give you references and tips for the optimal use when working with your powder coating system.

Information about the functional mode of the individual system components should be referenced in the respective enclosed documents.

---

## Keeping the Manual

Please keep this Manual ready for later use or if there should be any queries.

---

## Safety symbols (pictograms)

The following warnings with their meanings can be found in the Gema instructions. The general safety precautions must also be followed as well as the regulations in the relevant instructions.

### DANGER

Indicates a hazardous situation which, if not avoided, will result in death or serious injury.

### WARNING

Indicates a hazardous situation which, if not avoided, could result in death or serious injury.

### CAUTION

Indicates a hazardous situation which, if not avoided, could result in minor or moderate injury.

### ATTENTION

Indicates a potentially harmful situation. If not avoided, the equipment or something in its surrounding may be damaged.

**ENVIRONMENT**

Indicates a potentially harmful situation which, if not avoided, may have harmful consequences for the environment.

**MANDATORY NOTE**

Information which must be observed.

**NOTICE**

Useful information, tips, etc.

**Structure of Safety Notes**

Every note consists of 4 elements:

- Signal word
- Nature and source of the danger
- Possible consequences of the danger
- Prevention of the danger

**⚠ SIGNAL WORD**

**Nature and source of the hazard!**

**Possible consequences of the danger**

- ▶ Prevention of the danger

---

**Presentation of the contents****Figure references in the text**

Figure references are used as cross references in the descriptive text.

**Example:**

*"The high voltage (**H**) created in the gun cascade is guided through the center electrode."*

# Safety

---

## Basic safety instructions

- This product is built to the latest specification and conforms to the recognized technical safety regulations and is designed for the normal application of powder coating.
- Any other use is considered non-compliant. The manufacturer shall not be liable for damage resulting from such use; the user bears sole responsibility for such actions. If this product is to be used for other purposes or other substances outside of our guidelines then Gema Switzerland GmbH should be consulted.
- Start-up (i.e. the execution of intended operational tasks) is forbidden until it has been established that this product has been set up and wired according to the guidelines for machinery. The standard "Machine safety" must also be observed.
- Unauthorized modifications to the product exempt the manufacturer from any liability from resulting damage.
- The relevant accident prevention regulations, as well as other generally recognized safety regulations, occupational health and structural regulations are to be observed.
- Furthermore, the country-specific safety regulations also must be observed.

---

## Product specific security regulations

- This product is a constituent part of the equipment and is therefore integrated in the system's safety concept.
- If it is to be used in a manner outside the scope of the safety concept, then corresponding measures must be taken.
- The installation work to be done by the customer must be carried out according to local regulations.
- It must be ensured, that all components are earthed according to the local regulations before start-up.



---

**For further security information, see the more detailed Gema safety regulations!**

---

### **WARNING**

#### **Working without instructions**

**Working without instructions or with individual pages from the instructions may result in damage to property and personal injury if relevant safety information is not observed.**

- ▶ Before working with the device, organize the required documents and read the section "Safety regulations".
  - ▶ Work should only be carried out in accordance with the instructions of the relevant documents.
  - ▶ Always work with the complete original document.
-



# Product description

---

## Intended use

The Application pump is intended for conveying coating powder (no enamel) to the powder gun.

The application pump operates only in combination with the OptiStar CG24-CP or CG12-CP (automatic equipment) or the OptiStar CG23-P or CG11-P Control unit (manual equipment).

The application pump will only operate in combination with the OptiGun GA03-P automatic gun or with other Gema models with a suitable diffuser (spraying air adapter). Please contact Gema if you have any further queries.

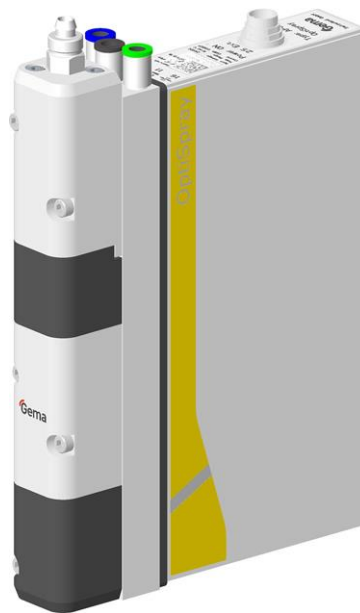

*fig. 1*

Observance of the operating, service and maintenance instructions specified by the manufacturer is also part of conformity of use. This product should only be used, maintained and started up by trained personnel, who are informed about and are familiar with the possible hazards involved.

Any other use is considered non-compliant. The manufacturer is not responsible for any incorrect use and the risks associated with such actions are assumed by the user alone!

For a better understanding of the interrelationships in powder coating, it is recommended that the operating instructions for all other components be read as well, so as to be familiar with their functions too.

---



## Reasonably foreseeable misuse

- Operation without the proper training
- Use with insufficient compressed air quality
- Input pressure too low
- Use in connection with unauthorized coating devices or components

---

## Technical Data

### Electrical data

OptiSpray AP01.1	
Nominal input voltage	24 VDC
Performance	10 VA
Protection type	IP54
Temperature range	+15 °C - +40 °C (+59 °F - +104 °F)
Temperature class	T6
Approvals	  II 3 D

### Pneumatic data

OptiSpray AP01.1	
Compressed air connection	Quick release connection - 8 mm
Inlet pressure	6 bar
Max. compressed air consumption	≈ 2.0 Nm <sup>3</sup> /h
Max. water vapor content of the compressed air	1.3 g/m <sup>3</sup>
Max. oil vapor content of the compressed air	0.1 mg/m <sup>3</sup>

## Powder output (reference values)

OptiSpray AP01.1	
<b>In OptiCenter:</b> Conveying hose till 20 m – internal Ø 7 mm Suction tube/hose till 30 cm – internal Ø 4,5 mm	50-300 g/min
<b>In manual equipment:</b> Conveying hose till 20 m – internal Ø 7 mm Suction hose max. 1.5 m – internal Ø 4,5 mm	50-300 g/min

## Dimensions

OptiSpray AP01.1	
Height (basic module, without connections)	275 mm
Width	40 mm
Depth	183 mm
Weight (basic module, without connections)	3.2 kg

## Sound pressure level

OptiSpray AP01.1	
Normal operation	< 60 dB(A)

The sound pressure level was measured while the unit was in operation; measurements were taken at the most frequent operator positions and at a height of 1.7 m from the ground.

The specified value is applicable only for this product itself and does not take into account external noise sources or cleaning impulses.

The sound pressure level may vary, depending on the product configuration and space constraints.

## Rating plate



fig. 2

## Design and function

### Overall view

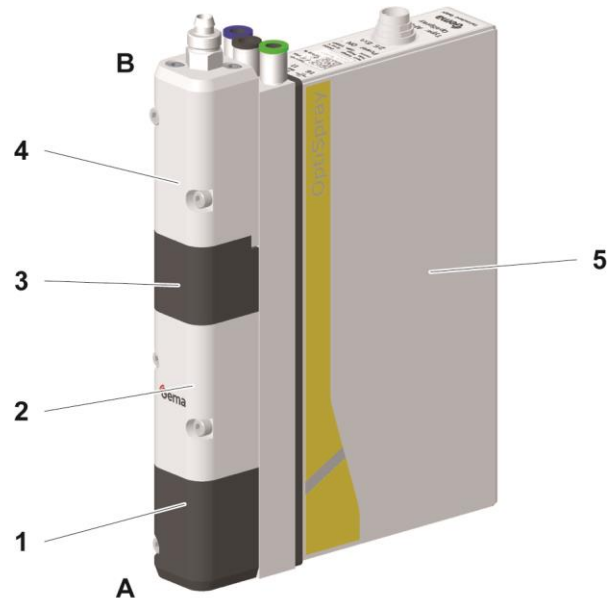

fig. 3

#### A Suction side

- 1 Pinch valve housing (suction side)
- 2 Filter element bodies with filter elements (suction side)

#### B Transport side

- 3 Pinch valve housing (transport side)
- 4 Filter element bodies with filter elements (transport side)
- 5 Pneumatic system and electronics

### Powder hoses

Depending the application, different powder hoses are used for the suction and conveying procedure. The corresponding hose connections with nuts with kink protection must be used!

Application	Suction side	Transport side
In OptiCenter OC03/OC05	Inside diameter 4.5 mm OptiCenter suction tube/hose max. 30 cm	Inside diameter 7 mm
In manual equipment OptiFlex 2 Spray	Inside diameter 4.5 mm, hose length max. 1.5 m	Inside diameter 7 mm

#### Other hose diameters can also be used for certain applications.

- Only use other hose diameters with the explicit recommendation of Gema!
- On the transport side, a powder hose with conductive strip must be used (electrically conductive)!

## Spraying air function / diffusers

The coating guns to be used must be equipped with the appropriate spraying air function or with an appropriate diffuser adapter.

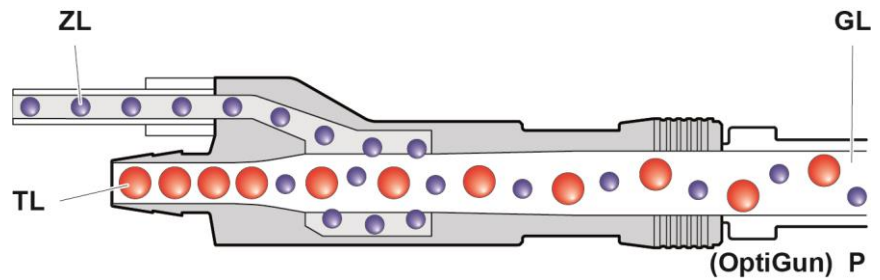

fig. 4: Air streams in the diffuser adapter

<b>GL</b>	Total air	<b>TL</b>	Transport air
<b>ZL</b>	Spraying air	<b>P</b>	Gun

The OptiGun GA02 automatic gun and the OptiSelect GM03 manual gun must also be equipped with an appropriate diffuser adapter.

The diffuser is grounded through the powder transport hose with conductive strips!

## Connections

### Compressed air hoses / cables



fig. 5: Connections – Compressed air hoses / cables

Connection	Description
1.1	Compressed air (Air Supply IN) connection
1.2	Transport air (Conveying Air IN) connection
1.6	Pinch valve air connection
2.5	External signal connection

### Pin assignment

#### Connection 2.5 Ext., 12-pins

A-H	Control signal
J-M	+24 VDC
	Body – grounding PE

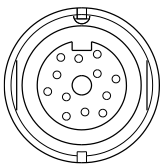

## Scope of delivery

- Mains cable
- Operating manual

## Typical properties - Characteristics of the functions

### Main functions

- Conveying coating powder from or a fluidized container to the powder gun
- Processing signals from the superordinated control unit

### Secondary functions

- Powder hose rinsing and cleaning of the filter elements

### Conveying direction

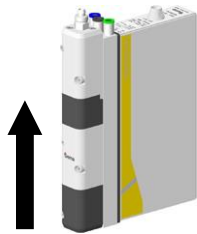

The Application pump conveying direction is defined by the direction of arrow, that means, the suction side is on the bottom, the transport side on the top (see picture).

### Powder hose rinsing

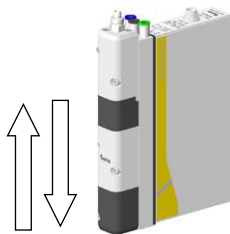

The powder hose rinsing enables the cleaning of the powder hoses and the filter elements in the Application pump. If color changes take place, rinsing must be done in conveying and in suction direction.

### Cleaning programs

The OptiStar Gun control unit features three cleaning programs:



- Powder chamber emptying combined with hose cleaning in both directions
- Cleaning the hose to the gun only
- Cleaning the hose on the suction side only

(For details, see the operating instructions of the corresponding gun control unit)



**ATTENTION****Large dust formation possible!**

- ▶ The conveying hose and the powder gun must be pointed into the booth during the cleaning procedure!

**The Ultra sonic sieve can be damaged during cleaning when being used with an OptiCenter.**

- ▶ Only the original lid (without any sieve insert) must be assembled and closed on the OptiSpeeder!

The pump is to be cleaned as a component of the entire system.

**Maintenance interval monitoring**

This function is provided by the superordinated control unit.



# Assembly / Connection

## Assembly guide

The application pump can be used in an OptiCenter OC03/OC05 Powder management center or as a part of the OptiFlex 2 Spray (B or F) manual equipment.



fig. 6

### ATTENTION

#### Surrounding temperature too high

- ▶ Install the Application pump only in locations with an ambient temperature of between +15 and +40 °C, i.e. never next to heat sources (such as an enameling furnace) or electromagnetic sources (such as a control cabinet).

## Connection instructions

The Gun control unit and the Application pump(s) are supplied ready for use by the manufacturer. Just a few cables and hoses must be connected.

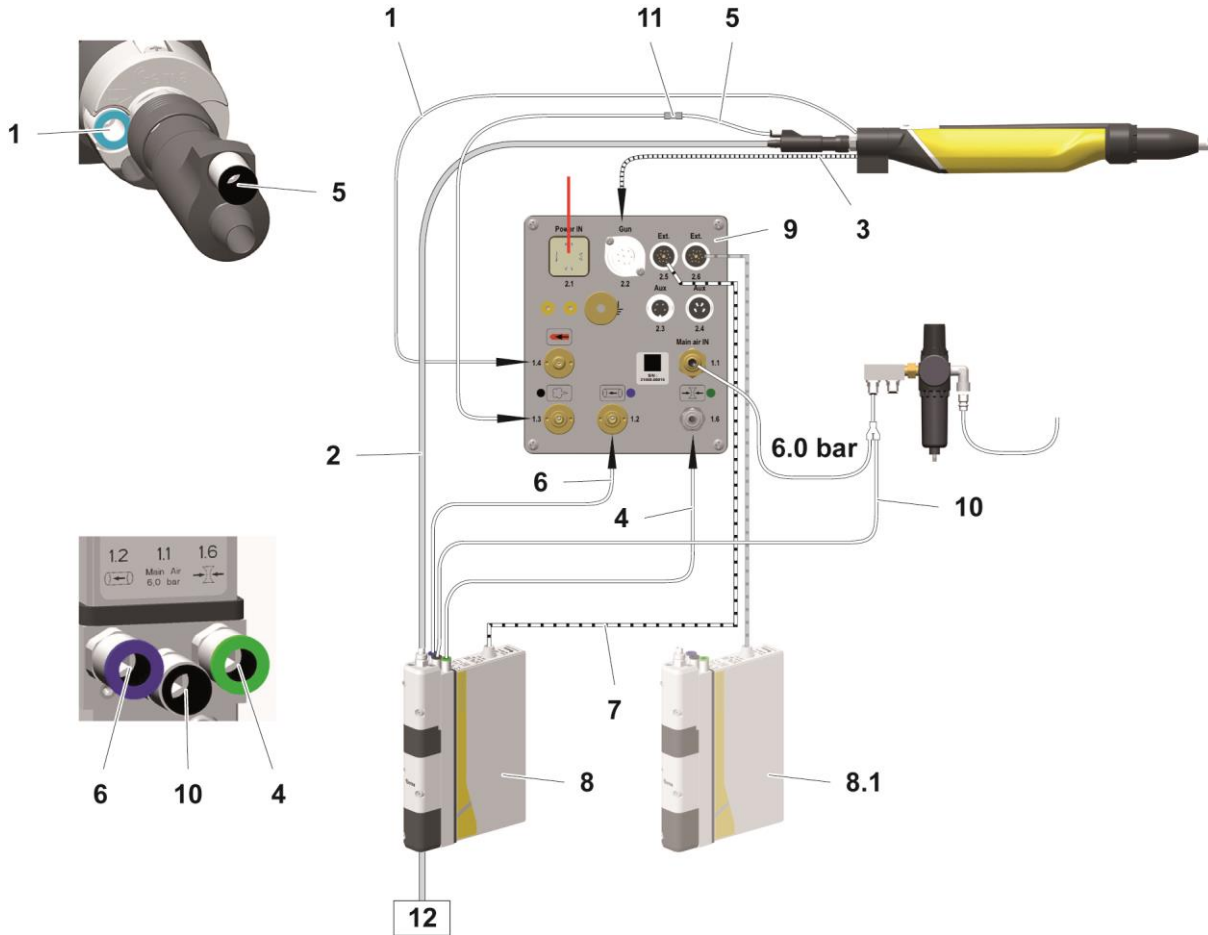

fig. 7: Connecting guide – overview

- |   |                            |     |                                   |
|---|----------------------------|-----|-----------------------------------|
| 1 | Electrode rinsing air hose | 8   | Application pump no. 1            |
| 2 | Powder hose                | 8.1 | Application pump no. 2            |
| 3 | Gun cable                  | 9   | Gun control                       |
| 4 | Pinch valve air            | 10  | Compressed air hose               |
| 5 | Spraying air hose          | 11  | Hose coupling Ø 8/6 –<br>Ø 6/4 mm |
| 6 | Transport air hose         | 12  | Powder hopper                     |
| 7 | Control signal cable       |     |                                   |



---

**Connect grounding cable to the booth or the suspension arrangement!**



- Check ground connections with Ohm meter and ensure 1 MOhm or less.



---

**The source electrical connections for the Control Units are to be connected in an unclassified location only.**



---

**The compressed air must be free of oil and water!**



---

**Close the unused connections with the provided dust protection caps!**

---





# Start-up

---

## Preparation for start-up

### Basic conditions

When starting up the Application pump, the following basic conditions, which have an influence on the powder transport, must be considered:

- Characteristic of hose layout
- Length and height difference of the suction distance: max. 30 cm
- Length of the conveying distance: 10-25 m
- Corresponding power and compressed air supply available
- Powder preparation and powder quality

### Basic information

The adherence of the following principles leads to a successful start-up of the Application pump:

- The suction distance is to be kept as short as possible
- Basically, the powder transport with the Application pump works with every powder type, which can be fluidized. If the powder is for example humid or contaminated with other materials, then the conveying can be negatively influenced or does not work at all
- At the suction area, a homogeneous fluidization must be ensured, so that no air ducts (craters) can be formed
- The Application pump is not intended for use with enamel powders





# Operation

---

## Operation



---

**During the initial commissioning of the device, the functional check must be performed without powder!**

---

### **Switching on and off the conveying procedure**

The conveying procedure is switched on and off by the pump control (see the corresponding operating manual).

### **Switching on and off the rinsing procedure**

The rinsing procedure is switched on and off by the pump control (see the corresponding operating manual).



---

**For a better understanding of the interrelationships in powder coating, it is recommended to read completely the operating instructions of the control unit and the powder gun, so as to be familiar with their functions too.**

---



# Maintenance / Repairs

## ATTENTION

**Any unauthorized modifications and alterations to the product are not permitted for safety reasons and exclude the manufacturer's liability for any resulting damage!**



**Regular, careful cleaning and maintenance extends the service life of the product and ensures long-lasting, uniform coating quality!**

- The parts to be replaced during maintenance work are available as spare parts. For further information, see chapter "Spare parts list".

---

## General information

The product is designed to require a minimum of maintenance.

---

## Maintenance of the dense phase pump

### Maintenance schedule

The following components or modules are subject to a maintenance plan:

- Pinch valves
- Filter elements

The service life of the filter elements and pinch valves depends on the service duration, the powder quality and the quality of the air supply.

### Daily maintenance

Clean the Application pump with a dry cloth and check the connection points of the powder hoses. Replace the powder hoses, if necessary.

Rinse the Application pump by using the rinsing program. Therewith, the filter elements are cleaned and possible, unintended powder deposits in the Application pump and in the powder hoses are avoided.

### Pinch valve diagnostic

The pinch valve diagnostic is to be carried out, in order to maintain the coating quality or after the error message **H89** is displayed.

The prerequisites for the diagnostic:

- Exhaust at suction and conveyance side must be present and in operation
- Powder hopper must be empty
- Cleaning program completed



---

#### **The pinch valve diagnostic is to start after the cleaning program has been completed!**

- The detailed procedure is explicitly described in the CG24-CP, CG23-P, CG12-CP or CG11-P Gun control unit operating instructions.
- 

If the error message **H87/H187** (suction pinch valve) or **H88/H188** (conveying pinch valve) is displayed after the procedure has been completed, the corresponding pinch valve hoses must be replaced – see below.

### Wear parts

The wear parts to be replaced during maintenance work are available separately.

---

## Cleaning

### Cleaning the Application pump (color change)

For the preparation of a color change, the pump has to be rinsed.



---

**The rinsing procedure can be started and stopped only externally via control unit or plant control.**

- The Application pump must be cleaned at least once per shift!
- 

---

## Periodic checks

The periodic checks include examining all connecting cables and hoses.

The corresponding parts should be replaced immediately if any damage to cables or hoses is discovered.

All plugs must be properly tightened.

## Repair work

In the event of malfunctions or faults, the product must be checked and repaired at an authorized Gema service location. The repairs must only be performed by an authorized specialist.

Improper interventions can result in serious danger for user or the equipment and may result in loss of warranty!

## Replacing the pinch valve hoses and filter elements



**Before dismantling/changing the filter elements, it is necessary to clean the Application pump in both directions by using the rinsing program!**

### Required spare parts

AP01.1 Service set / Gema order no. 1015 435

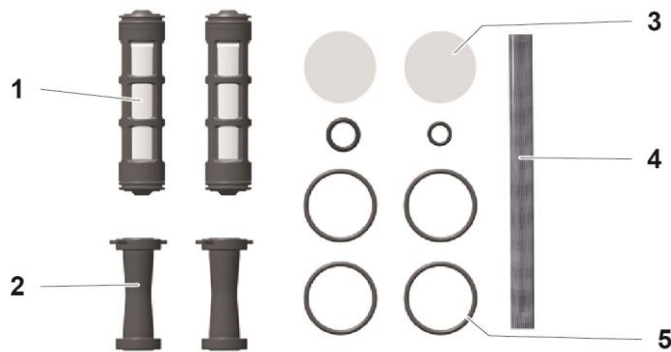

fig. 8

- |   |                  |   |                |
|---|------------------|---|----------------|
| 1 | Filter element   | 4 | Braided sleeve |
| 2 | Pinch valve hose | 5 | O-ring         |
| 3 | Protective disc  |   |                |

### Required Tools

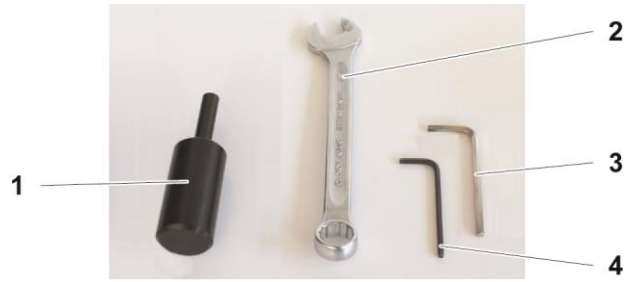
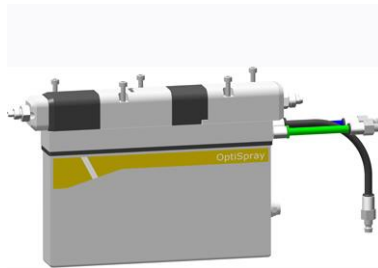

fig. 9

- 1 Dismantling tool  
(Order number: 1012 909)
- 2 Open-ended wrench 16 mm
- 3 Allen key size 4 mm
- 4 Allen key size 3 mm

### Pump disassembly

1.



2.

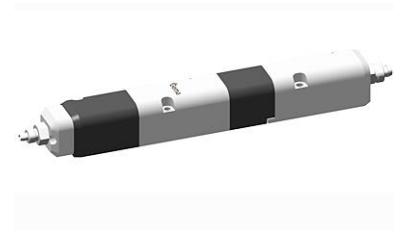

3.

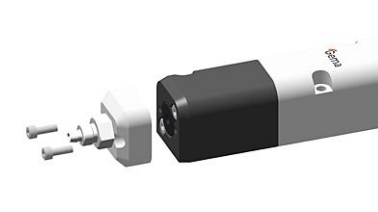

4.

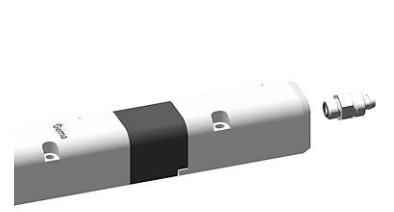

5.

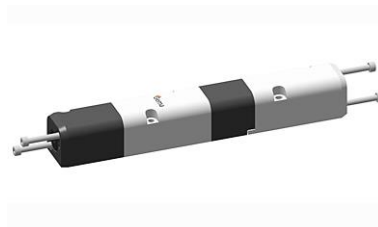

6.

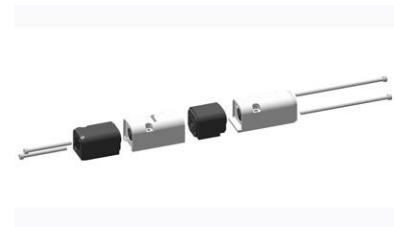

## Replacing the pinch valve hoses

1.



2.

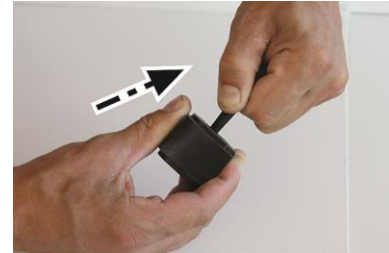

3.



4.



5.



### ATTENTION

#### Incorrect inserted pinch valve hose causes malfunctions

- ▶ It is imperative to consider the position of the lens-shaped opening!
- ▶ Make sure that the positioning tabs are set correctly!

6.

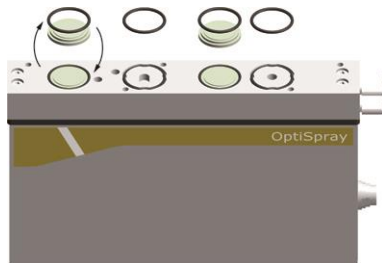

### ATTENTION

#### Broken pinch valve hose may cause the clogging of the protective disc

- ▶ Clean or replace the corresponding protective disc!



## Replacing the filter elements

### ATTENTION

Use of non-permissible cleaning agents may cause damage to the plastic pinch valve body

- ▶ When cleaning the pinch valve bodies, do not use alcohol, acetone, benzol or other solvents!
- ▶ For cleaning, use benzine, light lye or acid or a cleaning agent!

1.

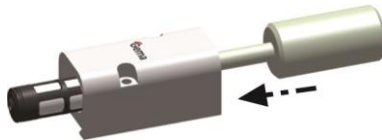

2.

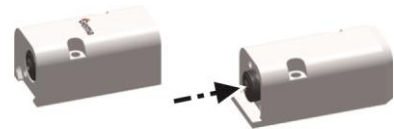

### ATTENTION

Incorrectly assembled parts may cause malfunctions or defects

- ▶ The assembly takes place in reverse order!
- ▶ The tightening torques are to be observed, when assembling!
- ▶ The process zone has to be pressed against a planar surface and assembled on it!

3.

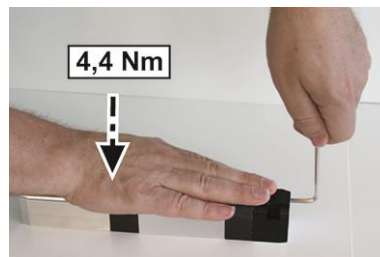

4.

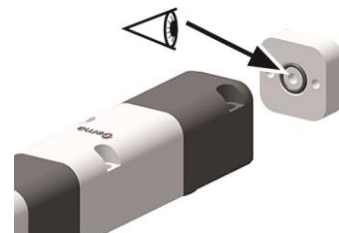

5.

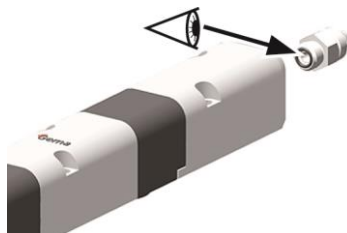

6.

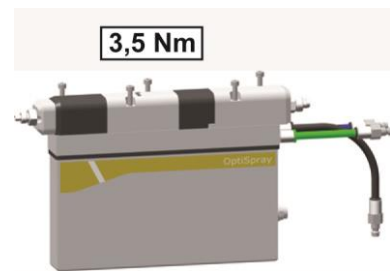

After installing new filter elements, an increased powder output is to be expected for a short time.

# Replacing the solenoid valves for pinch valves control

## Requirements on personnel carrying out the work

All work should be carried out only by authorized technical personnel.



**Before dismantling/changing the solenoid valves, it is necessary to clean the Application pump in both directions by using the rinsing program!**

## Required Tools

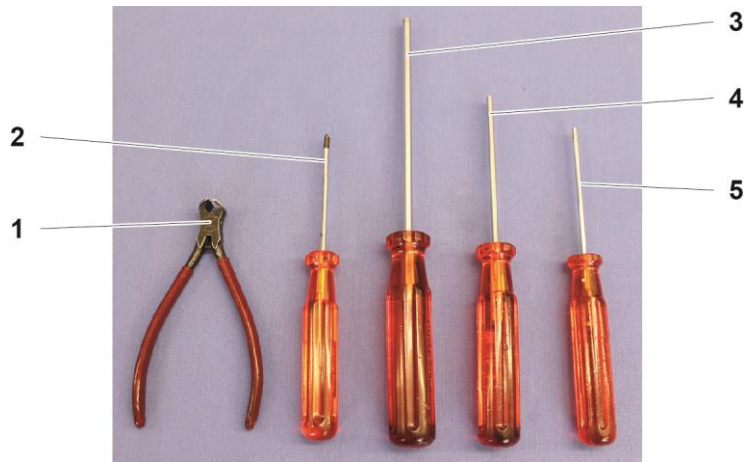

fig. 10

- |                            |                              |
|----------------------------|------------------------------|
| 1 Side cutter              | 4 Hexagon screwdriver 3 mm   |
| 2 Phillips screwdriver PH0 | 5 Hexagon screwdriver 2.5 mm |
| 3 Hexagon screwdriver 4 mm |                              |

## Required spare parts

AP01 Solenoid valve		Gema order no.
V1	Suction pinch valve	1009 936
V2	Conveying pinch valve	1009 936

## Replacing the solenoid valves



1.



2.

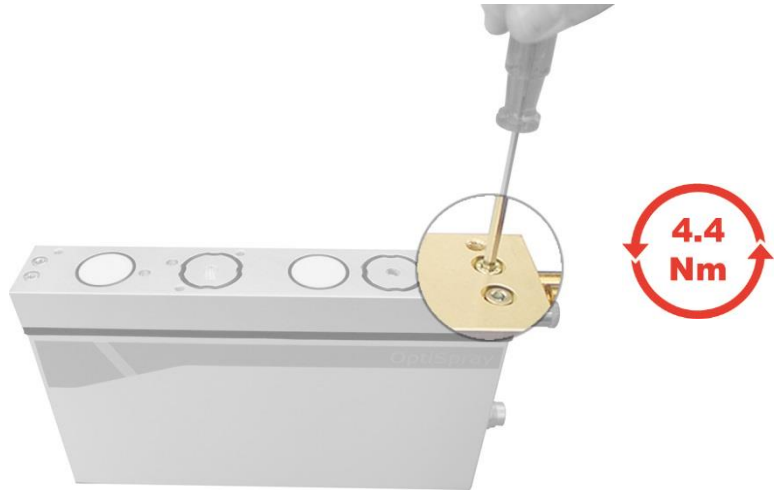

3.



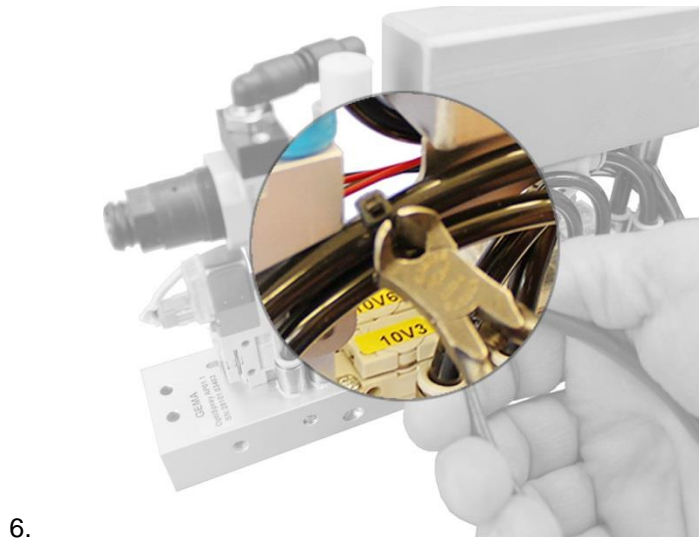
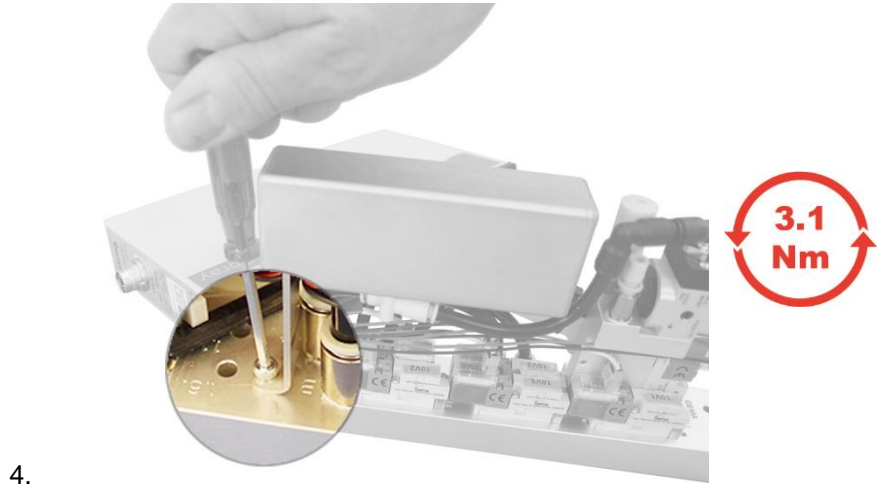

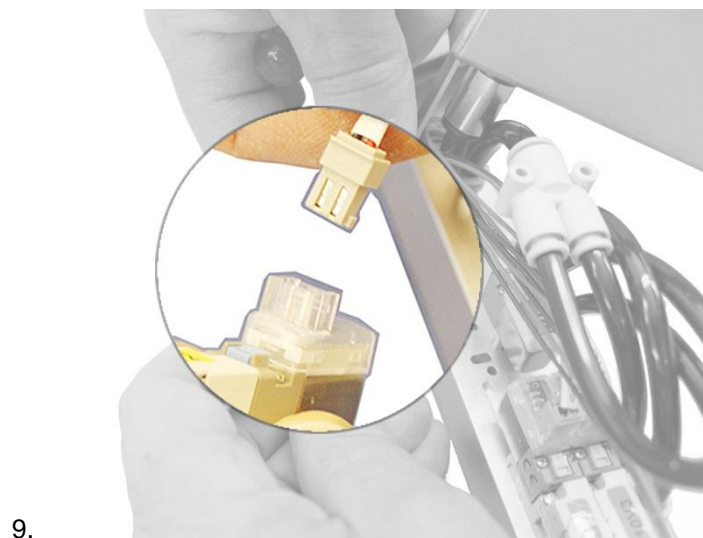
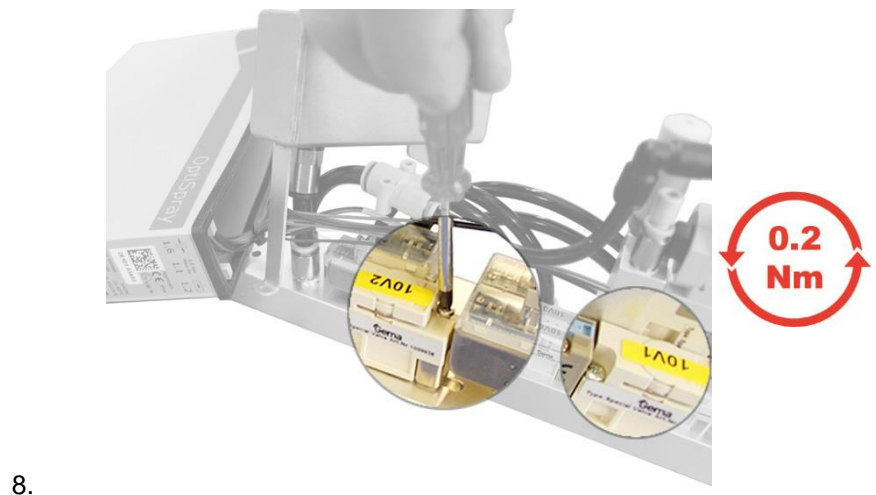
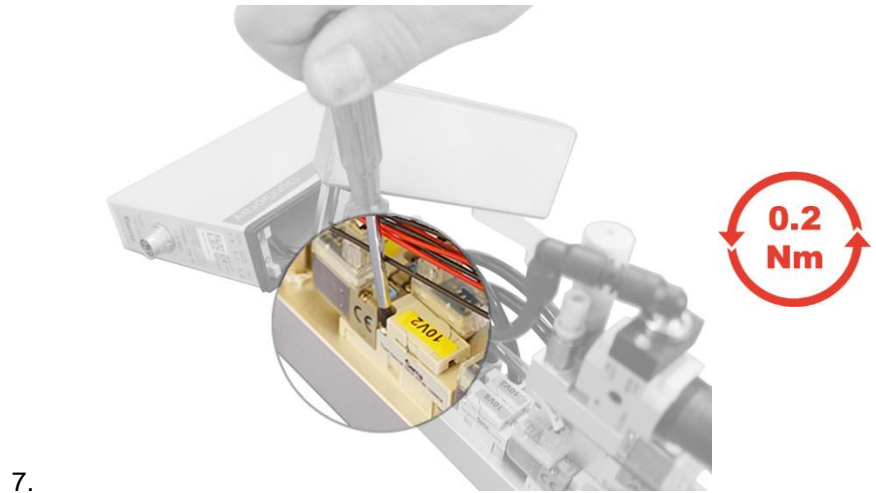

**The assembly takes place in reverse order!**

## **Replacing the Application pump in an OptiCenter**

1. Remove the powder from the system
2. Start the cleaning program, rinse in both directions
3. Depressurize/vent OptiCenter
4. Next steps are described in the corresponding OptiCenters operating manual

# Fault clearance



**Prior to any troubleshooting measures, always check the parameters configured in the control unit!**

- ▶ See operating manual OptiStar CG24-CP, CG23-P, CG12-CP or CG11-P!

Incident	Causes	Corrective action
<b>Application pump does not convey</b>	No control signal	Check the control cable
	Compressed air supply failed or pressure too low	Check the compressed air source (ensure an air pressure of 7-10 bar), check the pressure gauge of the local pressure regulator
	No transport air present	Check the hose connection of the control unit to the Application pump Check the compressed air supply
	No fluidization in the suction zone	Ensure the fluidization
	Service life of the pinch valve has expired (defective)	Change the pinch valve, check the pneumatic system for defects and replace, if necessary
	Service life of the filter element runs off (clogged)	Replace the filter element
<b>Application pump conveys irregularly or too little powder</b>	Pinholing in the powder container, powder will not be fluidized well	Adjust the fluidization correctly
	Hose backpressure is larger than 1.2 bar	Powder hose is too long or too thin Powder hose is clogged or bend (clean or replace it) Filter elements (filter chamber/pinch valve hose) are clogged (clean or replace them)
	Filter elements tend to clogging	Run the rinsing program, replace the filter elements
	Powder hoses tend to clogging due to sintering	Clean or replace the powder hoses
	Oil or water in the system	Ensure that oil or water will be separated before entering into the Application pump

Incident	Causes	Corrective action
	Transport air offset C3 not adapted to powder output	Adapt transport air offset C3 (see operating manual OptiStar CG24-CP, CG23-P, CG12-CP oder CG11-P, section "Correction values")







# Decommissioning / Storage

---

## Shutdown

1. End the coating procedure
2. Switch off the control unit



---

**The adjustments for high voltage, powder output volume and electrode rinsing air remain stored.**

---

### If in disuse for several days

1. Switch off the plant with the main switch
2. Clean the gun and the components for powder conveying (see therefore the corresponding user manuals)
3. Turn off the compressed air main supply

---

## Storage conditions

### Hazard notes

There is no danger to personnel or the environment if the unit is stored properly.

### Type of storage

For safety reasons, the product should only be stored in a horizontal position

### Storage duration

If the physical conditions are maintained, the unit can be stored indefinitely.

### Space requirements

The space requirements correspond to the size of the product.

There are no special requirements concerning distance to neighboring equipment.

## **Physical requirements**

Storage must be inside a dry building at a temperature between +5 and +50 °C. Do not expose to direct sunlight!

---

## **Maintenance during storage**

### **Maintenance schedule**

No maintenance schedule is necessary.

### **Maintenance works**

During long-term storage, periodically perform a visual check.

# Disposal

---

## Introduction

### Requirements on personnel carrying out the work

The disposal of the product is to be carried out by the owner or operator. When disposing of components that are not manufactured by Gema, the instructions in the respective manufacturer's documentation must be observed.

### Disposal regulations



---

**The product must be disassembled and disposed of properly at the end of its service life.**

- ▶ When disposing of the product, the applicable local and regional laws, directives and environmental regulations must be complied with!
- 

### Materials

The materials must be sorted according to material groups and taken to the appropriate collection points.

---

## Disassembly of component groups

### WARNING

#### Live components

#### Risk of fatal injury from electric shock if touched

- ▶ Only trained, authorized staff may open the electrical compartment
  - ▶ Observe the safety symbols
- 

1. Disconnect the mains supply and supply cables.
2. Remove all product covers.

The product is now prepared for disassembly.



# Spare parts list

---

## Ordering spare parts

When ordering spare parts for your product, please indicate the following specifications:

- Type and serial number of your product
- Order number, quantity and description of each spare part

**Example:**

- **Type** Application pump OptiSpray AP01.1  
Serial number 1234 5678
- **Order no.** 203 386, 1 piece, Clamp – Ø 18/15 mm

When ordering cable or hose material, the required length must also be given. The spare part numbers of this bulk stock is always marked with an \*.

The wearing parts are always marked with a #. marked.

All dimensions of plastic hoses are specified with the external and internal diameter:

**Example:**

Ø 8/6 mm, 8 mm outside diameter (o/d) / 6 mm inside diameter (i/d)

 **WARNING**

**Use of non-original Gema spare parts**

**When using the spare parts from other manufacturers the explosion protection is no longer guaranteed. If any damage is caused by this use all warranty claims become invalid!**

- ▶ Only original Gema spare parts should be used!
-

## OptiSpray AP01.1 Application pump

	OptiSpray AP01.1 Application pump – complete (pos. 1-14, 26-27)	1015 447
1	Allen cylinder screw – M5x130 mm	1010 431
2	Upper end piece	1010 428
3	Filter element – 3 µm, complete	1014 060#
4	Allen cylinder screw – M5x35 mm	1005 185
5	Filter element body	1010 046
6	Pinch valve hose	1017 438#
6.1	Braided sleeve – fit-up aid kit for pos. 6 (not shown)	1005 270
7	Allen cylinder screw – M5x65 mm	244 759
8	Bushing	1010 433
9	Upper pinch valve housing	1010 429
10	Lower pinch valve housing	1010 432
11	Protective disc	1010 354#
12	O-ring – Ø 26x2 mm	246 549#
13	Valves assembly – complete (without pos. 14)	1010 305
14	Body – complete (for pos. 13)	1015 456
15	Nut with kink protection – M16x1-Ø 12 mm	1005 443
16	Elbow connection	1010 051
17	Allen cylinder screw – M5x20 mm	222 950
18	Allen cylinder screw – M4x12 mm	216 275
19	O-ring – Ø 10x2 mm	243 000#
20	Plug	1010 052
21	O-ring – Ø 16x2 mm	1007 794#
22	Suction tube	1010 053
23	O-ring – Ø 6x1 mm	217 115#
24	Connection/plug	200 859
25	Screw-in nipple – 1/8"-Ø 8 mm	1010 378
26	Hose connection – Ø 11.5/7 mm	1019 542
27	O-Ring – Ø 7x1.5 mm	1013 549#
30	Powder hose suction side – Ø 4.5 mm (not shown)	1005 454*
31	Powder hose transport side – Ø 11.5/7 mm (not shown)	1005 097*
32	Plastic tube – Ø 8/6 mm, blue	103 497*
33	Plastic tube – Ø 8/6 mm, black	103 152*
34	Plastic tube – Ø 8/6 mm, green	103 519*
40	Hose connection – Ø 8.1/4.5 mm	1010 372
41	O-ring – Ø 8x1.5 mm	248 878#
42	Adaptor	1010 370
43	Nut with kink protection – M12x1-Ø 8 mm	201 316
44	Maintenance set – pos. 3 (2x), 6 (2x), 6.1 (1x), 11 (2x), 12 (4x), 19 (1x), 27 (1x)	1015 435

\* Please indicate length

# Wearing part



# OptiSpray AP01.1 – spare parts

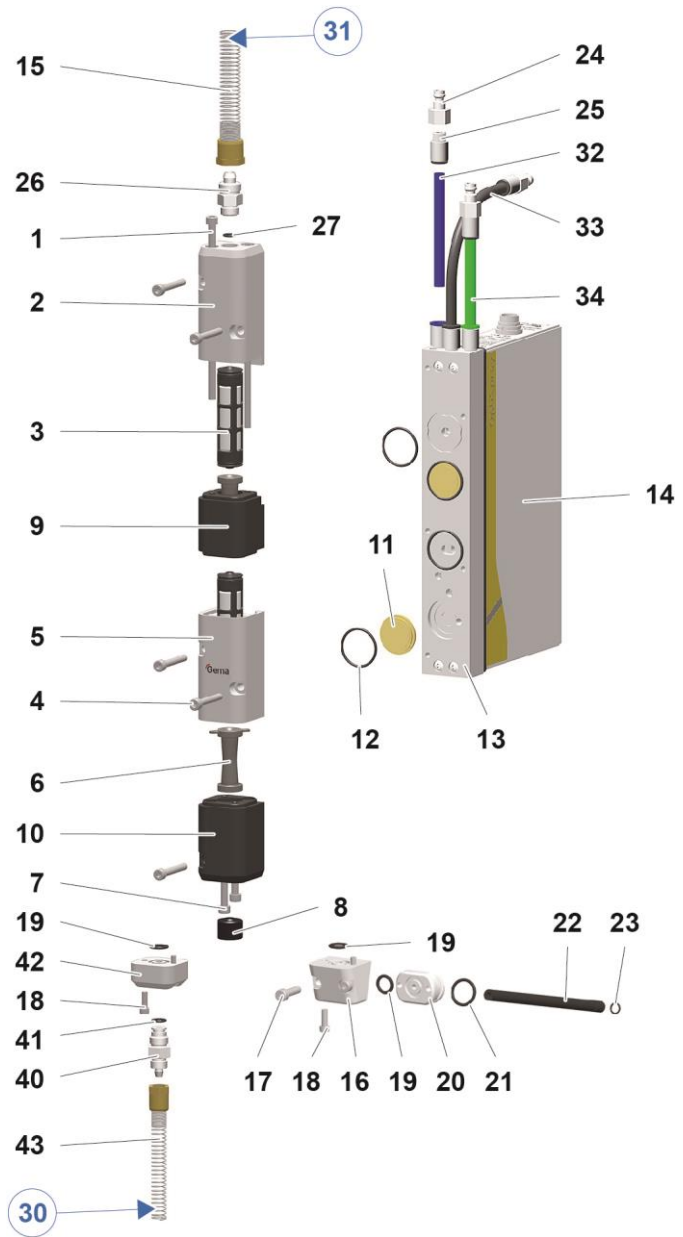

fig. 11

Item	Tightening torque [Nm]
1	4.4 (greased)
4	3.1 (greased)
7	4.4 (greased)
17	3.1
18	0.5

## OptiSpray Twin AP01.1 Application pump

	OptiSpray Twin AP01.1 Application pump – complete (pos. 1-14, 26-28)	1019 707
1	Allen cylinder screw – M5x130 mm	1010 431
2	Upper end piece	1019 712
3	Filter element – 3 µm, complete	1014 060#
4	Allen cylinder screw – M5x35 mm	1005 185
5	Filter element body	1010 046
6	Pinch valve hose	1017 438#
6.1	Braided sleeve – fit-up aid kit for pos. 6 (not shown)	1005 270
7	Allen cylinder screw – M5x65 mm	244 759
8	Bushing	1010 433
9	Upper pinch valve housing	1010 429
10	Lower pinch valve housing	1010 432
11	Protective disc	1010 354#
12	O-ring – Ø 26x2 mm	246 549#
13	Valves assembly – complete (without pos. 14)	1010 305
14	Body – complete (for pos. 13)	1015 456
15	Nut with kink protection – M16x1-Ø 12 mm	1005 443
16	Elbow connection	1010 051
17	Allen cylinder screw – M5x20 mm	222 950
18	Allen cylinder screw – M4x12 mm	216 275
19	O-ring – Ø 10x2 mm	243 000#
20	Plug	1010 052
21	O-ring – Ø 16x2 mm	1007 794#
22	Suction tube	1010 053
23	O-ring – Ø 6x1 mm	217 115#
24	Connection/plug	200 859
25	Screw-in nipple – 1/8"-Ø 8 mm	1010 378
26	Hose connection – Ø 11.5/7 mm	1019 542
27	O-Ring – Ø 7x1.5 mm	1013 549#
28	Dummy filter element – complete	1014 587#
30	Powder hose suction side – Ø 4.5 mm (not shown)	1005 454*
31	Powder hose transport side – Ø 11.5/7 mm (not shown)	1005 097*
32	Plastic tube – Ø 8/6 mm, blue	103 497*
33	Plastic tube – Ø 8/6 mm, black	103 152*
34	Plastic tube – Ø 8/6 mm, green	103 519*
40	Hose connection – Ø 8.1/4.5 mm	1010 372
41	O-ring – Ø 8x1.5 mm	248 878#
42	Adaptor	1010 370
43	Nut with kink protection – M12x1-Ø 8 mm	201 316
44	Maintenance set – pos. 3 (2x), 6 (2x), 6.1 (1x), 11 (2x), 12 (4x), 19 (1x), 27 (1x)	1015 435

\* Please indicate length

# Wearing part

# OptiSpray Twin AP01.1 – spare parts

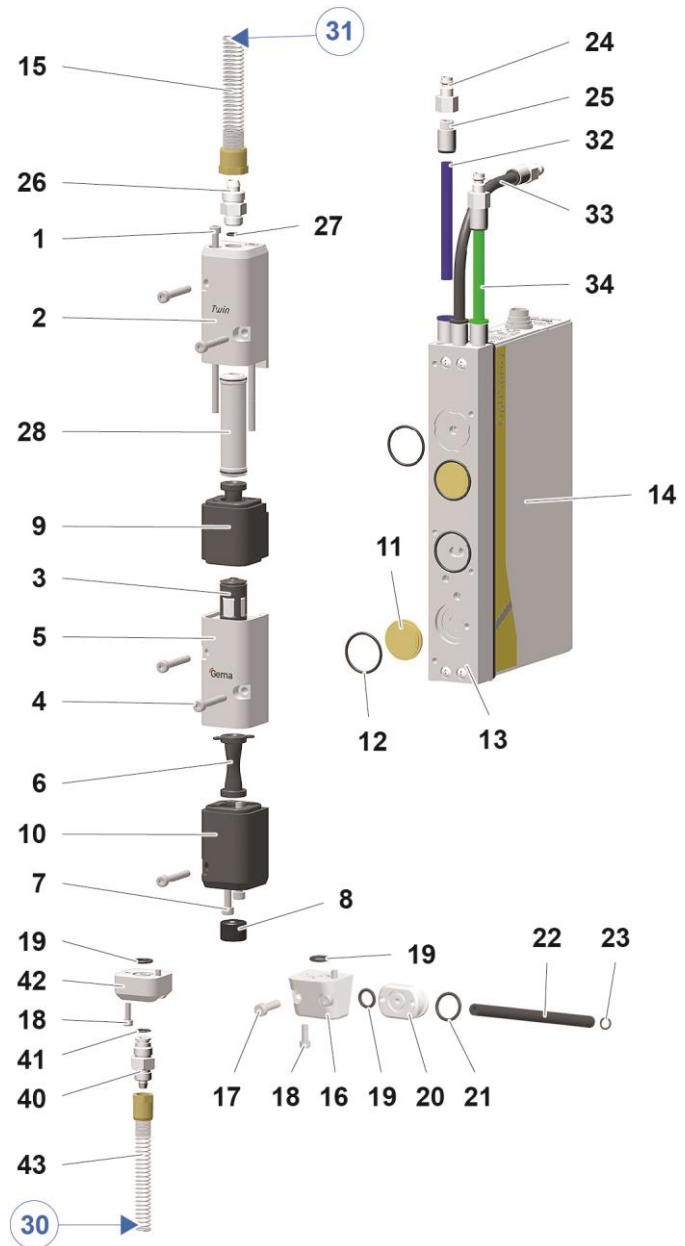

fig. 12

Item	Tightening torque [Nm]
1	4.4 (greased)
4	3.1 (greased)
7	4.4 (greased)
17	3.1
18	0.5

## Connecting material

1.1	Plastic tube – Ø 8/6 mm, black	103 152*
1.2	Plastic tube – Ø 8/6 mm, blue	103 497*
1.6	Plastic tube – Ø 8/6 mm, green	103 519*
2.5	Connecting cable – 12 pins, 1.5 m	1000 991
	Connecting cable – 12 pins, 2.2 m	393 398
	Connecting cable – 12 pins, 5 m	1000 975
	Connecting cable – 12 pins, 10 m	1000 976
	Connecting cable – 12 pins, 15 m	1000 977
	Connecting cable – 12 pins, 20 m	1000 978

\* Please indicate length

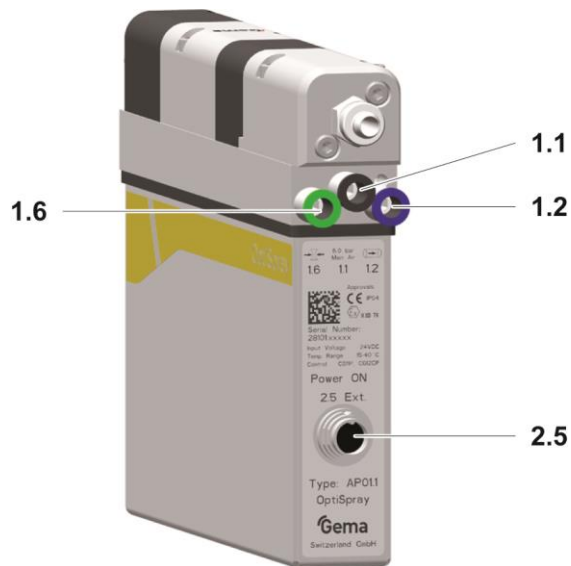

fig. 13: Connecting material

# Index

## A

About these instructions.....	5
Assembly.....	19
Assembly guide.....	19

## B

Basic safety instructions.....	7
--------------------------------	---

## C

Cleaning.....	29
Cleaning programs.....	16
Color change.....	29
Compressed air hoses / cables.....	15
Connecting material.....	52
Connection.....	19
Connection instructions.....	20
Connections.....	15
Conveying direction.....	16

## D

Daily maintenance.....	28
Decommissioning.....	43
Design and function.....	13
Dimensions.....	11
Disassembly of component groups.....	45
Disposal.....	45
Disposal regulations.....	45
Disuse for several days.....	43

## E

Electrical data.....	10
----------------------	----

## F

Fault clearance.....	39
Figure references in the text.....	6

## I

Intended use.....	9
-------------------	---

## M

Main functions.....	16
Maintenance.....	27
Maintenance during storage.....	44
Maintenance interval monitoring.....	17

Maintenance of the dense phase pump.....	28
Maintenance schedule.....	28

## O

Operation.....	25
Overall view.....	13

## P

Periodic checks.....	29
Pictograms.....	5
Pin assignment.....	15
Pinch valve diagnostic.....	28
Pneumatic data.....	10
Powder hose rinsing.....	16
Powder hoses.....	13
Powder output (reference values).....	11
Preparation for start-up.....	23
Presentation of the contents.....	6
Product description.....	9
Product specific security regulations.....	8
Pump disassembly.....	31

## R

Rating plate.....	12
Reasonably foreseeable misuse.....	10
Repair work.....	30
Repairs.....	27
Replacing	
Filter elements.....	30
Filter elements.....	33
Pinch valve hoses.....	30, 32
Solenoid valves.....	34, 35
Replacing the Application pump in an OptiCenter.....	38
Required spare parts.....	30, 34
Required Tools.....	31, 34

## S

Safety.....	7
Safety symbols.....	5
Scope of delivery.....	15
Secondary functions.....	16
Shutdown.....	43
Sound pressure level.....	11
Spare parts list.....	47
Spraying air function / diffusers.....	14
Start-up.....	23

Storage .....	43
Storage conditions .....	43
Switching on and off	
Conveying procedure .....	25
Rinsing procedure .....	25

**T**

Technical Data .....	10
Typical characteristics .....	16

**W**

Wear parts .....	28
------------------	----



