

---

Quick reference guide

# Manual equipment OptiFlex Pro W



Detailed information and detailed spare parts lists can be found in the corresponding operating instructions: via the Gema app or [www.gemapowdercoating.com/en/support/operation-manuals](http://www.gemapowdercoating.com/en/support/operation-manuals).



Translation of the original operating instructions

## Documentation OptiFlex Pro W

© Copyright 2019 Gema Switzerland GmbH

All rights reserved.

This publication is protected by copyright. Unauthorized copying is prohibited by law. No part of this publication may be reproduced, photocopied, translated, stored on a retrieval system or transmitted in any form or by any means for any purpose, neither as a whole nor partially, without the express written consent of Gema Switzerland GmbH.

Gema, EquiFlow, MagicCompact, MagicCylinder, OptiCenter, OptiFlex, OptiGun, OptiSelect and OptiStar are registered trademarks of Gema Switzerland GmbH.

ClassicLine, ClassicStandard, ClassicOpen, DVC (Digital Valve Control), GemaConnect, MagicControl, MagicPlus, MonoCyclone, MRS, MultiColor, MultiStar, OptiAir, OptiControl, OptiColor, OptiFeed, OptiFlow, OptiHopper, OptiMove, OptiSieve, OptiSpeeder, OptiSpray, PCC (Precise Charge Control), RobotGun, SIT (Smart Inline Technology) and SuperCorona are trademarks of Gema Switzerland GmbH.

All other product names are trademarks or registered trademarks of their respective holders.

Reference is made in this manual to different trademarks or registered trademarks. Such references do not mean that the manufacturers concerned approve of or are bound in any form by this manual. We have endeavored to retain the preferred spelling of the trademarks, and registered trademarks of the copyright holders.

To the best of our knowledge and belief, the information contained in this publication was correct and valid on the date of publication. Gema Switzerland GmbH makes no representations or warranties with respect to the contents or use of this publication, and reserves the right to revise this publication and make changes to its content without prior notice.

For the latest information about Gema products, visit [www.gemapowdercoating.com](http://www.gemapowdercoating.com).

For patent information, see [www.gemapowdercoating.com/patents](http://www.gemapowdercoating.com/patents) or [www.gemapowdercoating.us/patents](http://www.gemapowdercoating.us/patents).

### Printed in Switzerland

Gema Switzerland GmbH  
Mövenstrasse 17  
9015 St.Gallen  
Switzerland

Phone: +41-71-313 83 00

Fax.: +41-71-313 83 83

E-mail: [info@gema.eu.com](mailto:info@gema.eu.com)

# Table of contents

<b>About these instructions</b>	<b>5</b>
General information .....	5
Keeping the Manual .....	5
Safety symbols (pictograms).....	5
Presentation of the contents .....	6
<b>Safety</b>	<b>7</b>
General information .....	7
Basic safety instructions .....	7
Product specific security regulations .....	8
<b>OptiFlex Pro W</b>	<b>13</b>
Intended use .....	13
Structure.....	14
Scope of delivery .....	15
Typical characteristics – properties of the functions.....	15
Technical Data .....	17
<b>Assembly / Connection</b>	<b>21</b>
Connection instructions.....	21
<b>Start-up</b>	<b>23</b>
Initial start-up.....	23
Setting the device type.....	24
<b>Operation</b>	<b>25</b>
Operation .....	25
Rinsing mode .....	30
Color change.....	33
<b>Decommissioning / Storage</b>	<b>35</b>
Decommissioning.....	35
<b>Maintenance / Repairs</b>	<b>37</b>
General information .....	37
Interval .....	37
Cleaning.....	39
<b>Fault clearance</b>	<b>41</b>
<b>OptiStar CG21</b>	<b>43</b>
Design and function .....	43

<b>Fault clearance</b>	<b>47</b>
Error diagnosis of the software.....	47
<b>OptiSelect Pro GM04</b>	<b>51</b>
Structure .....	51
Available accessories** .....	52
Technical Data.....	53
<b>Fault clearance</b>	<b>55</b>
<b>OptiFlow IG07</b>	<b>57</b>
Structure .....	57
Powder volume setting for OptiFlow Injector.....	58
<b>Maintenance / Repairs</b>	<b>59</b>
Cleaning.....	59
Cleaning the injector.....	59
Cleaning the check valve units.....	60
Changing the cartridge .....	61
<b>Fault clearance</b>	<b>63</b>
Faults .....	63
<b>Spare parts list</b>	<b>65</b>
Ordering spare parts.....	65
OptiFlex Pro W – Spare parts list .....	66
OptiFlex Pro W – Spare parts.....	67
Pneumatic group .....	68
PowerClean module set** .....	69
OptiStar CG21 Gun control unit.....	70
Front plate and power pack .....	71
Inside back plate.....	72
Inside back plate.....	73
Connecting material.....	74
Connecting material.....	75
OptiSelect Pro GM04 – spare parts list .....	76
PowerClean™ module (Option).....	78
SuperCorona .....	79
Accessories .....	80
OptiFlow IG07 – Spare parts list.....	85
OptiFlow IG07 – spare parts.....	86

# About these instructions

---

## General information

This operating manual contains all important information which you require for the working with the OptiFlex Pro W. It will safely guide you through the start-up process and give you references and tips for the optimal use when working with your powder coating system.

Information about the functional mode of the individual system components should be referenced in the respective enclosed documents.



**This operating manual describes all options and functions of this manual coating equipment.**

- Please note that your manual coating equipment may not be equipped with all described functions.
- Options are marked by double asterisks\*\*.

---

## Keeping the Manual

Please keep this Manual ready for later use or if there should be any queries.

---

## Safety symbols (pictograms)

The following warnings with their meanings can be found in the Gema instructions. The general safety precautions must also be followed as well as the regulations in the relevant instructions.

### DANGER

Indicates a hazardous situation which, if not avoided, will result in death or serious injury.

### WARNING

Indicates a hazardous situation which, if not avoided, could result in death or serious injury.

**⚠ CAUTION**

Indicates a hazardous situation which, if not avoided, could result in minor or moderate injury.

**ATTENTION**

Indicates a potentially harmful situation. If not avoided, the equipment or something in its surrounding may be damaged.

**ENVIRONMENT**

Indicates a potentially harmful situation which, if not avoided, may have harmful consequences for the environment.



**MANDATORY NOTE**

Information which must be observed.



**NOTICE**

Useful information, tips, etc.

**Structure of Safety Notes**

Every note consists of 4 elements:

- Signal word
- Nature and source of the danger
- Possible consequences of the danger
- Prevention of the danger

**⚠ SIGNAL WORD**

**Nature and source of the hazard!**

**Possible consequences of the danger**

- ▶ Prevention of the danger

**Presentation of the contents**

**Figure references in the text**

Figure references are used as cross references in the descriptive text.

**Example:**

"The high voltage (**H**) created in the gun cascade is guided through the center electrode."

# Safety

---

## General information

This chapter provides the user and third parties who operate this product with all essential safety regulations, the adherence to which is imperative.

These safety regulations must be read and understood in their entirety before the product is put into operation.

The standards and guidelines applied during the development, manufacture and configuration are described in the EC declaration of conformity and in the manufacturer's declaration.

### **WARNING**

#### **Working without instructions**

**Working without instructions or with individual pages from the instructions may result in damage to property and personal injury if relevant safety information is not observed.**

- ▶ Before working with the device, organize the required documents and read the section "Safety regulations".
  - ▶ Work should only be carried out in accordance with the instructions of the relevant documents.
  - ▶ Always work with the complete original document.
- 

---

## Basic safety instructions

- This product is built to the latest specification and conforms to the recognized technical safety regulations and is designed for the normal application of powder coating.
- Any other use is considered non-compliant. The manufacturer shall not be liable for damage resulting from such use; the user bears sole responsibility for such actions. If this product is to be used for other purposes or other substances outside of our guidelines then Gema Switzerland GmbH should be consulted.
- Start-up (i.e. the execution of intended operational tasks) is forbidden until it has been established that this product has been set up and wired according to the guidelines for machinery. The standard "Machine safety" must also be observed.
- Unauthorized modifications to the product exempt the manufacturer from any liability from resulting damage.

- The relevant accident prevention regulations, as well as other generally recognized safety regulations, occupational health and structural regulations are to be observed.
- Furthermore, the country-specific safety regulations also must be observed.

## Product specific security regulations

- This product is a constituent part of the equipment and is therefore integrated in the system's safety concept.
- If it is to be used in a manner outside the scope of the safety concept, then corresponding measures must be taken.
- The installation work to be done by the customer must be carried out according to local regulations.
- It must be ensured, that all components are earthed according to the local regulations before start-up.



**For further security information, see the more detailed Gema safety regulations!**

### **WARNING**

**These general safety regulations must be read and understood in all cases prior to start-up!**



### **General information**

This product is built to the latest specification and conforms to the recognized technical safety regulations and is designed for the normal application of powder coating.

Any other use is considered non-compliant. The manufacturer shall not be liable for damage resulting from such use; the user bears sole responsibility for such actions. If this product is to be used for other purposes or other substances outside of our guidelines then Gema Switzerland GmbH should be consulted.

Observance of the operating, service and maintenance instructions specified by the manufacturer is also part of conformity of use.

The relevant accident prevention regulations, as well as other generally recognized safety regulations, occupational health and structural regulations are to be observed.

Furthermore, the country-specific safety regulations also must be observed.

Additional safety and operation notices can be found on the accompanying CD or on the homepage [www.gemapowdercoating.com](http://www.gemapowdercoating.com).





### **General dangers**

Start-up is forbidden until it has been established that the product has been set up and wired according to the EU guidelines for machinery.

Unauthorized modifications to the product exempt the manufacturer from any liability from resulting damages or accidents.

The operator must ensure that all users do have the appropriate training for powder spraying equipment and are aware of the possible sources of danger.

Any operating method, which will negatively influence the technical safety of the powder spraying equipment, is to be avoided.

For your own safety, only use accessories and attachments listed in the operating instructions. The use of other parts can lead to risk of injury. Only original Gema spare parts should be used!

Repairs must only be carried out by specialists or by authorized Gema service centers. Unauthorized conversions and modifications can lead to injuries and damage to the equipment and invalidate the Gema Switzerland GmbH guarantee.



### **Electrical danger**

The connecting cables between the control unit and the spray gun must be installed in such a way, that they cannot be damaged during the operation. Please observe the local safety regulations!

The plug connections between the powder spraying equipment and the mains should only be removed when the power supply is switched off.

All maintenance activities must take place when the powder spraying equipment is switched off.

The product may not be switched on until the booth is in operation. If the booth stops, the product must switch off too.



### **Explosion hazard**

The control units for the spray guns must be installed and used in zone 22. Spray guns are allowed in zone 21.

Only original Gema OEM parts are guaranteed to maintain the explosion protection rating. If damages occur by using spare parts from other manufacturers, the warranty or compensation claim is void!

Conditions leading to dangerous levels of dust concentration in the powder spraying booths or in the powder spraying areas must be avoided. There must be sufficient technical ventilation available, to prevent a dust concentration of more than 50% of the lower explosion limit (UEG = max. permissible powder/air concentration). If the UEG is not known, then a value of 10 g/m<sup>3</sup> should be considered (see EN 50177).

All unauthorized conversions and modifications to the electrostatic spraying equipment are forbidden for safety reasons.

No safety devices should be dismantled or put out of operation.

Mandatory operational and workplace notices from the operating company must be written in a comprehensible manner in the language of equipment operators and posted in a suitable place.



***Slip hazard***

Powder lying on the floor around the powder spraying equipment is a potentially dangerous source of slipping. Booths may be entered only in the places suitable for it.

***Static charges***

Static charges can have the following consequences: Charges to people, electric shocks, sparking. Proper grounding must be in place to prevent objects from becoming charged.

***Grounding***

**Observe the grounding regulations**



All electrically conductive parts found in the workplace of 5 meters around each booth opening, and particularly the objects to be coated, have to be grounded. The grounding resistance of each object must amount to maximally 1 MOhm. This resistance must be checked/tested regularly when starting work.

The condition of the work piece attachments, as well as the hangers, must guarantee that the work pieces remain grounded. The appropriate measuring devices must be kept ready in the workplace, in order to check the grounding.

The floor of the coating area must conduct electricity (normal concrete is generally conductive).

The supplied grounding cable (green/yellow) must be connected to the grounding screw of the electrostatic manual powder coating equipment. The grounding cable must have a good metallic connection with the coating booth, the recovery unit and the conveyor chain, respectively with the suspension arrangement of the objects.

**Fire and smoke prohibition**



***Smoking and open flames***

Smoking and igniting fire are forbidden in the entire vicinity of the system! No work that could potentially produce sparks is allowed!

**The stay for persons with cardiac pacemakers is forbidden**



***Stay for persons with cardiac pacemakers***

As a general rule for all powder spraying installations, persons with pacemakers should never enter high voltage areas or areas with electromagnetic fields. Persons with pacemakers should not enter areas with powder spraying installations!

### Photographing with flashlight is forbidden



### Photographing with flashlight

Photographing with flashlight can lead to unnecessary releases and/or disconnections by safety devices.

### Disconnect from mains before maintenance works take place



### Maintenance works

Disconnect the plugs before the machines are opened for maintenance or repair.

The plug connections between the powder spraying equipment and the mains should only be removed when the power supply is switched off.



As far as it is necessary, the operating firm must ensure that the operating personnel wear protective clothing (e.g. facemasks).

A dust mask corresponding to filter class FFP2 or N95 at minimum must be worn during any cleaning work.

The operating personnel must wear electrically conductive, steel-toe footwear (e.g. leather soles).

The operating personnel should hold the gun with bare hands. If gloves are worn, these must also conduct electricity.



# OptiFlex Pro W

---

## Intended use

This Manual coating equipment is for use with organic powders coating electrostatically grounded objects.



*Fig. 1*

Observance of the operating, service and maintenance instructions specified by the manufacturer is also part of conformity of use. This product should only be used, maintained and started up by trained personnel, who are informed about and are familiar with the possible hazards involved.

Any other use is considered non-compliant. The manufacturer is not responsible for any incorrect use and the risks associated with such actions are assumed by the user alone!

## Reasonably foreseeable misuse

- Operation without the proper training
- Use with insufficient compressed air quality and grounding
- Use in connection with unauthorized coating devices or components

## Structure

### Overall view

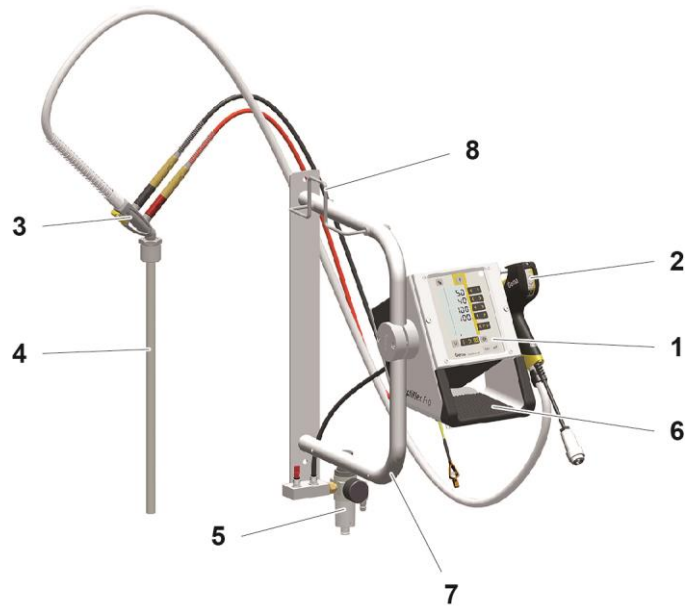

fig. 2

- |   |                                       |   |              |
|---|---------------------------------------|---|--------------|
| 1 | OptiStar CG21 Gun control unit        | 5 | Filter unit  |
| 2 | OptiSelect Pro GM04 manual powder gun | 6 | Shelf        |
| 3 | OptiFlow injector                     | 7 | Wall bracket |
| 4 | Suction tube                          | 8 | Hose holder  |

### ***OptiSelect Pro GM04 manual powder gun***

All information about the OptiSelect Pro GM04 manual powder gun can be found in the documentation for that equipment (enclosed with this manual)!

### ***OptiStar 4.0 Gun control unit***

All information about the OptiStar 4.0 (Type CG21) manual gun control unit can found in the documentation for that equipment (enclosed with this manual)!

### ***OptiFlow injector***

All information about the OptiFlow injector will be found in the corresponding enclosed documentation!

---

## Scope of delivery

- OptiSelect Pro GM04 manual powder gun with gun cable, powder hose, rinsing air hose and standard nozzle set (For more on this, see the operating manual for the OptiSelect Pro GM04 manual powder gun)
- OptiStar 4.0 Control unit in a metal case with power supply cable
- plug-in OptiFlow injector
- Wall bracket with gun/hose holder filter unit
- Suction tube
- PowerClean module\*\*
- Pneumatic hoses for conveying air (red), supplementary air (black) and rinsing air\*\* (black)
- Operating manual
- Short description

---

## Typical characteristics – properties of the functions

### The universal solution

The type W manual coating equipment can be integrated in any existing surrounding:

- to be mounted on booth walls for upgrades at your production site
- includes universal wall bracket
- takes the powder from fluidized hoppers of original powder box.

### PowerClean™ module – Option

#### *Field of application*

The PowerClean module can be used in combination with the OptiStar control unit.

The PowerClean module provides increased stability in application processes. It prevents the bridging phenomena that can lead to short circuiting when handling powders such as metallic powders.

In moist or tropical environments, any moisture is driven from the injector, powder hose and powder gun. The color change is also accelerated during non-extreme color switches.



*fig. 3*



## Technical Data

### Connectable guns

OptiFlex Pro W	connectable
OptiSelect Pro Type GM04	yes
OptiSelect type GM03	yes*
TriboJet	yes**

\* The PowderBoost functionality is not available

\*\* The gun type must be configured (refer to chapter "Additional functions"). The Tribo gun the gun is not type approved (ATEX).

### WARNING

**The gun control unit may only be used with the specified gun types!**

### Electrical data

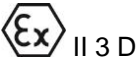
OptiFlex Pro W	
Nominal input voltage	100-240 VAC
Frequency	50-60 Hz
Fluctuations of the power supply	± 10 %
Overtoltage category	OVC II
Connected load	40 VA
Nominal output voltage (to the gun)	12 V
Nominal output current (to the gun)	1.2 A
Connection and output for vibrator (on Aux output)	100-240* VAC max. 100 W
Connection for rinsing function (valve)	24 VDC max. 3 W
Protection type	IP54
Approvals	 

### Pneumatic data

OptiFlex Pro W	
Compressed air connection	8 mm
Max. input pressure	5.5 bar / 80 psi
Max. water vapor content of the compressed air	1.3 g/m <sup>3</sup>
Max. oil vapor content of the compressed air	0.1 mg/m <sup>3</sup>

## Dimensions

OptiFlex Pro W	
Width	333 mm
Depth	460 mm
Height	697 mm
Weight	ca. 13 kg

## Processible powders

OptiFlex Pro W	
Plastic powder	yes
Metallic powder	yes
Enamel powder	no



## Powder output (reference values)

### General conditions for the OptiFlow Injector

Powder type	Epoxy/polyester
Powder hose Ø (mm)	11
Type of powder hose	POE with guide strips
Input pressure (bar)	5.5
Correction value C0	Powder output zeroing adjustment

### Guide values for OptiStar with OptiFlow Injector

All values in these tables are guide values for new nozzle inserts. Differing environmental conditions, wear and different powder types can affect the table values.

Hose internal diameter (mm)	Ø 11						
	6		12		18		
Hose length (m)							
Total air volume  (Nm³/h)	3.5	5.5	3.5	5.5	3.5	5.5	
<b>Powder output (g/min)</b>							
Powder output  (%)	20	90	105	65	75	45	60
	40	170	205	135	150	100	120
	60	235	280	185	215	145	170
	80	290	350	235	270	185	220
	100	340	405	280	320	220	260

## Air flow rates

The total air consists of conveying air and supplementary air, in relation to the selected powder quantity (in %). As a result the total air volume is maintained constant.

OptiFlex Pro W	Range	Factory setting
<b>Flow rate – fluidizing air:</b>		
– Device type B	0-1.0 Nm <sup>3</sup> /h	0.1 Nm <sup>3</sup> /h
– Device type F (without AirMover air requirements)	0-5.0 Nm <sup>3</sup> /h	1.0 Nm <sup>3</sup> /h
– Device type S (with optional fluid plate)	0-1.0 Nm <sup>3</sup> /h	0.1 Nm <sup>3</sup> /h
<b>Electrode rinsing air flow rate</b>	0-5.0 Nm <sup>3</sup> /h	0.1 Nm <sup>3</sup> /h
<b>Flow rate total air (at 5.5 bar)</b>	5 Nm <sup>3</sup> /h	
– Conveying air flow rate	0-5.5 Nm <sup>3</sup> /h	
– Supplementary air flow rate	0-5.5 Nm <sup>3</sup> /h	



**The max. total air consumption during the coating operation is < 5,5 Nm<sup>3</sup>/h:**

- Total air = 5 Nm<sup>3</sup>/h (conveying air + supplementary air)
- Electrode rinsing air = 0,1 Nm<sup>3</sup>/h (flat jet nozzle)



**The total air consumption for the device is determined based on the 3 configured air values (without AirMover air value for device type F).**

- These values apply for an internal control pressure of 5.5 bar!

## Environmental conditions

OptiFlex Pro W	
Utilization	in the interior
Height	up to 2 000 m
Temperature range	+5 °C - +40 °C (+41 °F - +104 °F)
Max. surface temperature	+85 °C (+185 °F)
Maximum relative humidity	80 % for temperatures to 31 °C, linearly decreasing to 50 % relative humidity at 40 °C
Environment	not for wet environment
Degree of pollution of the intended environment	2 (in accordance with DIN EN 61010-1)

## Sound pressure level

OptiFlex Pro W	
Normal operation	< 60 dB(A)

The sound pressure level was measured while the unit was in operation; measurements were taken at the most frequent operator positions and at a height of 1.7 m from the ground.

The specified value is applicable only for this product itself and does not take into account external noise sources or cleaning impulses.

The sound pressure level may vary, depending on the product configuration and space constraints.

## Rating plate



fig. 4



3	Electrode rinsing air hose	11	Fluidizing air hose
4	Powder hose	12	Maintenance unit
5	Supplementary air hose	13	OptiStar Control unit
6	Conveying air hose	14	Rinsing air hose
7	Control signal cable	15	AirMover
8	Injector	16	Fluidized powder hopper



---

**Use clamp to connect grounding cable to the cabin or the suspension arrangement.**

- ▶ Check ground connections with Ohm meter and ensure 1 MOhm or less.
- 



---

**The compressed air must be free of oil and water!**

---



---

**Close the unused connections with the provided dust protection caps!**

---

# Start-up

## Initial start-up



If a malfunction occurs, see the troubleshooting guide, as well as the gun control unit operating manual!

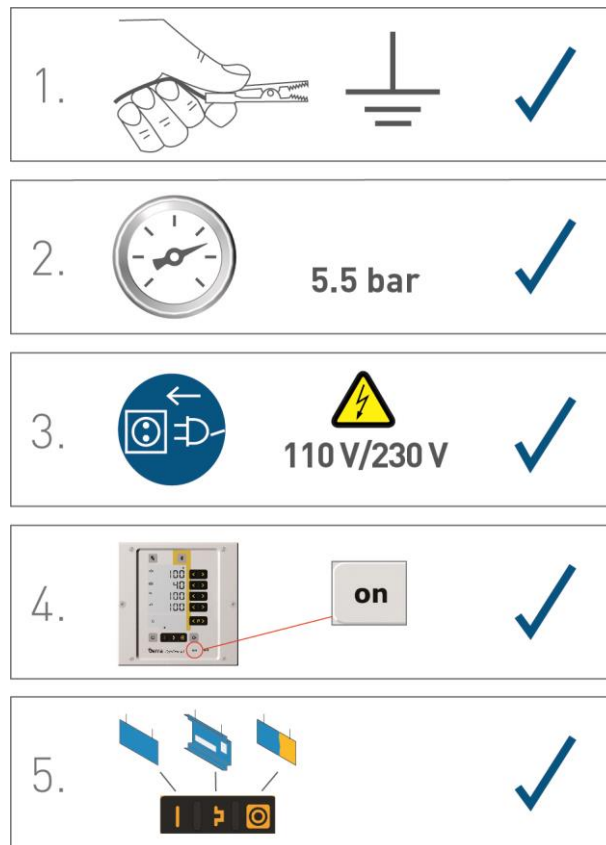

fig. 6



The remainder of the start-up procedure for the gun is explicitly described in the operating instructions for the OptiStar CGxx manual powder gun control unit (chapter "Initial start-up" and "Daily start-up")!

---

## Setting the device type



---

If the control unit is supplied as a component of a manual coating unit, then the corresponding system parameter is set correctly by the factory!

---

### **ATTENTION**

**A wrong parameterization leads to various malfunctions!**

- ▶ For more on this, please also see the operating instructions for the gun control unit!
-



# Operation

## WARNING

### Holding the gun incorrectly

During the coating process, the gun can discharge along the body of the coater if not held using its intended handle, which has been grounded.

- ▶ Always hold gun only by the handle!
- ▶ Do not touch any other parts of the gun!

---

# Operation

## CAUTION

### Large dust formation possible!

If the manual equipment is not being used for coating in conjunction with a sufficiently powerful suction unit, then the stirred-up dust from the coating powder can cause respiratory issues or cause a slippage/falling hazard.

- ▶ The manual equipment may only be operated in conjunction with a sufficiently powerful suction unit (such as Gema Classic Open booth).

1. Place powder hopper on the mobile trolley

## CAUTION

### Foot injury!

When setting the powder hopper onto the mobile trolley of the manual equipment, the hopper/trolley zone represents a threat of crushed toes

- ▶ Wear safety shoes with steel toecaps.

2. Set the ventilation (Airmover)
  - Open the ball valve completely
  - Calibrate with the throttle valve
3. Fill in powder
  - Open the powder hopper filling cover.
  - Fill in powder: Fill with maximum 25 kg (50 l) powder or the powder must reach to a maximum of 5-10 cm below the handles

of the powder hopper; otherwise the fluidized powder can escape from the cover.

- Close the filling cover of the powder hopper again.

4. Set coating parameters:

### Select predefined operating mode (Preset mode)

1. Turn on the gun control unit with the **ON** key
2. Press the corresponding application key.  
The arrow above the desired button lights up.

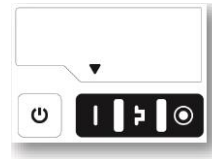

The pre-defined application modes have preset values for high voltage and spray current:

Application mode		Preset kV	Preset $\mu$ A
	flat parts	100	100
	complicated parts	100	22
	overcoat	100	10

3. The air values for total air, powder output and electrode rinsing air can be individually defined and are saved in the programs.

### Starting the individual adjustable programs

1. Turn on the gun control unit with the **ON** key
2. Press the **< P >** program key
3. Select the desired program (01-20)









Program 20 active

4. Change the coating parameters as required



**Programs 01-20 are preset at the factory but can be modified at any time, after which they are automatically stored.**

Description	Presetting
 Powder output	60 %
 Total air	4.0 Nm <sup>3</sup> /h
 High voltage	80 kV
 Spray current	20 µA
 Electrode rinsing air	0.1 Nm <sup>3</sup> /h
 Fluidizing air	1.0 Nm <sup>3</sup> /h (for device type F) 0.1 Nm <sup>3</sup> /h (for device type B and S)

## Setting powder output and powder cloud

The powder output depends on the selected powder output (in %), and the powder cloud on the selected total air volume.



**As a factory default value, a powder rate of 50% and a total air volume of 4 Nm<sup>3</sup>/h are recommended.**

- If values are entered that the gun control unit cannot implement, then the operator is informed of this by a blinking in the relevant display and a temporary error message!

### Setting the total air volume



Adjust the total air volume on the gun control unit with the **T3/T4** keys

- Adjust the total air volume according to the corresponding coating requests



*correct powder cloud*

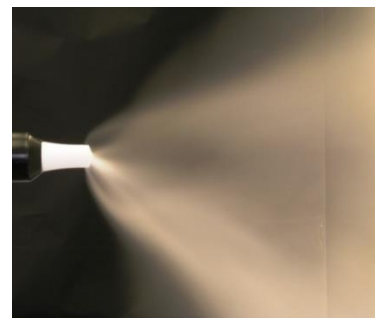

*too little total air*

### Setting the powder output





*much powder*



*little powder*

Adjust the powder output volume (e.g. according to the desired coating thickness)

- Factory default setting of 50% is recommended for initial operation. The total air volume is thereby kept constant automatically by the control unit.



**To achieve maximum efficiency, we recommend avoided an overly high powder volume where possible!**

2. Check fluidization of the powder in the powder container
3. Point the gun into the booth, switch the gun on and visually check the powder output

### Setting the electrode rinsing air

1. Press the  key.  
The second display level will be shown.



2. Adjust the correct electrode rinsing air according to the applied nozzles (deflector plate, flat jet nozzle)

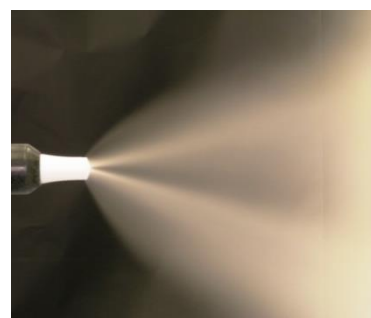
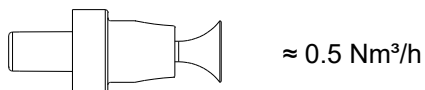
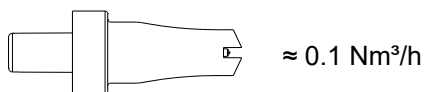

*too much electrode rinsing air*

3. If in this display level is no operation for 3 seconds, the first display level is switched over independently.

## Setting the fluidization

The fluidization can be adjusted on the manual units type B, Q, F, L and S.

The powder fluidization depends on the powder type, the air humidity and the ambient temperature. Fluidizing and vibration start by switching on the control unit.

### Procedure:

1. Configure AirMover by opening the ball valve complete and adjusting with the flow control valve (equipment type F only)
2. Open the powder container cover (equipment type F only)

3. Press the  key

The second display level will be shown

4. 

Adjust the fluidizing air with the keys **T5/T6**

- If in this display level is no operation for 3 seconds, the device switches back to the first display level
  - The powder should only be touched gently, but should be "cooked" regularly and is also to be stirred using a rod
5. Close again the cover

## Rinsing mode

The rinsing mode enables blowing off powder accumulations in the powder hose.

### Activating the rinsing function

#### **Manual equipment without optional PowerClean module (system parameter P01=0)**

The rinsing mode can only be activated from standby mode (main menu display, no powder conveying).



**On manual coating equipment type F, the injector must be disconnected prior to cleaning procedure, on type B, the suction unit must be lifted, and on type S, the powder container must be empty.**

1. Detach the injector



- 2.

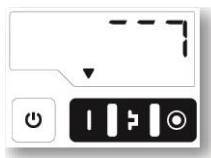

3. **START =**



**1 x**  
= Automatic Procedure

**2 x**  
= Manual Procedure

Procedure	Effect
<b>Automatic (automatic)</b>	<ul style="list-style-type: none"> <li>- The rinsing process is started</li> <li>- Injector, powder hose, gun and spray nozzle are purged using compressed air</li> <li>- The PowerClean function enables parallel cleaning of other components, such as the fluid intake unit, powder container, etc.</li> <li>- The rinsing mode is exited if the automatic rinsing sequence has finished.</li> </ul>
<b>Manual (manual)</b>	The operator controls the number and length of the PowerClean impulse by pressing the gun trigger a second time

4. **STOP =**



OR the cleaning mode is terminated automatically.

After completion of the PowerClean procedure, the controller switches back to coating mode.

**Manual equipment with optional PowerClean module (system parameter P01= 1 or P01=2)**

The rinsing mode can only be activated from standby mode (main menu display, no powder conveying).

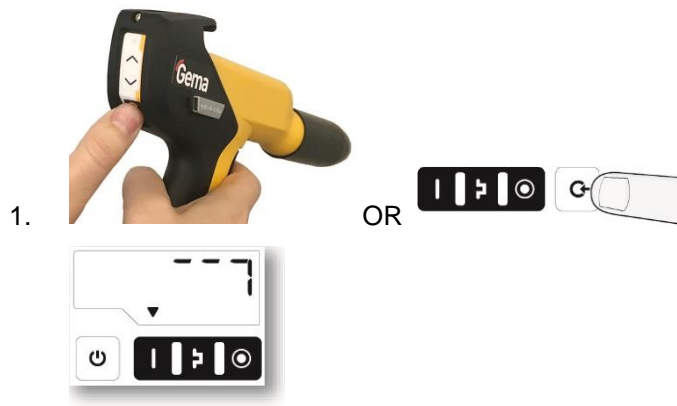

2. **START =**



Procedure	Effect
<b>Automatic (automatic)</b>	<ul style="list-style-type: none"> <li>– The rinsing process is started</li> <li>– Injector, powder hose, gun and spray nozzle are purged using compressed air</li> <li>– The PowerClean function enables parallel cleaning of other components, such as the fluid intake unit, powder container, etc.</li> <li>– The rinsing mode is exited if the automatic rinsing sequence has finished.</li> </ul>
<b>Manual (manual)</b>	The operator controls the number and length of the PowerClean impulse by pressing the gun trigger a second time

3. **STOP =**



OR the cleaning mode is terminated automatically.

After completion of the PowerClean procedure, the controller switches back to coating mode.



---

## Color change

### General information

When a color change takes place, the individual components of the manual coating equipment must be cleaned carefully. All powder particles of the former color must be removed during this process!

The following describes an 'extreme' color change (light to dark).

1. End the coating procedure
2. Remove the injector from the suction tube
3. The rinsing mode can be activated either on the rear of the powder gun (remote control) or on the control unit
4. Point the gun into the booth
5. Press the gun trigger
  - The rinsing process is started
6. Clean the powder hose:
  - Disconnect the powder hose from the hose connection on the injector
  - Point the gun into the booth
  - Blow through the hose manually with a compressed air gun
  - Connect the powder hose again to the hose connection on the injector
7. Dismantle and clean the powder gun (see therefore the user manual of the powder gun)
8. Clean the injector (see therefore the injector user manual)
9. Disconnect the fluidizing air supply
10. Remove cover, purge with compressed air and clean with a clean, dry brush and cloth
11. Clean the suction tube
12. Empty remaining powder into a container
13. Vacuum up the hopper and in particular the bottom
14. Clean container with a cloth
15. Reassemble the powder hopper
16. Fill with new powder
17. Prepare the manual coating equipment with new powder for start-up



# Decommissioning / Storage

---

## Decommissioning

1. End the coating procedure
2. Switch off the control unit



---

**The adjustments for high voltage, powder output volume and electrode rinsing air remain stored.**

---

### **If in disuse for several days**

1. Separate from power mains
2. Clean guns, injectors and powder hoses (see therefore the corresponding user manuals)
3. Turn off the compressed air main supply



# Maintenance / Repairs

---

## General information

The product was designed for a maintenance-free operation.

### ATTENTION

**Any unauthorized modifications and alterations to the product are not permitted for safety reasons and exclude the manufacturer's liability for any resulting damage!**



**Regular and conscientious cleaning and maintenance increase the service life of the product and ensure consistent high coating quality!**

- The parts to be replaced during maintenance work are available as spare parts. These parts can be found in the appropriate spare parts list!

---

## Interval

### Daily maintenance

1. Clean the injector (see therefore the user manual of the OptiFlow injector)
2. Clean the powder gun (For more on this, please also review the user manual for the OptiSelect GM03 manual powder gun)
3. Clean the powder hose; Please also review the section "Color change"

### Weekly maintenance

1. Clean powder container, injector, rinsing module\*\* and powder gun.
2. Check the control unit grounding connections to the coating booth, the suspension devices of the work pieces, or the conveyor chain

### **If in disuse for several days**

1. Separate from power mains
2. Clean the coating equipment
3. Turn off the compressed air main supply

### ***Powder hose rinsing***

If longer downtimes take place, the powder hose has to be cleaned.

#### **Procedure:**

1. Disconnect the powder hose from the hose connection on the injector
2. Point the gun into the booth
3. Blow through the hose manually with a compressed air gun
4. Connect the powder hose again to the hose connection on the injector

### **Gun maintenance**

The gun is designed to require only a minimum amount of maintenance.

1. Clean the gun with dry cloth, see chapter "Maintenance"
2. Check connection points to powder house.
3. Replace the powder hoses, if necessary.

## Cleaning

### CAUTION

**Large dust formation possible!**

**If no dust mask or one of an insufficient filter class is worn when cleaning the product, then the dust that is stirred up from the coating powder can cause respiratory problems.**

- ▶ The ventilation system must be turned on for all cleaning work.
- ▶ A dust mask corresponding to filter class FFP2 or N95 at minimum must be worn during any cleaning work.

## Gun cleaning

### ATTENTION

**Impermissible solvents**

**The following solvents may not be used to clean the gun:**

- ▶ Ethylene chloride, acetone, ethyl acetate, methyl ethyl ketone, methylene chloride, premium gasoline, turpentine, tetrachloromethane, toluene, trichloroethylene, xylene!



**Only cleaning agents with a flash point of a least 5 Kelvin above the ambient temperature, or cleaning places with technical ventilation are allowed!**



**Before cleaning the powder gun, switch off the control unit. The compressed air used for cleaning must be free of oil and water!**

### **Daily:**

1. Blow off the outside of the gun and wipe, clean etc.

### **Weekly:**

2. Remove powder hose
3. Remove the spray nozzle from the gun and clean it with compressed air
4. Blow through the gun with compressed air, beginning from the connection in flow direction
5. Clean the integrated gun tube with the brush supplied if necessary
6. Blow through the gun with compressed air again
7. Clean the powder hose
8. Reassemble the gun and connect it

## Cleaning the powder container

**ATTENTION****Damage to the fluidizing plate**

- ▶ Never clean the powder container with solvents or water!

1. Disconnect the fluidizing air supply
2. Remove the injector
3. Remove PowerClean module\*\*
4. Remove the cover, blow out with compressed air and clean with a clean dry brush and cloth
5. Clean the injector and suction intake pipe (Please review injector manual for more on this)
6. Clean rinsing module\*\*
7. Empty remaining powder into a container
8. Vacuum up the hopper and in particular the bottom
9. Clean container with a cloth
10. Reassemble the powder hopper



---

**Do not refill the powder container until just before the next use!**

---



# Fault clearance



**Prior to any troubleshooting measures, always check whether the equipment parameter (P00) as configured in the control unit is correct**

- ▶ See operating instructions for the manual gun control unit, Chapter "Initial Start-up – Setting Equipment Type"!

Incident	Causes	Corrective action
<b>H11 (Help code on control unit)</b>	Gun not connected	Connect the gun
	Gun plug or gun cable defective	Contact local Gema representative
	Remote control on powder gun defective	Contact local Gema representative
<b>Control unit displays remain dark, although the control unit is switched on</b>	Control unit is not connected to the mains	Connect the equipment with the mains cable
	Power pack fuse defective	Replace the fuse
	Power pack defective	Contact local Gema representative
<b>Gun LED remains dark, although the gun is triggered</b>	High voltage adjustment is set too low	Increase high voltage
	Gun plug or gun cable defective	Contact local Gema representative
	LED on gun defective	Contact local Gema representative
<b>Powder does not adhere to object, although the gun is triggered and sprays powder</b>	High voltage and current deactivated	Check the high voltage and current setting
	High voltage cascade defective	Contact local Gema representative
	The objects are not properly grounded	Check the grounding
<b>The gun does not spray powder, although the control unit is switched on and the gun trigger is pressed</b>	Compressed air not present	Connect the equipment to the compressed air
	Injector or nozzle on the injector, powder hose or powder gun clogged	Clean the corresponding part
	Insert sleeve in the injector is clogged	Clean/replace
	Fluidization not running	see below

Incident	Causes	Corrective action
	Pressure valve in the control unit defective	Replace
	Solenoid valve in the control unit defective	Replace
	No conveying air: <ul style="list-style-type: none"> <li>– Throttle motor defective</li> <li>– Solenoid valve defective</li> </ul>	Contact local Gema representative
	Front plate defective	Contact local Gema representative
<b>Gun achieving only poor spray profile</b>	Total air incorrectly configured	Increase the powder quantity and/or total air volume on the control unit
	Bend or damage to air lines to injector	Check air lines to injector
	Insert sleeve in the injector worn or not inserted	Replace or insert it
	Fluidization not running	see below
<b>No electrode rinsing air</b>	Rinsing air throttle motor defective	Contact local Gema representative
<b>The powder is not fluidized</b>	Compressed air not present	Connect the equipment to the compressed air
	Fluidizing air is set too low on the control unit	Set the fluidizing air correctly
	Throttle motor defective	Contact local Gema representative
<b>Powder flows out of the powder hopper</b>	Airmover pressure incorrectly set	Adjust

# OptiStar CG21



For further information, see the corresponding operating manual, which can be found on the accompanying CD.

## Design and function

### Overall view



Fig. 7

- |   |   |   |                            |
|---|---|---|----------------------------|
| 1 | Front plate with control and display elements | 3 | Back panel with interfaces |
| 2 | Enclosure                                     |   |                            |

## Operating elements

### Displays



The desired and actual values are distributed across several levels.

- The  key is used to switch between the levels.
- If no controls are used within 6 s, the device automatically returns to level 1.

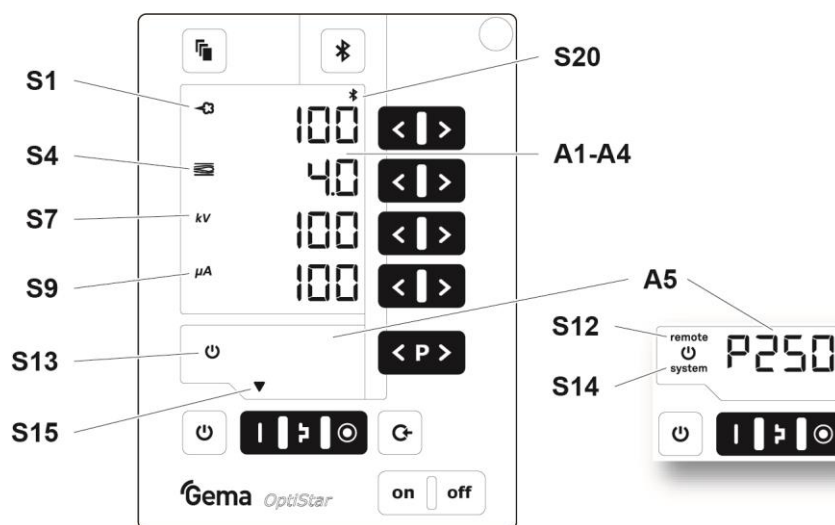

Fig. 8: Displays, Level 1

Designation	Function
A1-A4	Display of actual values, desired values and system parameters - Flashes when the possible range is exceeded.
A5	Display of program numbers, error diagnosis codes and status information
S1	Powder output (display in %)
S4	Total air volume (display in Nm <sup>3</sup> /h)
S7	High voltage (display in kV)
S9	Spray current (display in µA)
S12 remote	Remote operation mode, no local operation possible - Remote operation mode is used as keyboard lock, reduced operation is possible
S13	Gun release
S14 system	System release via external release
S15	Display of predefined operating modes or display of cleaning mode during cleaning
S20	- Display of readiness for pairing the Bluetooth module with a mobile device (green) - Display of an active connection (blue)

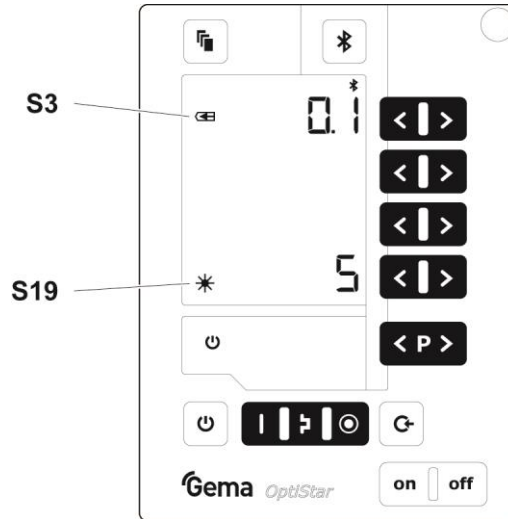

fig. 9: Displays and LEDs, Level 2

Designation	Function
S3	Electrode rinsing air (display in Nm <sup>3</sup> /h)
S19	Display background illumination (0-8)

**Input keys and switches**

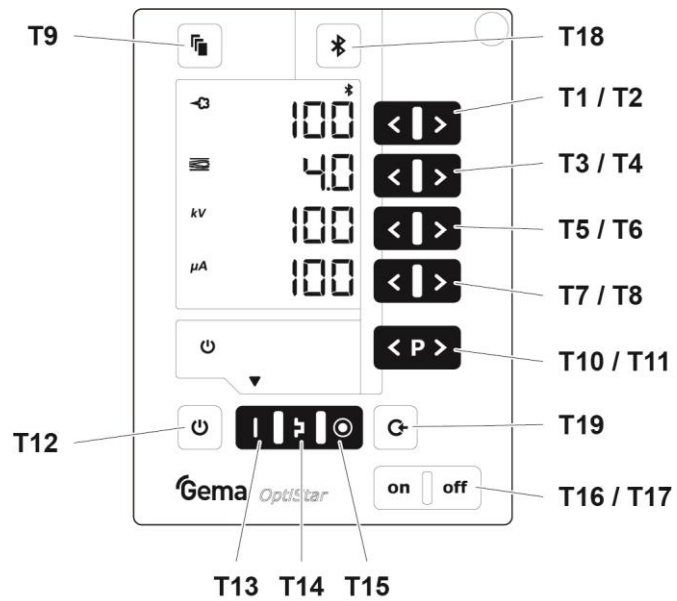

fig. 10: Input keys and switches

Designation	Function
T1-T8	Input keys for desired values and system parameters
T9	Switch between display levels
T10-T11	Program change

Designation	Function
<b>T12</b>	<ul style="list-style-type: none"> <li>– Switching on and off the fluidization (equipment type F)</li> <li>– Switch on/off for vibration and fluidization (equipment type B)</li> <li>– Switching on and off the stirrer (equipment type S)</li> <li>– Switchover to system parameter mode (press for at least 5 secs.)</li> </ul>
<b>T13</b>	Preset mode for flat parts (fixed values)
<b>T14</b>	Preset mode for complex parts with depressions (fixed values)
<b>T15</b>	Preset mode for overcoating parts already coated (fixed values)
<b>T16/T17</b>	Power switch On/Off
<b>T18</b>	<ul style="list-style-type: none"> <li>– Activation of the pairing readiness from the Bluetooth module to the mobile device (press for at least 2 seconds)</li> <li>– Display of the ID number (press for a short time)</li> </ul>
<b>T19</b>	<ul style="list-style-type: none"> <li>– Switching on the rinsing mode (PowerClean) with optional PowerClean module</li> <li>– Terminating the rinsing mode (PowerClean) with optional PowerClean module</li> </ul>

# Fault clearance

## Error diagnosis of the software

### General information

The correct function of the Gun control unit is constantly monitored. If the equipment software determines a fault, an error message is indicated with a help code. Following is monitored:

- High voltage technology
- Pneumatic system
- Power supply

### Help codes

The error diagnosis codes (help codes) are shown in red on the **A5** display.

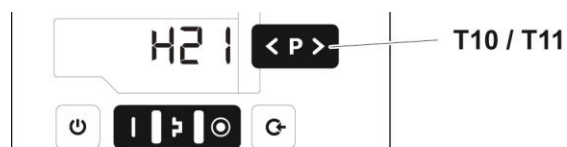

The help codes are stored in an error list in the order of their appearance. Each error in the list must be individually acknowledged with the keys **T10** or **T11**.

The errors are displayed in the order of their appearance. The **T10** and **T11** keys cannot be used for other functions, as long as an error code is still shown.

Here is a list of all possible help codes for this Gun control unit:

Code	Description	Criteria	Remedy
<b>Pneumatics:</b>			
H05	PowerClean valve	<ul style="list-style-type: none"> <li>– PowerClean valve not connected</li> <li>– Valve defective</li> <li>– Connection cable defective</li> <li>– Mainboard defective</li> </ul>	<p>connect or replace</p> <p>Contact a Gema service center</p>

Code	Description	Criteria	Remedy
H06	Trigger valve	Solenoid coil current lower than preset limiting value Valve defective, main board or cable defective	Contact a Gema service center
H07	Supplementary air volume too high (setting of supplementary air on the display)	The preset value for supplementary air is too high compared to the conveying air setting	Lower supplementary air value or increase value for conveying air to equalize air volumes to the injector, delete error code
H08	Conveying air volume too high (setting of powder share on the display)	The preset value for conveying air is too high compared to the supplementary air setting	Lower conveying air value or increase value for supplementary air to equalize air volumes to the injector, delete error code
H09	Powder output higher than 100%	The powder output multiplied by the powder hose length factor and daily correction value is greater than 100% Daily correction value too large	Reduce powder output  Reduce daily correction value
H10	Conveying air range lower deviation	The theoretical value for conveying air falls below minimum Total air is smaller than minimum	Limit conveying air to its minimum value
<b>High voltage:</b>			
H11	Gun error	No vibrations in the oscillator, cable break, oscillator or gun is defective	Contact a Gema service center
H13	Gun Overload	Cable or cascade defective. The control unit is switched off.	Contact a Gema service center
<b>Power supply:</b>			
H20	Voltage supply error Mainboard	Mainboard defective	Contact a Gema service center
H21	Supply undervoltage	Power pack defective or overloaded	Contact a Gema service center
H22	Wrong internal system clock	Backup battery is empty	Contact a Gema service center
<b>EEPROM (equipment memory):</b>			
H24	EEPROM content invalid	EEPROM error	Contact a Gema service center
H25	Timeout during EEPROM writing	EEPROM error	Contact a Gema service center
H26	Values not correctly stored in EEPROM during switching off	EEPROM error	Contact a Gema service center
H27	EEPROM verification erroneous	EEPROM error	Contact a Gema service center
<b>Throttle motors:</b>			
H60	Conveying air reference position not found	Throttle motor or needle jammed, limit switch defective, error in motor throttle	Contact a Gema service center



Code	Description	Criteria	Remedy
H61	Supplementary air reference position not found	Throttle motor or needle jammed, limit switch defective, error in motor throttle	Contact a Gema service center
H62	Electrode rinsing air reference position not found	Throttle motor or needle jammed, limit switch defective, error in motor throttle	Contact a Gema service center
H63	Fluidizing air reference position not found	Throttle motor or needle jammed, limit switch defective, error in motor throttle	Contact a Gema service center
H64	Conveying air throttle does not move	Short circuit in limit switch, motor throttle defective	Contact a Gema service center
H65	Supplementary air throttle does not move	Short circuit in limit switch, motor throttle defective	Contact a Gema service center
H66	Electrode rinsing air throttle does not move	Short circuit in limit switch, motor throttle defective	Contact a Gema service center
H67	Fluidizing air throttle does not move	Short circuit in limit switch, motor throttle defective	Contact a Gema service center
H68	Conveying air position lost	Lost steps, limit switch defective, throttle motor defective	Contact a Gema service center
H69	Supplementary air position lost	Lost steps, limit switch defective, throttle motor defective	Contact a Gema service center
H70	Electrode rinsing air position lost	Lost steps, limit switch defective, throttle motor defective	Contact a Gema service center
H71	Fluidizing air position lost	Lost steps, limit switch defective, throttle motor defective	Contact a Gema service center
<b>Communication mainboard-gun:</b>			
H91	Communication error mainboard-gun	Gun not connected Gun, gun cable or Mainboard defective	connect Replace or contact Gema Service

## Help codes list

The last appeared four errors are stored in a list by the software. If an error appears, which is already in the list, he will not be listed again.

## Appearance of errors

It is possible that an error is only displayed for a short time, but after the acknowledgement it will disappear. In this case, it's recommended to switch off the control unit and switch it on again (reset by restarting).



# OptiSelect Pro GM04



For further information, see the corresponding operating manual, which can be found on the accompanying CD.

## Structure

### Overall view



fig. 11:

- |   |                        |    |   |
|---|------------------------|----|---|
| 1 | Spray nozzle system    | 8  | Gun cable                                       |
| 2 | Threaded sleeve        | 9  | Powder hose connection                          |
| 3 | Shaft                  | 10 | Powder hose quick release connection (grounded) |
| 4 | Rear part with hook    | 11 | Electrode rinsing air connection                |
| 5 | Remote control         | 12 | Trigger   |
| 6 | SuperCorona connection |    |   |
| 7 | Gun handle             |    |   |

## Operating elements

### LED and remote control buttons

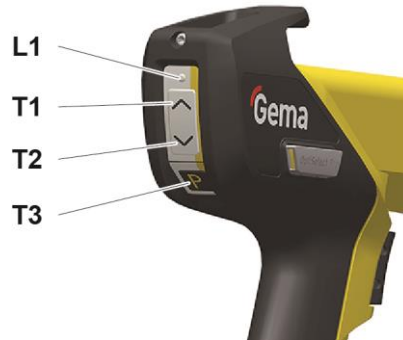

fig. 12

Designation	Function
L1	Display <b>High voltage (intensity)</b>
T1	Key <b>Increase value</b>
T2	Key <b>Decrease value</b>
T3	Key <b>P</b> – Function according to system parameter in the OptiStar control unit



## Available accessories\*\*

- SuperCorona ring
- Flat jet nozzles
- Round jet nozzles
- Gun extension 150 and 300 mm
- Gun cable extensions
- Application cup 150 and 500 ml
- Multi-spray adapter
- Rinsing module (with corresponding OptiStar control unit only)
- Various adapters for connection to earlier generations of control units
- Gloves, anti-static

\*\*for more information, see spare parts list

## Technical Data

### Electrical data

OptiSelect Pro GM04	
Nominal input voltage	eff. 10 V
Frequency	18 kHz (average)
Nominal output voltage	110 kV
Polarity	negative <sup>[1]</sup> (optional positive)
Max. output current	110 µA
High voltage display	with LED
Ignition protection	Ex 2 mJ T6
Temperature range	5 °C - +40 °C (+41 °F - +104 °F)
Max. surface temperature	85 °C (+185 °F)
Protection type	IP64
Approvals	 0102  II 2 D PTB 19 ATEX 5001

### Dimensions

OptiSelect Pro GM04	
Weight	550 g

### Processible powders

OptiSelect Pro GM04	
Plastic powder	yes
Metallic powder	yes
Enamel powder	no



# Fault clearance



**Additional error descriptions are to be found also in the control unit operating instructions!**

Incident	Causes	Corrective action
<b>H11 (Help code on control unit)</b>	Gun not connected	Connect the gun
	Gun plug or gun cable defective	Contact local Gema representative
	Remote control on powder gun defective	Contact local Gema representative
<b>Gun LED remains dark, although the gun is triggered</b>	High voltage adjustment is set too low	Increase high voltage
	Gun plug or gun cable defective	Contact local Gema representative
	LED on gun defective	Contact local Gema representative
<b>Powder does not adhere to object, although the gun is triggered and sprays powder</b>	High voltage and current deactivated	Check the high voltage and current setting
	High voltage cascade defective	Contact local Gema representative
	The objects are not properly grounded	Check the grounding
<b>The gun does not spray powder, although the control unit is switched on and the gun trigger is pressed</b>	Compressed air not present	Connect the equipment to the compressed air
	Injector or nozzle on the injector, powder hose or powder gun clogged	Clean the corresponding part
	Insert sleeve in the injector is clogged	Clean/replace
	Pressure valve in the control unit defective	Replace
	Solenoid valve in the control unit defective	Replace
	No conveying air: <ul style="list-style-type: none"> <li>– Throttle motor defective</li> <li>– Solenoid valve defective</li> </ul>	Contact local Gema representative
	Front plate defective	Contact local Gema representative

<b>Incident</b>	<b>Causes</b>	<b>Corrective action</b>
<b>Gun achieving only poor spray profile</b>	Total air incorrectly configured	Increase the powder quantity and/or total air volume on the control unit
	Bend or damage to air lines to injector	Check air lines to injector
	Insert sleeve in the injector worn or not inserted	Replace or insert it
	Fluidization not running	see above



# OptiFlow IG07



For further information, see the corresponding operating manual, which can be found on the accompanying CD.

## Structure

### Overall view

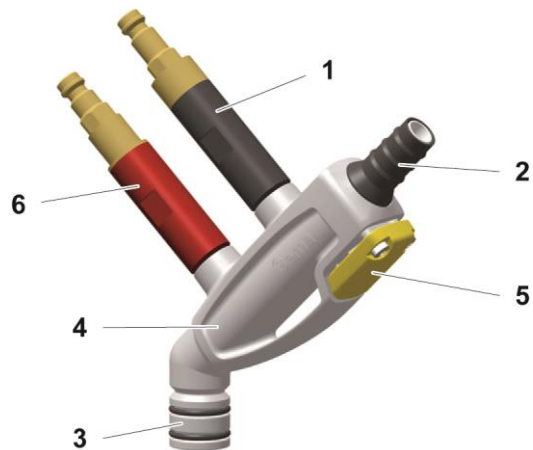

Fig. 13

- |   |   |   |                                     |
|---|---|---|-------------------------------------|
| 1 | Check valve unit<br>(supplementary air) | 4 | Injector housing                    |
| 2 | Powder hose quick release<br>connection | 5 | Release trigger                     |
| 3 | Powder hopper connection                | 6 | Check valve unit<br>(conveying air) |

---

## Powder volume setting for OptiFlow Injector

In order to set the ideal powder volume on the OptiStar gun control unit, it is recommended to select the firmness of the powder cloud or the total air first. As guide values for different powder hoses, the following can be assumed:

- Powder hose 74 type, Ø 10 mm, **3-5 m<sup>3</sup>/h**
- Powder hose 66 type, Ø 11 mm, **4-5 m<sup>3</sup>/h**

According to the prevailing conditions (powder, powder hose layout, the parts to be coated) a low to lowest total air can also be set with the standard hose 74 type, Ø 10 mm.

If a very large powder output is required, it is recommended to select a larger powder hose internal diameter (Ø 12 mm).



---

**It should be noted, that if irregular or pumping conveying occurs, as a rule, the total air is set too low!**

---

# Maintenance / Repairs

---

## Cleaning

### ATTENTION

**Any unauthorized modifications and alterations to the product are not permitted for safety reasons and exclude the manufacturer's liability for any resulting damage!**



**Regular and conscientious cleaning and maintenance increase the service life of the product and ensure consistent high coating quality!**

- The parts to be replaced during maintenance work are available as spare parts. These parts can be found in the appropriate spare parts list!

---

## Cleaning the injector

### ATTENTION

**Injector parts may be damaged during the cleaning process.**

- ▶ Clean the component parts with compressed air and, if necessary, dissolve sintered deposits with nitro-thinner.
- ▶ Do not use acetone, do not scrape!

Cleaning intensity depends of the powder used. For optimal cleaning results, we recommend dismantling the entire injector into its dismantable components.

1. Remove the injector
2. Remove the powder hose from the hose connection
3. Clean the hose connection with compressed air which is free of oil and water, and check for wear
4. Clean the injector body with compressed air which is free of oil and water.
  - Any contamination can be seen through the opening of the hopper fitting
5. If the injector is severely fouled, it must be dismantled

**ATTENTION**

**Individual parts may be damaged during the cleaning process.**

- ▶ Please dismantle carefully to avoid damages!
- ▶ Remove the check valve units (1 and 6) with the correct sized spanner.

6. Reinsert the injector and fix it

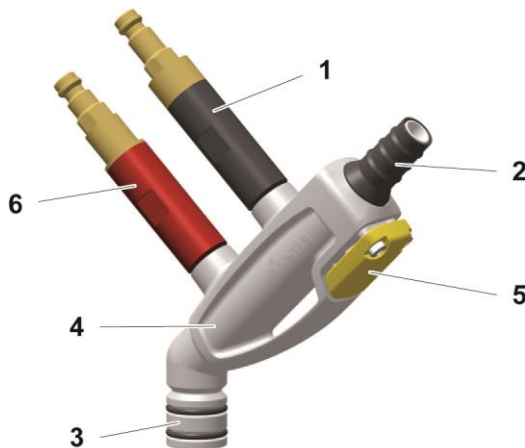

fig. 14

- |  |                                    |
|--|------------------------------------|
| 1 Check valve unit (supplementary air) | 4 Injector housing                 |
| 2 Powder hose quick release connection | 5 Release trigger                  |
| 3 Powder hopper connection             | 6 Check valve unit (conveying air) |

## Cleaning the check valve units

**ATTENTION**

**Damage or loss of function!**

**Parts of the check valve unit may be damaged during the dismantling process.**

- ▶ Blow off the filter elements from the inside to the outside!
- ▶ Do not immerse the filter elements in fluidities or solvents!
- ▶ Never remove the supporting ring!

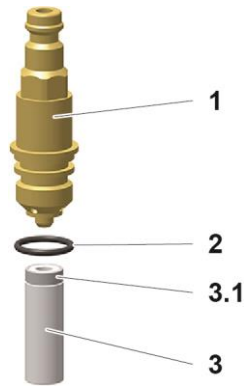
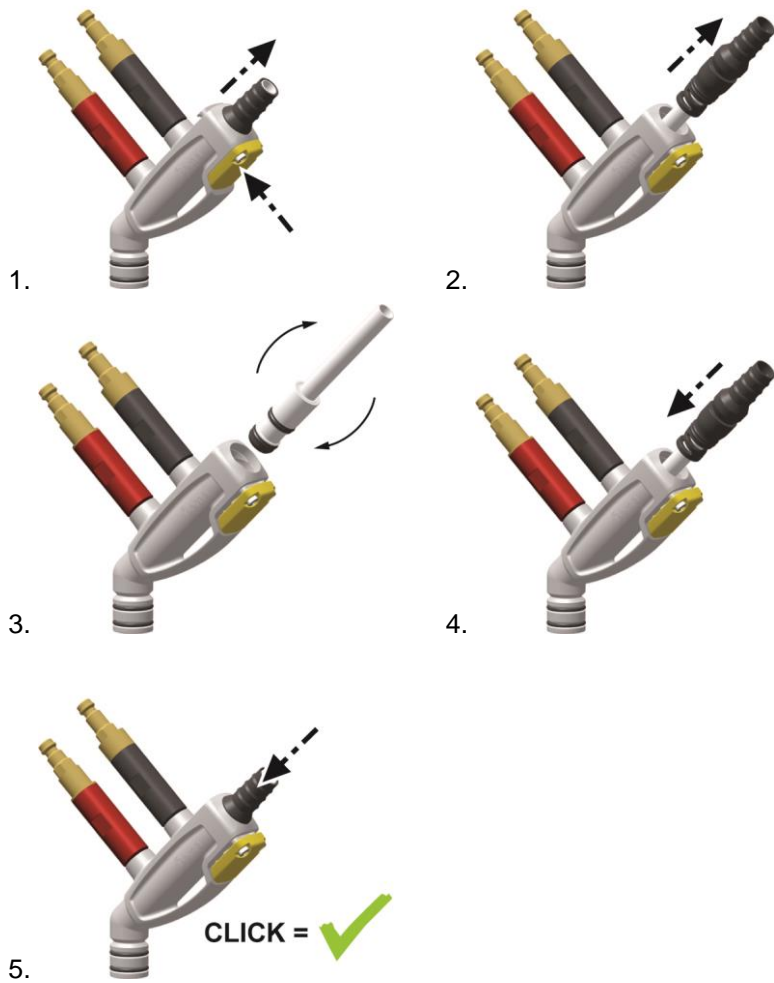

fig. 15

- 1 Connection/plug
- 2 O-ring

- 3 Filter element
- 3.1 Supporting ring

## Changing the cartridge





# Fault clearance

---

## Faults

The following lists possible faults during operation and their clearance.

Fault	Cause	Corrective action
<b>The gun does not spray powder although the control unit is switched on</b>	Injector nozzle, check valve unit, powder hose or powder gun are clogged	Clean the corresponding parts and if necessary, replace them
<b>Gun achieving only poor spray profile</b>	Conveying vacuum too low	Increase the powder quantity and/or total air volume on the control unit
	Cartridge worn, clogged or not inserted	Replace or install the cartridge.





# Spare parts list

---

## Ordering spare parts

When ordering spare parts for powder coating equipment, please indicate the following specifications:

- Type and serial number of your powder coating equipment
- Order number, quantity and description of each spare part

**Example:**

- **Type** OptiGun GA03 automatic powder gun  
Serial number 1234 5678
- **Order no.** 203 386, 1 piece, Clamp – Ø 18/15 mm

When ordering cable or hose material, the required length must also be given. The spare part numbers of this bulk stock is always marked with an \*.

Wearing parts are always marked with a #.

All dimensions of plastic hoses are specified with the external and internal diameter:

**Example:**

Ø 8/6 mm, 8 mm outside diameter (o/d) / 6 mm inside diameter (i/d)

### ATTENTION

**Use of non-original Gema spare parts**

**When using the spare parts from other manufacturers the explosion protection is no longer guaranteed. If any damage is caused by this use all guarantee claims become invalid!**

- ▶ Only original Gema spare parts should be used!
-

## OptiFlex Pro W – Spare parts list

1	OptiStar CG21 gun control unit – complete (see corresponding operating manual)	
2	OptiSelect Pro GM04 Manual powder gun – complete (see corresponding user manual)	
3	OptiFlow IG07 injector – complete (see corresponding user manual)	
4	Pneumatic connection for supplementary air	
4.1	Quick release connection – NW5, Ø 8 mm, black	261 637
4.2	Nut with kink protection – M12x1 mm, Ø 8 mm	201 316
4.3	Plastic tube – Ø 8/6 mm, black	1008 038*
5	Pneumatic connection for conveying air	
5.1	Quick release connection – NW5, Ø 8 mm, red	261 645
5.2	Nut with kink protection – M12x1 mm, Ø 8 mm	201 316
5.3	Plastic tube – Ø 8/6 mm, red	103 500*
6	Kink protection	1008 844
7	Locknut – PG21	234 869
8	Suction tube – complete, L=504 mm (incl. pos. 9)	1009 063#
9	O-ring – Ø 28.3x1.78 mm	224 987
10	Pneumatic group – complete (see corresponding spare parts list)	
11	Quick release connection – NW7.8 – Ø 10 mm	239 267
12	Hose clamp – Ø 15-18 mm	203 386
13	Plastic tube – Ø 8/6 mm, black	103 152*
14	Grounding cable – complete	301 140
15	Powder hose – dia. 15/10 mm	1001 673*#
16	Spare parts kit – consisting of:	
	Cartridge – complete (1x)	1016 561
	O-ring – Ø 16x2 mm (2x)	1007 794
	Multi-Tool for OptiFlow IG07 (1x)	1017 201
	Cable tie (6x)	200 719
17	Power cable – country-specific (not shown)	
18	Short instructions (not shown)	1017 907
19	Operating instructions (not shown)	1018 957

\* Please indicate length

# Wearing part

# OptiFlex Pro W – Spare parts

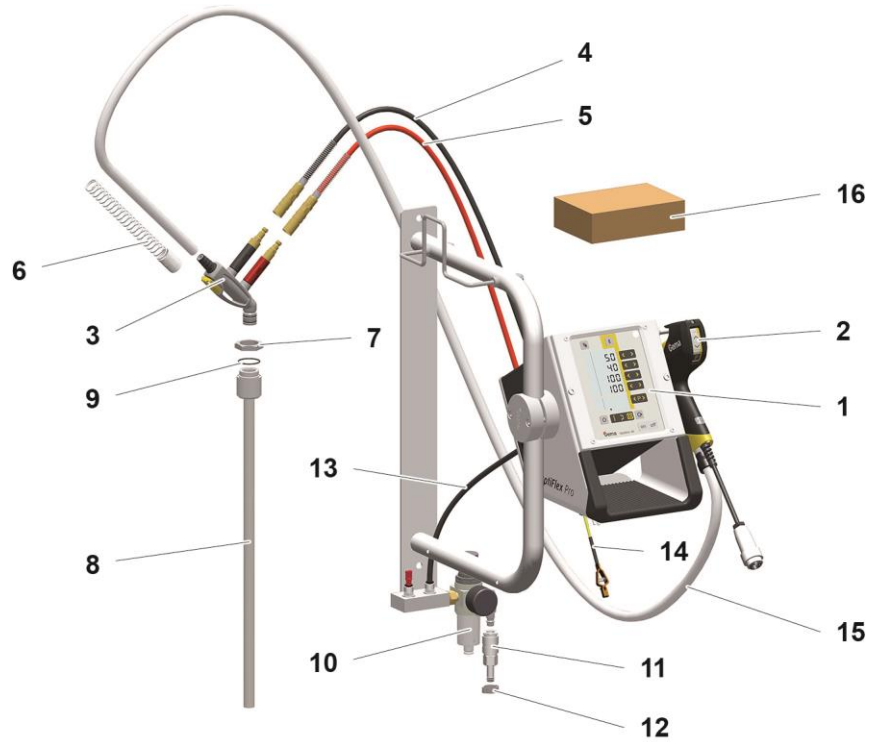

fig. 16:

## Pneumatic group

	Pneumatic group – complete	1017 815
1	Filter cartridge – 20 µm	1008 239#
2	Condensate container with drain valve	1008 238
3	Connector – NW7.4 - 1/4"	256 730
4	Elbow joint – 1/4"-1/4"	222 674
5	Sealing plug – 1/8"	203 297
6	R/F unit – 0-8 bar, 1/4", complete (incl. pos. 1 and 2)	1008 236
7	Double nipple – 1/4"1/4", divisible	261 165
8	Pressure gauge – 0-10 bar, 1/8"	1008 049
9	Distribution block	1017 816
10	Screw-in nipple – 1/4", Ø 8 mm	265 136
11	Plug – Ø 8 mm	238 023

# Wearing part

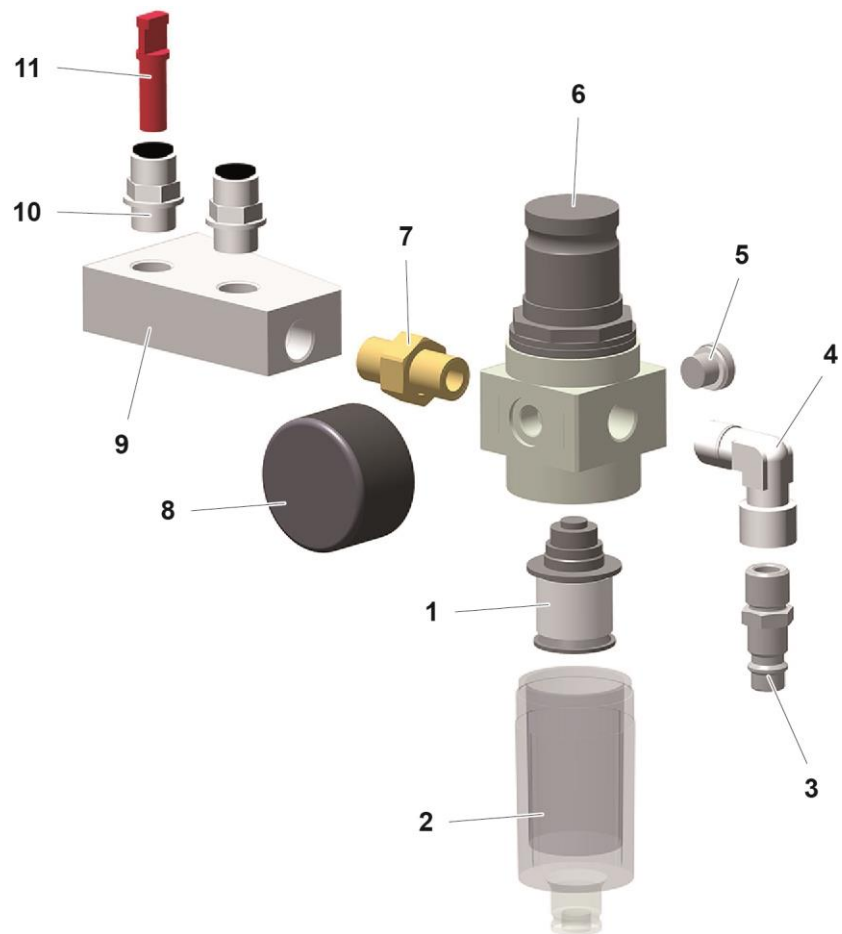

fig. 17: Pneumatic group

## PowerClean module set\*\*

	PowerClean module set – rinsing air hose length 2 m (pos. 1, 2, 3, 4 - 7)	1010 519
	PowerClean module set – rinsing air hose length 12 m (pos. 1, 2, 3.1 – 7)	1010 520
1	PowerClean module** – complete (See operating instructions OptiSelect Pro GM04 manual powder gun)	1009 528
2	Solenoid valve – complete	1009 928
3	PowerClean module cable – complete, length 1 m	1009 879
3.1	PowerClean module cable – complete, length 15 m	1009 880
4	Quick release connection – NW5-Ø 8 mm	1008 027
5	Plastic tube – Ø 8/6 mm, black	103 152*
6	O ring – Ø 16x2 mm, NBR70, anti-static (2x) (not shown)	#
7	Cable tie (not shown)	

\* Please indicate length

# Wearing part

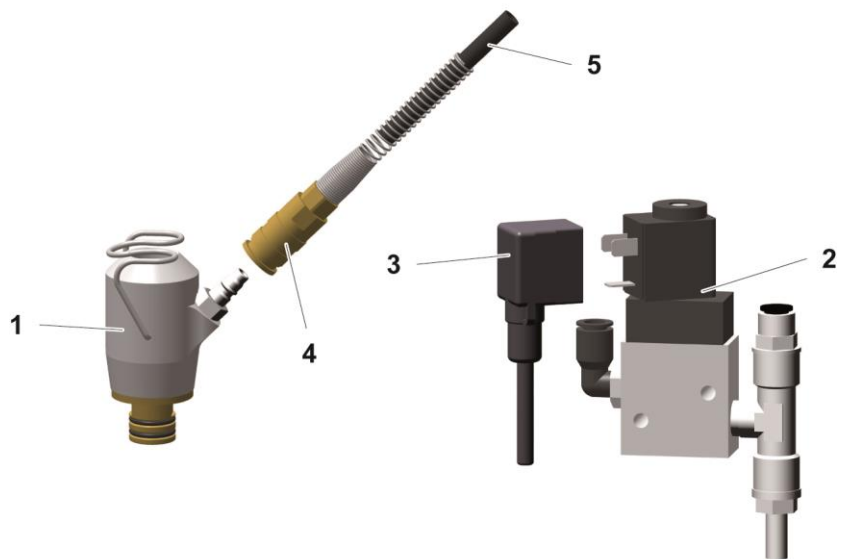

fig. 18: PowerClean module set\*\*

## OptiStar CG21 Gun control unit

	OptiStar CG21 gun control unit – complete, without item 4	1015 203
1	Front plate – complete, see corresponding spare parts list	
2	Enclosure	
3	Backplate – complete, see corresponding spare parts list	
4	Cover	1015 249

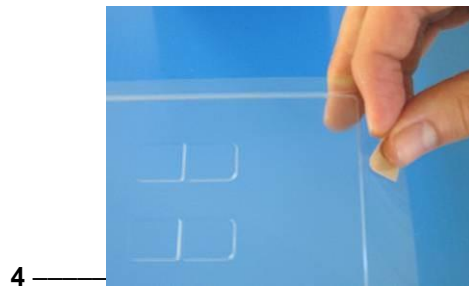

fig. 19

## Front plate and power pack

	Front plate – complete (pos. 1-12)	1015 219
	Front plate with foil keyboard (pos. 5-8)	1015 218
1	OptiStar Mainboard – complete	1015 221
2	Spacer sleeve – Ø 3.1/6x15 mm	
3	PCB "Powerboard" – complete	1015 223
4	Spacer sleeve – Ø 3.2/6x7 mm	
5	Front frame – complete (incl. pos. 5.1)	1015 232
5.1	Screw	1007 019
6	Screw – M4x16 mm	1013 925
7	Front plate gasket	1015 236
8	Membrane keypad	
9	Spacer sleeve – Ø 3.6/7x5 mm	
10	Display	1015 220
11	Washer – Ø 3.2/7x0.5 mm	
12	Locknut – M3	
13	Power pack – 24 VDC	1009 849

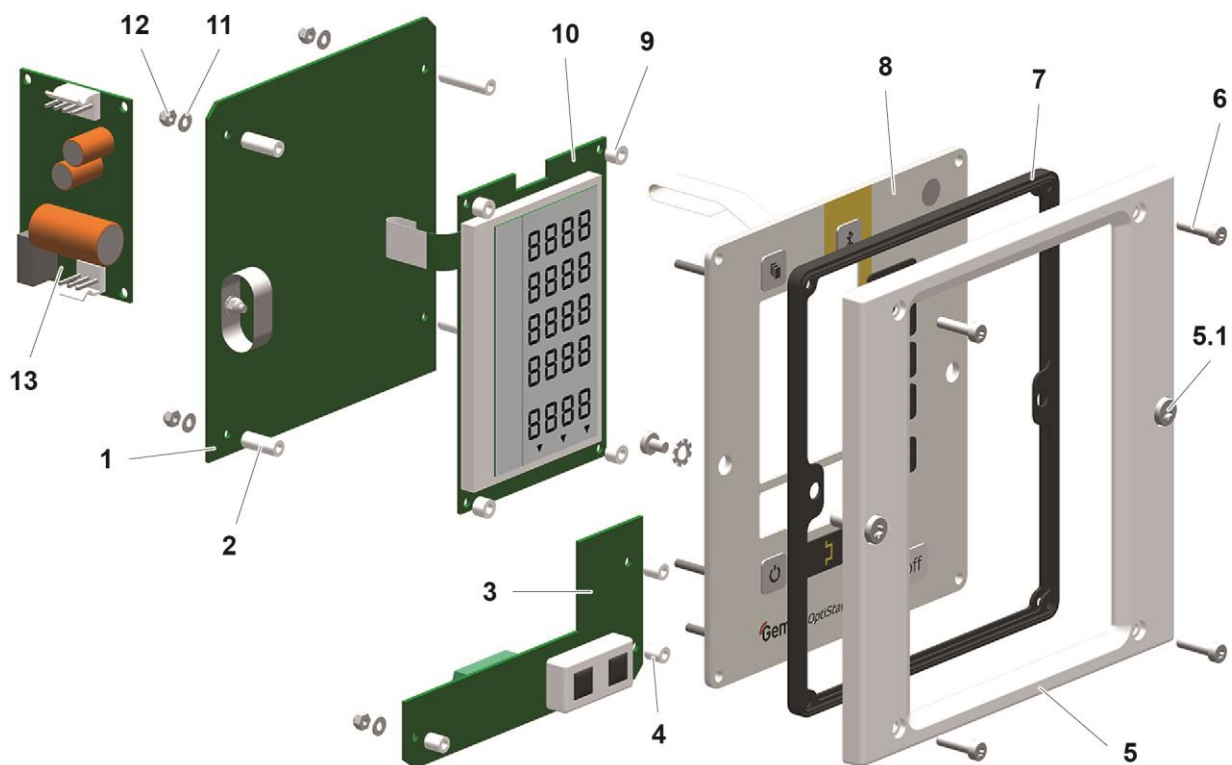

Fig. 20

---

## Inside back plate

---

1	Back plate gasket	1015 198
2	Elbow joint – 1/8"-Ø 8 mm	251 372
3	T-piece – 1/4"- Ø 8 - Ø 8 mm	1008 040
4	Solenoid valve – Ø 8-Ø 8 mm, 24 VDC	1003 914
5	O-ring – Ø 12x1.5 mm, NBR70	261 416
6	Motor throttle – complete	1000 064
7	O-ring – Ø 8x4 mm, NBR70	1001 521
8	Fluidizing pad – 1/8"	237 264
9	Screw – M4x16 mm	1013 925
10	Plastic tube – Ø 8/6 mm	103 152*
11	Motor throttle – complete	1008 012

\* Please indicate length



## Inside back plate

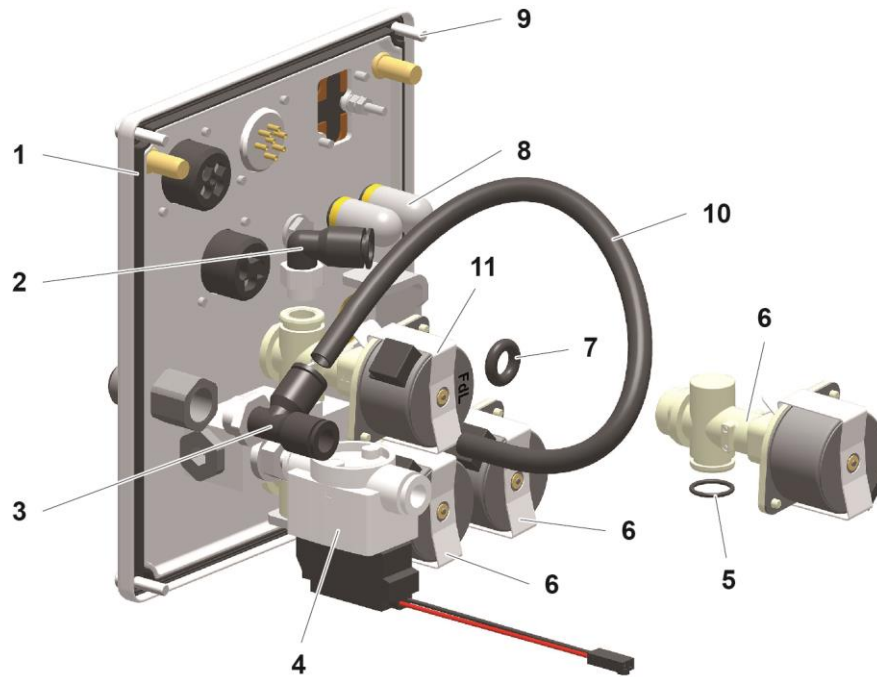

fig. 21: OptiStar CG21

## Connecting material

1	Quick release connection – NW5, Ø 6 mm	200 840
1.1	Hose – Ø 6/4 mm	100 854*
2	Nut with kink protection – M12x1 mm, Ø 8 mm	201 316
2.1	Supplementary air hose – Ø 8/6 mm (black)	103 756*
2.2	Quick release coupling for supplementary air hose – NW5-Ø 8 mm	261 637
3	Nut with kink protection – M12x1 mm, Ø 8 mm	201 316
3.1	Conveying air hose – Ø 8/6 mm (red)	103 500*
3.2	Quick release coupling for conveying air hose – NW5-Ø 8 mm	261 645
4	Quick release connection – NW5-Ø 8 mm	203 181
4.1	Hose – Ø 8/6 mm	103 756*
5	Quick release connection – NW 5-Ø 6 mm	200 840
5.1	Hose – Ø 6/4 mm	100 854*
6	Vibrator cable (constituent part of vibrator)	
8	PowerClean module cable – 1 m (option)	1009 879
	PowerClean module cable – 15 m (option)	1009 880
9	Mains cable – CH	382 493
	Mains cable – Schuko	382 485
	Mains cable – USA	382 507
	Mains cable – GB	382 515
	Mains cable – AUS	382 523
	Mains cable – China	1000 993

\* Please indicate length

## Connecting material

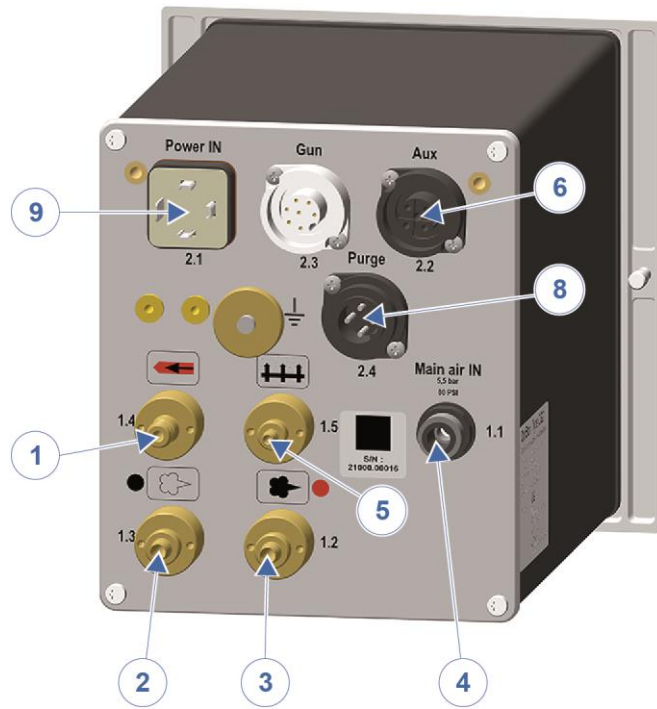

fig. 22

## OptiSelect Pro GM04 – spare parts list



**Only parts were included in the spare parts list, which the user can replace himself without problems!**

- ▶ If the powder gun cable is defective, it is to be completely sent in for repair!

<b>A</b>	OptiSelect Pro GM04 manual powder gun – complete incl. flat jet nozzle, brush and parts kit, without powder hose, with:	
	gun cable 6 m, rinsing air hose 6 m, negative polarity (–)	1016 971
	gun cable 12 m, rinsing air hose 12 m, negative polarity (–)	1016 972
	gun cable 6 m, rinsing air hose 6 m, positive polarity (+)	1016 973
	gun cable 12 m, rinsing air hose 12 m, positive polarity (+)	1016 974
<b>B</b>	Manual powder gun shaft OptiSelect Pro GM04 (incl. cascade) with:	
	Gun cable 6 m, negative polarity (–)	1018 700
	Gun cable 12 m, negative polarity (–)	1018 701
	Gun cable 6 m, positive polarity (+)	1018 702
	Gun cable 12 m, positive polarity (+)	1018 703
1	Gun body – complete	1017 680
2	Cascade – complete, negative polarity, incl. pos. 3	1016 911
	Cascade – complete, positive polarity, incl. pos. 3	1016 912
3	Buffer	1017 704
4	Print holder – complete	1017 690
5	Rear part	1017 683
6	Trigger – complete	1017 686
7	Trigger cover	1017 688
8	Countersunk-head screw – M4x6 mm	1017 698
9	SuperCorona connection	1017 684
10	Gun cable 2 m – complete	1016 951
	Gun cable 6 m – complete	1016 952
	Gun cable 12 m – complete	1016 953
11	Rinsing air connection	1017 656
11.1	Rinsing air hose	100 854*
12	Powder tube – complete	1007 958 #
13	Compression spring	1001 488
14	Clip ring	1007 960
15	Hose connection Ø 11-12 mm – complete (incl. pos 15.1)	1001 340 #
	Hose connection Ø 9-10 mm – complete (incl. pos 15.1)	1002 030 #
15.1	O-ring for pos. 15	1000 822 #
16	Threaded sleeve (see corresponding spare parts list)	
17	Nozzle (see corresponding spare parts list)	
18	Cable lock	1017 685
19	Screw – M3x20 mm	1017 674
20	Contact strip	1018 707

Cleaning brush – Ø 12 mm (not shown)	389 765
<b>Parts set (not shown), consisting of:</b>	<b>1008 302</b>
Multi-spray adapter	1003 634#
Cable clamp	303 070
Hose connector – complete, for hose interior Ø 9-10 mm	1002 030
Powder hose – Ø 10 mm (not shown)	1001 673*#
Powder hose – Ø 11 mm (not shown)	105 139*#



fig. 23: OptiSelect Pro GM04 – spare parts

## PowerClean™ module (Option)

	PowerClean module – complete	1009 528
1	Elastomer valve	1000 089#
2	O ring – Ø 16x2 mm, anti-static	1007 794#
3	Fluidizing tube bearing	1007 356
4	Fluidizing tube	1007 355
5	Retaining bracket	1009 524
6	Gasket	1010 101
7	O-ring – Ø 27x2 mm	1009 525

# Wearing part

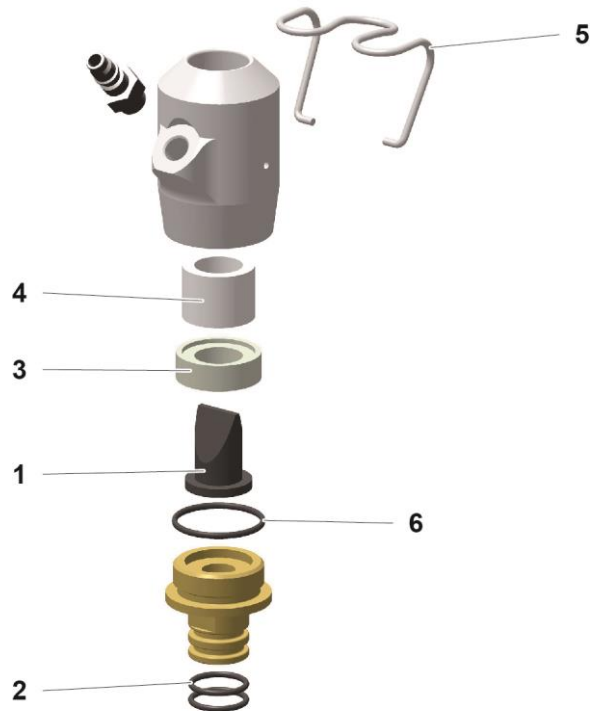

fig. 24

---

# SuperCorona

---

1	SuperCorona PC..	1018 291#
---	------------------	-----------

---

# Wearing part

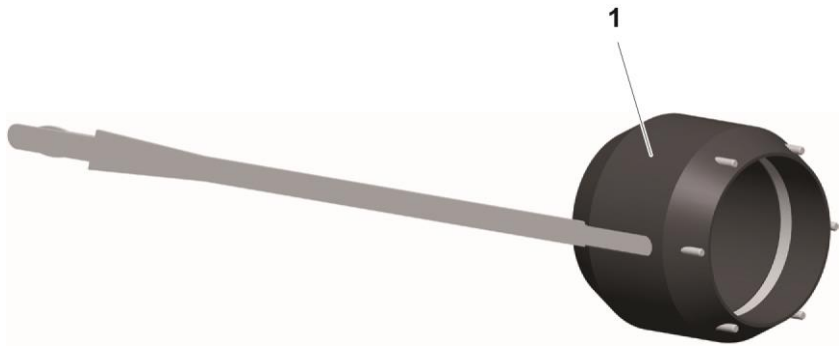









fig. 25

## Accessories





### Flat jet nozzles – overview (wearing parts)

Application	A	B	A + B	Threaded sleeve
Profiles/flat parts	 NF20 1010 090		<b>NF20</b> 1010160	 1007 229
Profiles/flat parts	 NF27 1010 752		<b>NF27</b> 1010 754	
Complex profiles and depressions	 NF21 1007 935	 1007 683	<b>NF21</b> 1007 932	
Complex parts (deep recess); target spraying	 NF22 1008 145		<b>NF22</b> 1008 140	
Profiles/big flat parts (standard nozzle)	 NF40* 1018 165		<b>NF40</b> 1018 166	
Large surfaces	 NF24* 1008 147		<b>NF24</b> 1008 142	









\* not suitable for angled nozzles



### Round jet nozzles – overview (wearing parts)

Application	A	B	A + B	Threaded sleeve	Deflectors
Suitable for large surfaces	 NS04 1008 151	 1008 152	<b>NS04</b> 1008 150	 1007 229	
					Ø 16 mm 331 341
					Ø 24 mm 331 333
					Ø 32 mm 331 325

## Gun extensions

Gun extensions		
	L = 150 mm	L = 300 mm
without nozzle <sup>1</sup>	 1008 616	 1008 617
without nozzle <sup>2</sup>	 1007 718	 1007 719
with Flat jet nozzle NF25	 1007 746	 1007 747
with Round jet nozzle NS09	 1007 748	 1007 749

<sup>1</sup> see NF27, NF20, NF21, NF24, NS04

<sup>2</sup> see NF25, NF26, NS09

### ATTENTION

#### Connecting more than two extensions

It is not permitted to connect more than two extensions together, in order to prevent the gun from being damaged by arising leverage force.

- ▶ The extensions (150 mm/300 mm) may be connected TO ONLY ONE ADDITIONAL extension (150 mm/300 mm), if necessary.

### Spray nozzles for extensions – overview (wearing parts)



1007 718



1007 719



Application	A	B	A + B	Threaded sleeve	Deflectors
Profiles/flat parts	 NF25 1007 735	 1007 684	<b>NF25</b> 1007 743	 1007 740	--
Complex profiles and depressions	 NF26 1007 742	 1007 684	<b>NF26</b> 1007 744		--
Suitable for large surfaces	 NS09 1008 257	 1008 258	<b>NS09</b> 1008 259		 Ø 16 mm 331 341 Ø 24 mm 331 333 Ø 32 mm 331 325

## Powder hoses – overview

Powder hose (antistatic)	Application	Diameter	Parts No.*	Material	Type
 <p>                     Ø 12/ 18 mm Typ 75 Material POE                 </p> <p>                     Ø 11/ 16 mm Typ 66 Material POE                 </p> <p>                     Ø 10/ 15 mm Typ 74 Material POE                 </p>	Fast color changes	Ø 11/16 mm	105 139	POE	66
	Fast color changes - low powder flow	Ø 10/15 mm	1001 673	POE	74
	Fast color changes - high powder flow	Ø 12/18 mm	1001 674	POE	75

\* Please indicate length

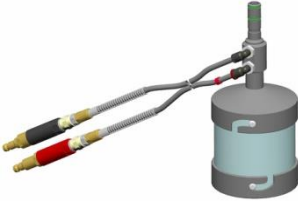
## Other accessories

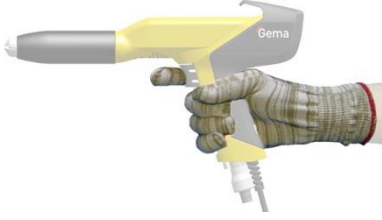
Application cup	<p>150 ml</p>  <p>1004 552</p>	<p>500 ml</p>  <p>1002 069</p>
Gun extension cables	 <p>L=6 m 1002 161</p>	
Gloves, anti-static (1 pair)	 <p>800 254</p>	

## OptiFlow IG07 – Spare parts list

	OptiFlow IG07 Powder injector – complete (pos. 1-15)	1015 100
<b>A</b>	Conveying air check valve unit (red marking) – complete (incl. pos. 6, 8, 9 and 10)	1015 830
<b>B</b>	Supplementary air check valve unit (black marking) – complete (incl. pos. 7, 8, 9 and 11)	1015 831
1	Injector body – without pos. 14 and 15	1015 102
2	Slide gate	1015 104
3	Release trigger	1014 810
4	Screw – M3x6 mm	1014 812
5	Compression spring	1014 813
6	Connector (conveying air) – NW 5.5	1004 366
7	Connector (supplementary air) – NW 5.5	1004 367
8	O-ring – Ø 11x1.5 mm	1000 532
9	Filter element	1015 832
10	Body (red)	1015 835
11	Body (black)	1015 836
12	Cartridge – complete	1016 561#
13	Hose connection – complete	1014 806
14	O-ring – Ø 16x2 mm	1007 794#
15	Axial gasket – complete	1014 814
21	Conveying air hose – Ø 8/6 mm (red)	103 500*
22	Supplementary air hose – Ø 8/6 mm (black)	1008 038*
23	Quick release coupling for conveying air hose – NW5-Ø 8 mm	261 645
24	Quick release coupling for supplementary air hose – NW5-Ø 8 mm	261 637
25	Kink protection	1008 844
	Powder hose – 66 type, POE, Ø 16/11 mm, with conductive strip (standard)	105 139*#
	Powder hose – 74 type, POE, Ø 15/10 mm, with conductive strip	1001 673*#
	Powder hose – 75 type, POE, Ø 18/12 mm, with conductive strip	1001 674*#

\* Please indicate length

# Wearing part

# OptiFlow IG07 – spare parts

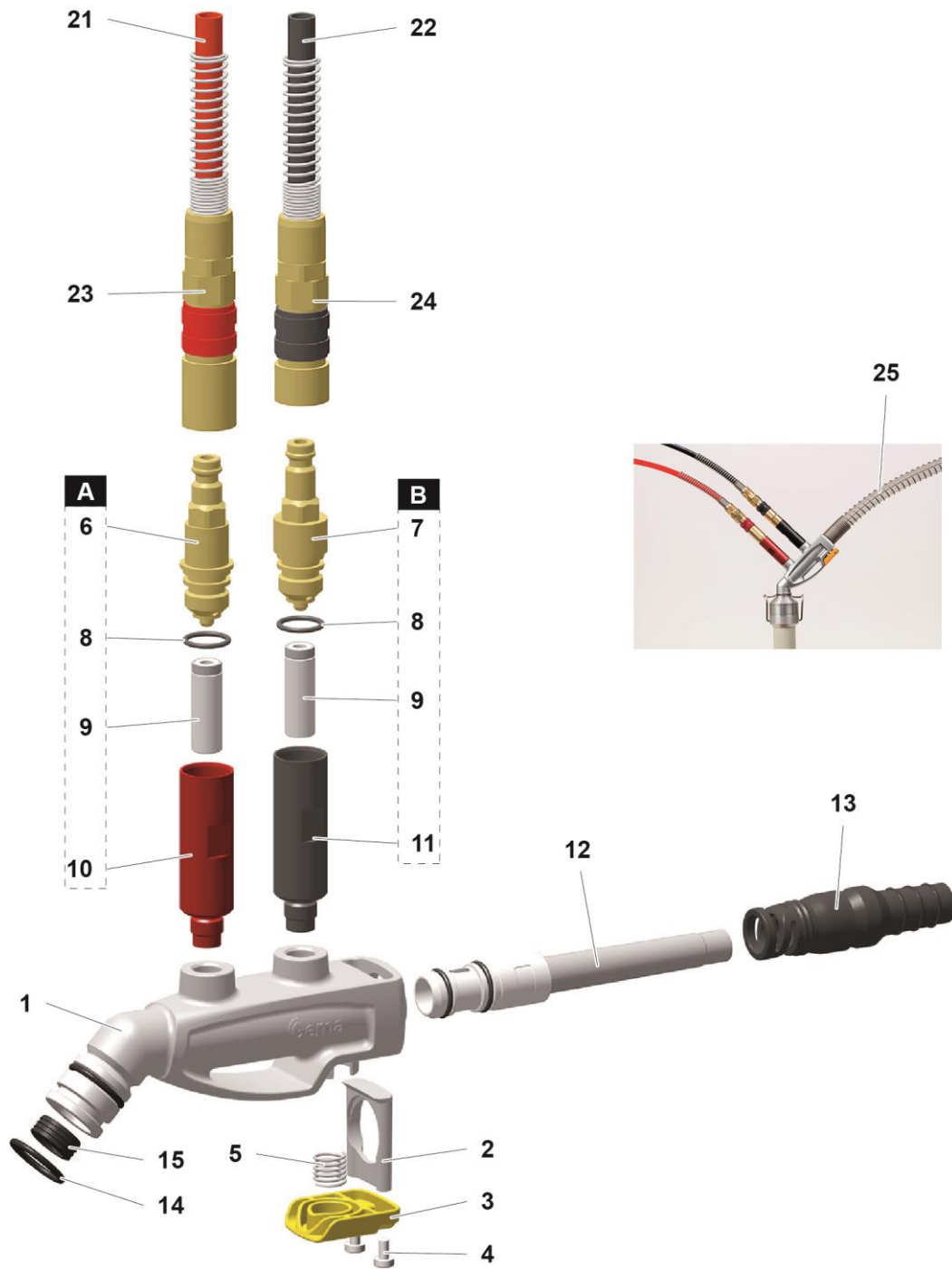

fig. 26

# Index

## A

About these instructions.....	5
Assembly.....	21

## B

Basic safety instructions.....	7
--------------------------------	---

## C

Cleaning.....	39, 59
Connectable guns.....	17
Connection.....	21

## D

Decommissioning.....	35
Design and function.....	43
Dimensions.....	18
Disuse for several days.....	35

## E

Electrical data.....	17, 53
Environmental conditions.....	19

## F

Fault clearance.....	41, 47, 55, 63
Figure references in the text.....	6

## I

Input keys and switches.....	45
Intended use.....	13

## M

Maintenance.....	37, 59
------------------	--------

## O

Operating elements.....	44
Displays.....	44
Input keys and switches.....	45
Operation.....	25
Overall view.....	43

## P

Pictograms.....	5
Pneumatic data.....	17
Powder output (reference values).....	18
PowerClean™ module.....	15
Presentation of the contents.....	6
Product specific security regulations.....	8

## R

Rating plate.....	20
Repairs.....	37, 59

## S

Safety.....	7
Safety symbols.....	5
Sound pressure level.....	20
Spare parts list.....	65
Start-up.....	23
Storage.....	35

## T

Technical Data.....	53
---------------------	----

