Operating instructions and spare parts list

Manual coating equipment

OptiFlex 2 L



Translation of the original operating instructions

Documentation OptiFlex 2 L

© Copyright 2010 ITW Gema GmbH

All rights reserved.

This publication is protected by copyright. Unauthorized copying is prohibited by law. No part of this publication may be reproduced, photocopied, translated, stored on a retrieval system or transmitted in any form or by any means for any purpose, neither as a whole nor partially, without the express written consent of ITW Gema GmbH.

OptiTronic, OptiGun, EasyTronic, EasySelect, OptiFlow and SuperCorona are registered trademarks of ITW Gema GmbH

OptiMatic, OptiMove, OptiMaster, OptiPlus, PowerClean, Precise Charge Control (PCC), OptiSpray, MultiTronic and Gematic are trademarks of ITW Gema GmbH.

All other product names are trademarks or registered trademarks of their respective holders.

Reference is made in this manual to different trademarks or registered trademarks. Such references do not mean that the manufacturers concerned approve of or are bound in any form by this manual. We have endeavored to retain the preferred spelling of the trademarks, and registered trademarks of the copyright holders.

To the best of our knowledge and belief, the information contained in this publication was correct and valid on the date of publication. ITW Gema GmbH makes no representations or warranties with respect to the contents or use of this publication, and reserves the right to revise this publication and make changes to its content without prior notice.

Printed in Switzerland

ITW Gema GmbH
Mövenstrasse 17
9015 St.Gallen
Switzerland

Phone: +41-71-313 83 00

Fax.: +41-71-313 83 83

E-Mail: info@itwgema.ch

Homepage: www.itwgema.ch

Table of contents

General safety regulations	3
Safety symbols (pictograms).....	3
Conformity of use.....	8
Product-specific safety measures.....	8
OptiFlex 2 L Manual coating equipment	8
About this manual	9
General information	9
Product description	11
Field of application	11
Utilization.....	11
Reasonably foreseeable misuse.....	12
Technical data.....	12
Connectable guns	12
Powder output (guide values)	12
Guide values for OptiFlex 2 CG09 with the OptiFlow IG06 injector.....	13
Air flow rates	13
Electrical data	13
Pneumatic data	14
Dimensions	14
Processible powders.....	14
Design and function	15
General view	15
Scope of delivery	16
OptiFlex 2 L.....	16
Typical properties - Characteristics of the functions.....	16
Processing of the powder from the fluidized powder container	16
Start-up	17
Preparation for start-up	17
Basic conditions	17
Set-up.....	17
Mounting instructions	18
Connection instructions.....	18
Initial start-up	21
Setting the device type.....	22
Operation	23
Coating.....	23
Setting the background illumination	26
Color change.....	27
General information	27
Shutdown	29

Cleaning and maintenance	31
Daily maintenance	31
Weekly maintenance	31
If in disuse for several days	31
Powder hose rinsing	31
Cleaning	32
Cleaning the powder container	32
Cleaning the OptiFlex 2 GM03 manual powder gun	32
Maintenance and cleaning of the filter unit	33
Replacing the filter element	33
 Troubleshooting	 35
General information	35
 Spare parts list	 37
Ordering spare parts	37
OptiFlex 2 L manual coating equipment - Spare Parts	38
OptiFlex 2 L manual coating equipment - Spare parts	39
OptiFlex 2 L - Pneumatic group	40

General safety regulations

This chapter sets out the fundamental safety regulations that must be followed by the user and third parties using OptiFlex 2 L manual coating equipment.

These safety regulations must be read and understood in full before the OptiFlex 2 L is put into operation.

Safety symbols (pictograms)

The following warnings with their meanings can be found in the ITW Gema operating instructions. The general safety precautions must also be followed as well as the regulations in the operating instructions.

**DANGER!**

danger due to live electricity or moving parts. Possible consequences: death or serious injury

**WARNING!**

improper use of the equipment could damage the machine or cause it to malfunction. Possible consequences: minor injuries or damage to equipment

**INFORMATION!**

Useful tips and other information



General information

The OptiFlex 2 L manual coating equipment is state of the art equipment that conforms to the recognized technical safety regulations and is designed for normal powder coating applications.

Any other use is considered non-compliant. The manufacturer shall not be liable for damage resulting from such use; the user bears sole responsibility for such actions. ITW Gema GmbH must be consulted before OptiFlex 2 L manual coating equipment is used for any other purposes or substances beyond those indicated here.

Observance of the operating, service and maintenance instructions specified by the manufacturer is also part of conformity of use.

The relevant accident prevention regulations, as well as other generally recognized safety regulations, occupational health and structural regulations are to be observed.

Furthermore, the country-specific safety regulations also must be observed.

Additional safety and operation notices can be found on the accompanying CD or on the homepage www.itwgema.ch.



General dangers

Start-up is forbidden until it has been established that the OptiFlex 2 L manual coating equipment has been set up and wired according to the EU guidelines for machinery.

Unauthorized modifications to the OptiFlex 2 L Manual coating equipment exempts the manufacturer from any liability from resulting damages or accidents.

The operator must ensure that all users have received appropriate training for powder spraying equipment and are aware of the possible sources of danger.

Any operating method, which will negatively influence the technical safety of the powder spraying equipment, is to be avoided.

For your own safety, only use accessories and attachments listed in the operating instructions. The use of other parts can lead to risk of injury. Only original ITW Gema spare parts should be used!

Repairs must only be carried out by specialists or by authorized ITW Gema service centers. Unauthorized conversions and modifications can lead to injuries and damage to the equipment and invalidate the ITW Gema GmbH guarantee.



Electrical
danger

The connecting cables between the control unit and the spray gun must be installed so as to eliminate the possibility of damage during the operation. Please observe the local safety regulations!

The plug connections between the powder spraying equipment and the mains should only be removed when the power supply is switched off.

All maintenance activities must take place when the powder spraying equipment is switched off.

The powder coating equipment may not be switched on until the booth is in operation. If the booth stops, the powder coating device must switch off too.



Explosion hazard

The control units for the spray guns must be installed and used in zone 22. Spray guns are allowed in zone 21.

Only original ITW Gema OEM parts are guaranteed to maintain the explosion protection rating. If damages occur related to the use of spare parts from other manufacturers, all relevant warranty or compensation claims are void!

Conditions leading to dangerous levels of dust concentration in the powder spraying booths or in the powder spraying areas must be avoided. There must be sufficient technical ventilation available, to prevent a dust concentration of greater than 50% of the lower explosion limit (UEG = max. permissible powder/air concentration). If the UEG is not known, then a value of 10 g/m³ should be considered (see EN 50177).

All unauthorized conversions and modifications to the electrostatic spraying equipment are forbidden for safety reasons.

The safety devices may not be dismantled or put out of operation.

Mandatory operational and workplace notices from the operating company must be written in a comprehensible manner in the language of equipment operators and posted in a suitable place.



Slip hazard

Powder lying on the floor around the powder spraying equipment is a potentially dangerous source of slipping. Booths may be entered only in the places designed for this purpose.

Static charges

Static charges can have the following consequences: Charges to people, electric shocks, sparking. Proper grounding must be in place to prevent objects from becoming charged.



Observe the grounding regulations

Grounding

All electrically conductive parts found within 5 meters around each booth opening, and in particularly the objects to be coated, must be grounded. The grounding resistance of each object must amount to maximally 1 MOhm. This resistance must be checked/tested regularly when starting work.

The condition of the work piece attachments, as well as the hangers, must guarantee that the work pieces remain grounded. The appropriate measuring devices must be kept ready in the workplace, in order to check the grounding.

The floor of the coating area must conduct electricity (normal concrete is generally conductive).

The supplied grounding cable (green/yellow) must be connected to the grounding screw of the electrostatic manual powder coating equipment. The grounding cable must have a good metallic connection with the coating booth, the recovery unit and the conveyor chain, respectively with the suspension arrangement of the objects.



Fire and smoke prohibition

Smoking and igniting fire are forbidden in the entire vicinity of the system! No work that could potentially produce sparks is allowed!



The stay for persons with cardiac pacemakers is forbidden

As a general rule for all powder spraying installations, persons with pacemakers should never enter high voltage areas or areas with electromagnetic fields. Persons with pacemakers should not enter areas with powder spraying installations!



Photographing with flashlight is forbidden

Photographing with flashlight can lead to unnecessary releases and/or disconnections by safety devices.



Disconnect from mains before maintenance works take place

Disconnect the plugs before the machines are opened for maintenance or repair.

The plug connections between the powder spraying equipment and the mains should only be removed when the power supply is switched off.



As far as it is necessary, the operating firm must ensure that the operating personnel wear protective clothing (e.g. facemasks).

The operating personnel must wear electrically conductive footwear (e.g. leather soles).

The operating personnel should hold the gun with bare hands. If gloves are worn, these must also conduct electricity.

These general safety regulations must be read and understood in all cases prior to start-up!

Conformity of use

1. The OptiFlex 2 L manual coating equipment is state of the art equipment that conforms to the recognized technical safety regulations and is designed for normal powder coating applications.
2. Any other use is considered non-compliant. The manufacturer shall not be liable for damage resulting from such use; the user bears sole responsibility for such actions. ITW Gema GmbH must be consulted before OptiFlex 2 L manual coating equipment is used for any other purposes or substances beyond those indicated here.
3. Observance of the operating, service and maintenance instructions specified by the manufacturer is also part of conformity of use. The OptiFlex 2 L manual coating equipment should only be used, maintained and started up by trained personnel informed and familiar with the possible hazards involved.
4. Start-up (i.e. operation of its intended use) is not allowed until it has been established that the OptiFlex 2 L manual coating equipment has been installed and wired according to the EU Machinery Directive (2006/42/EC). EN 60204-1 (machine safety) must also be observed.
5. Unauthorized modifications to the OptiFlex 2 L manual coating equipment exempts the manufacturer from any liability from resulting damage.
6. The relevant accident prevention regulations, as well as other generally recognized safety regulations, occupational health and structural regulations are to be observed.
7. Furthermore, the country-specific safety regulations also must be observed.

Product-specific safety measures

- Installation work performed by the customer must be carried out according to local regulations.
- All components must be grounded according to the local regulations before start-up.

OptiFlex 2 L Manual coating equipment

The OptiFlex 2 L manual coating equipment is a constituent part of the equipment and is therefore integrated in the system's safety concept.

If it is to be used in a manner outside the scope of the safety concept, then corresponding measures must be taken.



Note:

For further security information, see the more detailed ITW Gema safety regulations!

About this manual

General information

This operating manual contains all important information required to work with the OptiFlex 2 L manual coating equipment. It will safely guide you through the start-up process and give you references and tips for the optimal use of your new powder coating system.

Information about the functionality of the individual system components - booth, gun control unit, manual gun or powder injector - should be referenced to their enclosed corresponding documents.

Product description

Field of application

The OptiFlex 2 L manual coating equipment (with powder hopper) is exclusively intended for electrostatic coating using organic powders (For more on this please also review chapter "Technical Data").

Any other use is considered non-compliant. The manufacturer is not responsible for any incorrect use and the risks associated with such actions are assumed by the user alone!

For a better understanding of the interrelationships in powder coating, it is recommended that the operating instructions for all other components be read as well, so as to be familiar with their functions too!



OptiFlex 2 L Manual coating equipment

Utilization

The electrostatic OptiFlex 2 L manual coating equipment with the OptiFlex 2 GM03 manual powder gun is ideally suited for manual coating of objects.

Reasonably foreseeable misuse

- Operation without the proper training
- Use with insufficient compressed air quality and grounding
- Use in connection with unauthorized coating devices or components

Technical data

Connectable guns

OptiFlex 2 L	connectable
OptiFlex 2 GM03	yes
OptiSelect GM02	contact Gema
OptiGun GA02	contact Gema
PG3-E**	contact Gema
TriboJet*	yes

* The gun type must be configured (For more on this, please see the operating instructions for the OptiFlex 2 CG09 manual gun control unit). The Tribo gun the gun is not type approved (ATEX).

** Only for enamel powder, the gun is not type approved (ATEX).

*** Combination is not type approved (ATEX).



Warning:

The OptiFlex 2 L manual coating equipment can only be used with the specified gun types!



Powder output (guide values)

General conditions for the OptiFlow Injector

Powder type	Epoxy/polyester
Powder hose length (m)	6
Powder hose Ø (mm)	10
Powder hose type	POE with guide strips
Input pressure (bar)	5,5
Conveying air nozzle Ø (mm)	1,6
Correction value C0	Powder output zeroing adjustment

Guide values for OptiFlex 2 CG09 with the OptiFlow IG06 injector

All values in these tables are guide values. Differing environmental conditions, wear and different powder types can affect the table values.

Total air 		3 Nm ³ /h	4 Nm ³ /h	5 Nm ³ /h
		Powder output (g/min)		
Powder output  (%)	20	85	100	120
	40	150	185	210
	60	210	255	280
	80	270	320	350
	100	300	360	395

Air flow rates

The total air consists of conveying air and supplementary air, in relation to the selected powder quantity (in %). As a result the total air volume is maintained constant.

OptiFlex 2 L	Range	Factory setting
Flow rate - fluidizing air - OptiFlex L	0-5.0 Nm ³ /h	1.0 Nm ³ /h
Electrode rinsing air flow rate	0-3.0 Nm ³ /h	0.1 Nm ³ /h
Flow rate total air (at 5.5 bar)	1.8-6.5 Nm ³ /h	



Note:

The total air consumption for the device is determined based on the 3 configured air values. These values apply for an internal control pressure of 5.5 bar!

Electrical data

OptiFlex 2 L	
Nominal input voltage	100-240 VAC
Frequency	50 -60 Hz
Connected load	40 VA
Nominal output voltage (to the gun)	eff. 10 V
Nominal output current (to the gun)	max. 1.2 A
Connection for rinsing function (valve)	24 VDC max. 3 W
Temperature range	0°C - +40°C (+32°F - +104°F)
Max. operating temperature	85°C (+185°F)
Approvals	pending

Pneumatic data

OptiFlex 2 L	
Max. input pressure	10 bar
Min. input pressure	6 bar
Input pressure (Dynamic based on pressure regulator setting)	5.5 bar / 80 psi
Max. water vapor content of the compressed air	1.3 g/m ³
Max. oil vapor content of the compressed air	0.1 mg/m ³
Max. compressed air consumption	11 Nm ³ /h

Dimensions

OptiFlex 2 L	
Width	654 mm
Depth	310 mm
Height	428 mm
Weight	16.5 kg

Processible powders

OptiFlex 2 L	
Plastic powder	yes
Metallic powder	yes
Enamel powder	no

Design and function

General view



OptiFlex 2 L manual coating equipment - Setup

- | | | | |
|---|-----------------------------------|----|-------------------|
| 1 | OptiFlex 2 CG09 control unit | 8 | Venting connector |
| 2 | OptiFlex 2 GM03 manual powder gun | 10 | Filter unit |
| 3 | OptiFlow injector | 11 | Gun holder |
| 4 | Base | 13 | PowerClean module |
| 7 | Fluidized powder hopper | 14 | Shelf |

OptiFlex 2 GM03 manual powder gun

All information about the OptiFlex 2 GM03 manual powder gun can be found in the documentation for that equipment (enclosed with this manual)!

OptiFlex 2 CG09 control unit

All information about the OptiFlex 2 CG09 manual gun control unit can be found in the documentation for that equipment (enclosed with this manual)!

OptiFlow injector

All information about the OptiFlow injector can be found in the corresponding enclosed documentation!

Scope of delivery

OptiFlex 2 L

- OptiFlex 2 CG09 control unit in a metal case with power supply cable
- Base with column and filter unit
- Fluidized powder hopper
- plug-in OptiFlow injector
- OptiFlex 2 CM03 manual powder gun with gun cable, powder hose, rinsing air hose and standard nozzle set (For more on this, see the operating manual for the OptiFlex 2 CM03 manual powder gun)
- Pneumatic hoses for conveying air (red), supplementary air (black), fluidizing air (black) and rinsing air (black)
- Operating manual
- Short instructions

Typical properties - Characteristics of the functions

Processing of the powder from the fluidized powder container

The OptiFlex 2 L manual coating equipment processes powder from the fluidized powder container.

Start-up

Preparation for start-up

Basic conditions

When starting up the OptiFlex 2 L manual coating unit, the following general conditions impacting the coating results must be taken into consideration:

- Manual coating equipment is set up properly
- Gun control unit correctly connected
- Gun correctly connected
- Corresponding power and compressed air supply available
- Powder preparation and powder quality

Set-up

The OptiFlex 2 L manual coating equipment should always be set up vertically on a flat surface.



WARNING

The manual coating equipment must not under any circumstances be set up near a heat source (such as an enameling furnace) or an electromagnetic source (such as a control cabinet).

Mounting instructions

The OptiFlex 2 L manual coating equipment must be set up in accordance with the setup and connecting instructions (included with delivery).



OptiFlex 2 L Manual coating equipment

Connection instructions

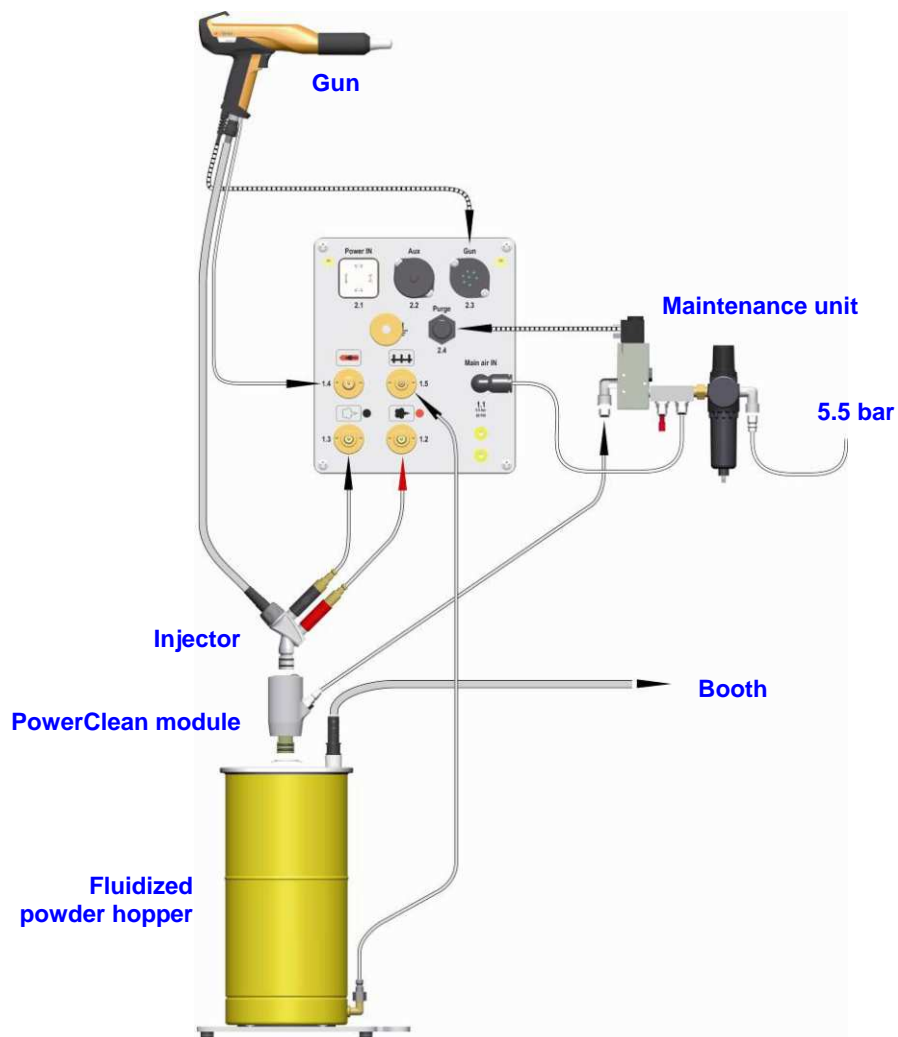

Connection instructions - overview

The OptiFlex 2 L manual coating equipment must be connected in accordance with the setup and connection instructions (Please also review the operating instructions for the OptiFlex 2 CG09 manual gun control unit).

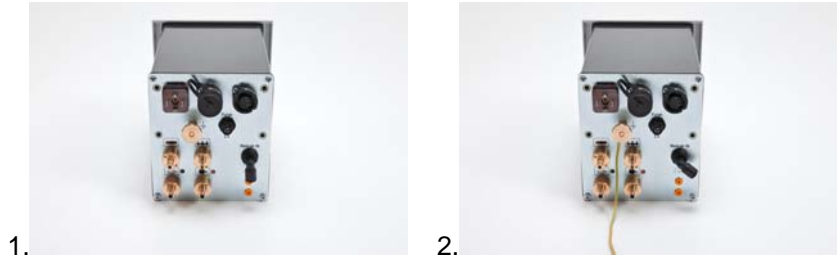

1.

2.



Note:

Use clamp to connect grounding cable to the cabin or the suspension arrangement. Check ground connections with Ohm meter and ensure 1 MOhm or less!

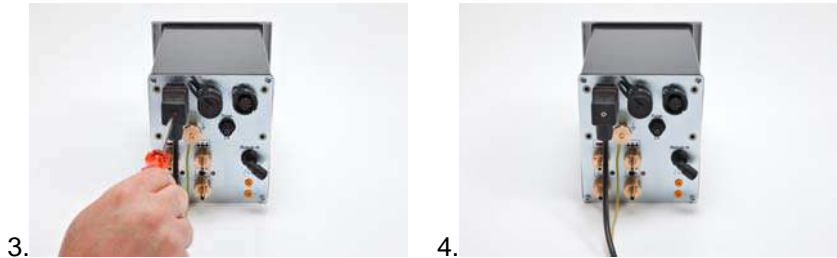

3.

4.

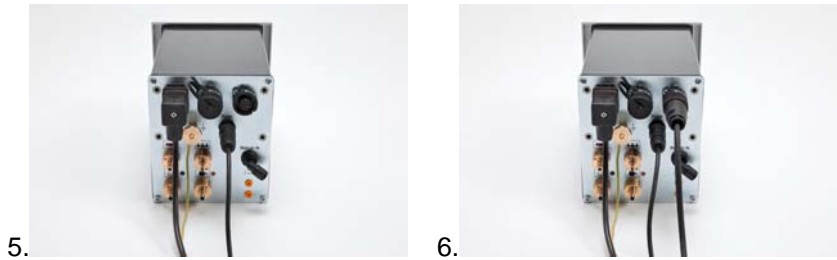

5.

6.

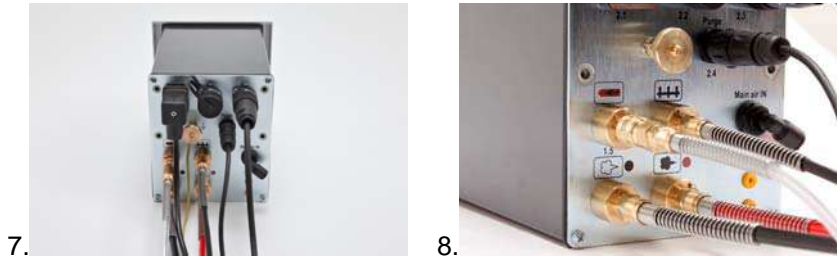

7.

8.

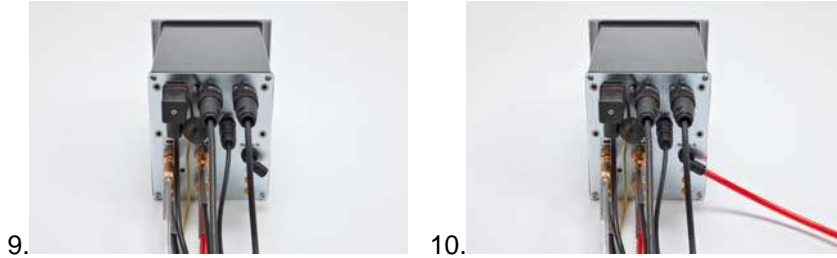

9.

10.



Note:

The compressed air must be free of oil and water!

Initial start-up



Note:

If a malfunction occurs, see the troubleshooting guide, as well as the gun control unit operating manual!

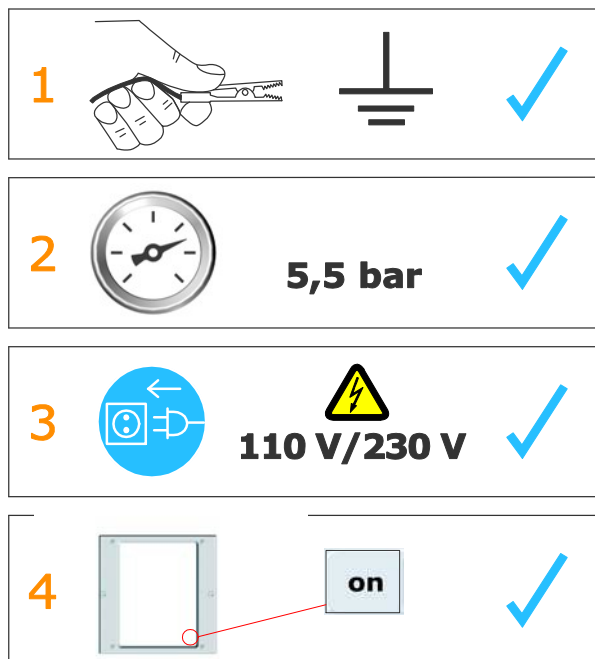

Note:

The remainder of the start-up procedure for the OptiFlex 2 GM03 manual powder gun is explicitly described in the operating instructions for the OptiFlex 2 CG09 manual powder gun control unit (chapter "Initial start-up" and "Daily start-up")!

Setting the device type



Note:

If the control unit is delivered as an integral component of an OptiFlex apparatus, then the system parameters will have been factory preconfigured for optimal use (For more on this, please also see the operating instructions for the OptiFlex 2 CG09 manual gun control unit!).



NOTE!

The manual gun control unit always starts up to the last configured settings.

Operation

Coating

1. Turn on the gun control unit with the **ON** key
The displays illuminate and the control unit is ready for operation
2. Swivel aside the fluidizing/suction unit
3. Place the open powder container on the vibrating table
4. Place the fluidizing/suction unit onto the powder
5. Set coating parameters:
6. Press the application button for the appropriate preset mode:

flat parts	
complicated parts	
overcoat	

The arrow above the desired button lights up



OR

7. Press program key
 - a) Select desired program (01-20)

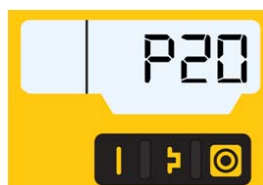

- b) Change coating parameters as required



Note:

Programs 01-20 are preset at the factory but can be modified at any time, after which they are automatically stored.

Description	Presetting
Powder output	50%
Total air	4.0 Nm ³ /h
High voltage kV	80 kV
Spray current μA	80 μA
Electrode rinsing air	0.1 Nm ³ /h
Fluidizing air	1.0 Nm ³ /h (for OptiFlex-F)

8. Setting the total air volume

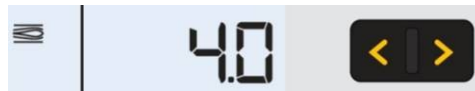

correct powder cloud

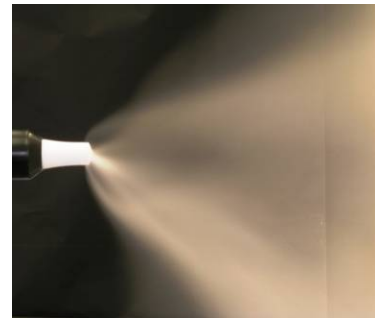

too little total air



Note:

A total air volume of 4 Nm³/h and a 50% powder share are recommended as the base values.

9. Adjust the powder output volume (e.g. according to the desired coating thickness)



much powder



little powder



Note:

To achieve maximum efficiency, we recommend avoided an overly high powder volume where possible! The standard setting of 50% and a total air volume of 4 Nm³/h is recommended at the start. The total air volume is thereby kept constant automatically by the control unit.

If values are entered that the equipment cannot implement, then the operator is informed of this by a blinking in the relevant display and a temporary error message!

10. Setting the electrode rinsing air

- a) Press the key  The second display level will be shown

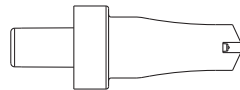

approx.
0.3 Nm³/h

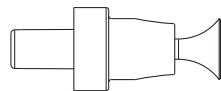

approx.
0.5 Nm³/h



too much electrode rinsing air

11. Setting the fluidization

- a) Press the key  The second display level will be shown



- c) Check the powder fluidization in the powder container
The powder fluidization in the powder containers depends on the powder characteristic, the humidity and the ambient air temperature. Fluidizing and vibration start by switching on the control unit.

12. Point the gun into the booth (not at the object to be coated), press the gun trigger and visually check the powder output
13. Check whether everything is functioning correctly
14. Coating
15. Adjust the coating parameters as necessary
16. Activate the rinsing function periodically

**Note:**

It prevents the bridging phenomena that can lead to short circuiting when handling powders such as metallic powders.

In moist or tropical environments, any moisture is driven from the injector, powder hose and powder gun.



- The LCD segments begin to move on the CG09 display



Note:
The PowerClean function can be stopped as required using the P key.



Procedure	Effect
automatic	<ul style="list-style-type: none"> - The automatic rinsing process is started - Injector, powder hose, gun and spray nozzle are purged using compressed air - The automated PowerClean function enables parallel cleaning of other components, such as the fluid intake unit, powder container, etc.
manual	<ul style="list-style-type: none"> - The operator controls the number and length of the PowerClean impulse by pressing the pistol trigger a second time

After completion of the PowerClean procedure, the controller switches back to coating mode.

Setting the background illumination

1. Press  key
The display switches to the following level:

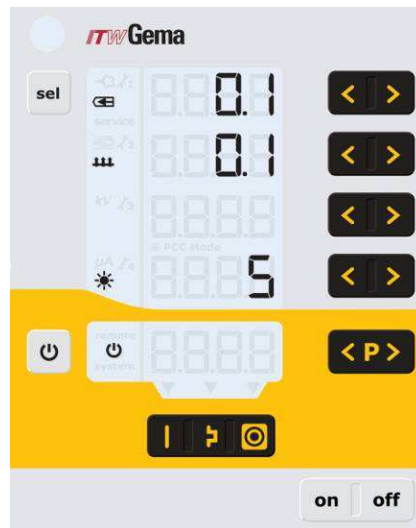







2. 
Select the desired brightness

Color change

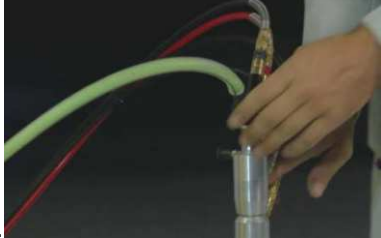
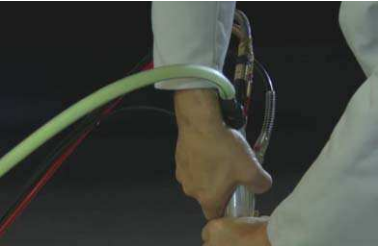
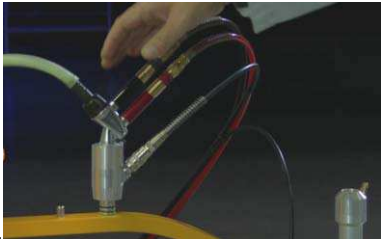
General information

When a color change takes place, the individual components of the manual coating equipment must be cleaned carefully. All powder particles of the former color must be removed during this process!

The following describes an 'extreme' color change (light to dark).

1. 
2. 
3. 
4. 
5. 
6. 
7. 
8. 
9. 
10. Remove and clean the nozzle, purge gun using air



15. Separate fluidized air cable
16. Remove cover, purge with compressed air and clean with a clean, dry brush and cloth
17. Clean suction intake pipe
18. Empty remaining powder into a container
19. Vacuum up container and in particular the bottom
20. Clean container with a cloth
21. Reconstruct the powder container
22. Fill with new powder





Shutdown



1. Release gun trigger
2. Switch off the control unit

Note:

The adjustments for high voltage, powder output, electrode rinsing air and fluidizing remain stored!

If in disuse for several days

1. Separate from power mains
2. Clean coating apparatus (see Chapter on "Cleaning and maintenance")
3. Turn off the compressed air main supply

Cleaning and maintenance



Note:

Regular and conscientious maintenance increases the service life of the OptiFlex 2 L manual coating equipment and provides for a longer continuous coating quality!

The parts, which are to be replaced during maintenance work, are available as spare parts. These parts will be found in the corresponding spare parts list!

Daily maintenance

1. Clean the injector (see therefore the user manual of the OptiFlow injector)
2. Clean the powder gun (For more on this, please also review the user manual for the OptiFlex 2 GM03 manual powder gun)
3. Clean the powder hose; Please also review the section "Color change"

Weekly maintenance

1. Clean powder container, injector, rinsing module and powder gun.
2. Check the control unit grounding connections to the coating booth, the suspension devices of the work pieces, or the conveyor chain

If in disuse for several days

1. Separate from power mains
2. Clean the coating equipment
3. Turn off the compressed air main supply

Powder hose rinsing

If longer downtimes take place, the powder hose has to be cleaned.

Procedure:

1. Disconnect the powder hose from the hose connection on the injector
2. Point the gun into the booth
3. Blow through the hose manually with a compressed air gun
4. Connect the powder hose again to the hose connection on the injector

Cleaning

Cleaning the powder container

1. Separate fluidized air cable
2. Remove the injector
3. Remove rinsing module
4. Remove cover, purge with compressed air and clean with a clean, dry brush and cloth
5. Clean the injector and suction intake pipe (Please review injector manual for more on this)
6. Clean rinsing module
7. Empty remaining powder into a container
8. Vacuum up container and in particular the bottom
9. Clean container with a cloth
10. Reconstruct the powder container



Note:

**Do not refill the powder container until just before the next use!
Never clean the powder container with solvents or water!**

Cleaning the OptiFlex 2 GM03 manual powder gun

Frequent cleaning of the gun helps to guarantee the coating quality.



Note:

Before cleaning the powder gun, switch off the control unit. The compressed air used for cleaning must be free of oil and water!

Daily:

1. Blow off the outside of the gun and wipe, clean etc.

Weekly:

2. Remove the powder hose from the connection
3. Remove the spray nozzle from the gun and clean it
4. Blow out the gun from the connection in flow direction with compressed air
5. Clean the integrated gun tube with the provided gun brush
6. Blow through the gun with compressed air again
7. Clean the powder hose
8. Reassemble the gun and connect it



Note:

Please also review the user manual for the OptiFlex 2 GM03 manual powder gun!

Maintenance and cleaning of the filter unit

The filter unit on the OptiFlex 2 L manual coating equipment measures and cleans the compressed air. This is where the equipment's main compressed air connection is located.

Replacing the filter element

Procedure:

1. Unscrew the filter glass on the filter unit
2. Loosen the cap screw
3. Remove the complete filter element



4. Replace the filter element
5. Clean the filter glass on the inside and install it again

Troubleshooting

General information

Note:

Prior to any troubleshooting measures, always check whether the equipment parameters (P0) as configured in the control unit are correct (See operating instructions for the OptiFlex 2 CG09 manual gun control unit, Chapter "Initial Start-up – Setting Equipment Type")

Fault	Causes	Troubleshooting
Control unit displays remain dark, although the control unit is switched on	Control unit is not connected to the mains	Connect the equipment with the mains cable
	Power pack fuse defective	Replace the fuse
	Power pack defective	Contact local Gema representative
The gun does not spray powder, although the control unit is switched on and the gun trigger is pressed	Compressed air not present	Connect the equipment to the compressed air
	Injector, throttle motor or nozzle on injector, powder hose or powder gun are clogged	Clean the corresponding part
	Insert sleeve in the injector is clogged	Replace
	Insert sleeve is not installed	Mount insert sleeve
	Fluidization not running	see below
	Total air incorrectly configured	Set total air correctly (Default value 4 Nm ³ /h)
	Main valve defective	Replace main valve
Gun LED remains dark, although the gun is triggered	Gun not connected	Connect the gun
	Gun plug, gun cable or gun cable connection defective	Contact local Gema representative
	Remote control on powder gun defective	Contact local Gema representative

Fault	Causes	Troubleshooting
Powder does not adhere to object, although the gun is triggered and sprays powder	The objects are improperly or insufficiently grounded	Check grounding, reground at better quality
	High voltage and current deactivated	Press the selection key (application key)
	High voltage cascade defective	Contact local Gema representative
The powder is not fluidized	Compressed air not present	Connect the equipment to the compressed air
	Fluidizing air is set too low on the control unit	Set the fluidizing air correctly
	Throttle motor defective	Contact local Gema representative
No electrode rinsing air	Rinsing air throttle motor defective	Contact local Gema representative

Spare parts list

Ordering spare parts

When ordering spare parts for powder coating equipment, please indicate the following specifications:

- Type and serial number of your powder coating equipment
- Order number, quantity and description of each spare part

Example:

- **Type** OptiFlex 2 L
Serial number 1234 5678
- Order no. 203 386, 1 piece, Clamp - Ø 18/15 mm

When ordering cable or hose material, the required length must also be given. The spare part numbers of this bulk stock is always marked with an *.

Wearing parts are always marked with a #.

All dimensions of plastic hoses are specified with the external and internal diameter:

Example:

Ø 8/6 mm, 8 mm outside diameter (o/d) / 6 mm inside diameter (i/d)



WARNING!

Only original ITW Gema spare parts should be used, because the explosion protection will also be preserved that way. The use of spare parts from other manufacturers will invalidate the ITW Gema guarantee conditions!

OptiFlex 2 L manual coating equipment - Spare Parts

1	CG09 gun control unit - complete (see corresponding operating manual)	1007 018
2	GM03 manual powder gun - complete (see corresponding user manual)	1008 070
3	IG06 injector - complete (see corresponding user manual)	1007 780
4	Pneumatic connection for conveying air - complete (incl. Pos. 4.1, 4.2, 4.3)	1002 888
4.1	Quick release connection - NW5, Ø 8 mm, red	261 645
4.2	Nut with kink protection – M12x1 mm, Ø 8 mm	201 316
4.3	Plastic tube - Ø 8/6 mm, red	103 500*
5	Pneumatic connection for supplementary air - complete (incl. Pos. 5.1, 5.2 and 5.3)	1008 217
5.1	Quick release connection - NW5, Ø 8 mm, black	261 637
5.2	Nut with kink protection – M12x1 mm, Ø 8 mm	201 316
5.3	Plastic tube - Ø 8/6 mm, black	1008 038*
6	Rinsing module – complete (See operating instructions OptiFlex 2 GM03 manual powder gun)	1007 362
7	Pneumatic connection for PowerClean air - complete (incl. Pos. 7.1 and 7.2)	1008 036
7.1	Quick release connection - NW5, Ø 8 mm	1008 027
7.2	Plastic tube - Ø 8/6 mm, black	103 152*
8	Powder container – complete (without Pos. 3 and 6)	379 441
9	Pneumatic connection for fluidization air - complete (incl. Pos. 9.1, 9.2 and 9.3)	382 230
9.1	Quick release connection - NW5, Ø 8 mm	203 181
9.2	Nut with kink protection – M12x1 mm, Ø 8 mm	201 316
9.3	Plastic tube - Ø 8/6 mm, black	103 756*
10	Pneumatic group - complete (see corresponding spare parts list)	
11	Quick release connection - NW7.8 - Ø 13 mm	243 647
12	Venting hose - Ø 16/11 mm, 3 m	105 139*
13	Grounding cable - complete	301 140
14	Powder hose – Ø 15/10 mm, 6m	1001 673*#
15	Short instructions	1007 143
16	Operating manual	1008 219

* Please indicate length

Wearing part

OptiFlex 2 L - Pneumatic group

	Pneumatic group - complete	1007 120
1	Filter cartridge - 20 µm	1007 325

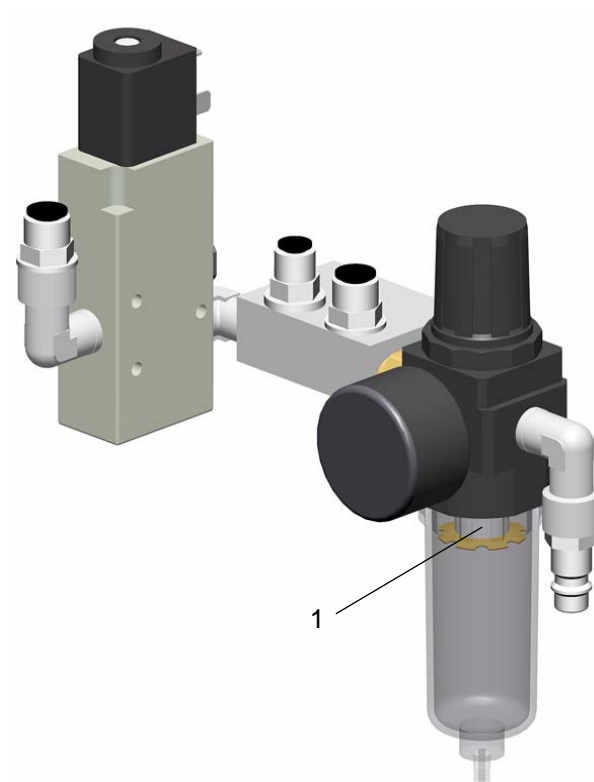

OptiFlex 2 L - Pneumatic group

