Operating instructions and spare parts list

OptiCenter OC02

Powder management center



Translation of the original operating instructions

Documentation - OptiCenter OC02

© Copyright 2008 Gema Switzerland GmbH

All rights reserved.

This publication is protected by copyright. Unauthorized copying is prohibited by law. No part of this publication may be reproduced, photocopied, translated, stored on a retrieval system or transmitted in any form or by any means for any purpose, neither as a whole nor partially, without the express written consent of Gema Switzerland GmbH.

MagicCompact, MagicCylinder, MagicPlus, MagicControl, OptiFlex, OptiControl, OptiGun, OptiSelect, OptiStar and SuperCorona are registered trademarks of Gema Switzerland GmbH.

OptiFlow, OptiCenter, OptiMove, OptiSpeeder, OptiFeed, OptiSpray, OptiSieve, OptiAir, OptiPlus, OptiMaster, MultiTronic, EquiFlow, Precise Charge Control (PCC), Smart Inline Technology (SIT) and Digital Valve Control (DVC) are trademarks of Gema Switzerland GmbH.

All other product names are trademarks or registered trademarks of their respective holders.

Reference is made in this manual to different trademarks or registered trademarks. Such references do not mean that the manufacturers concerned approve of or are bound in any form by this manual. We have endeavored to retain the preferred spelling of the trademarks, and registered trademarks of the copyright holders.

To the best of our knowledge and belief, the information contained in this publication was correct and valid on the date of issue. Gema Switzerland GmbH makes no representations or warranties with respect to the contents or use of this publication, and reserves the right to revise this publication and make changes to its content without prior notice.

Printed in Switzerland

Gema Switzerland GmbH
Mövenstrasse 17
9015 St.Gallen
Switzerland

Phone: +41-71-313 83 00

Fax.: +41-71-313 83 83

E-mail: info@gema.eu.com

Homepage: www.gemapowdercoating.com

Table of contents

General safety regulations	5
Safety symbols (pictograms).....	5
Proper use.....	5
Product specific security regulations	6
General information	6
Installation	7
Earthing.....	7
Operating the equipment	7
Inspection check	7
Repairs.....	8
About this manual	9
General information	9
Software version	9
Product description	11
Field of application	11
Utilization.....	11
Reasonably foreseeable misuse.....	12
Technical data	12
Powder transport.....	12
Electrical data	12
Pneumatic data	12
Dimensions	13
Processible powders	13
Sound pressure level	13
Rating plate.....	13
Structure and function	15
General view	15
Compressed air indicators	16
Operating elements.....	16
OptiSpeeder	17
Powder bag cone	17
Touch Panel	17
Powder hopper (option)	18
Vibration trolley (optional)	18
US06 Ultrasonic sieve system - options	19
Principle of function.....	20
Powder circuit.....	20
Commissioning	21
Set-up and assembly	21
Preparation for start-up	21
Compressed air supply	21
Grounding of the powder management center	22

Operation by touch panel	23
Touch panel/operating panel	23
Touch keypads	24
The screen layout	24
Key functions	24
Function keys	24
State of the keys	26
Operating modes	27
General information	27
Coating without powder recovery (spray waste)	27
Coating with powder recovery	28
Manual coating (option)	28
Cleaning / color change (clean)	28
Setting	29
Parameterization	29
Coating operation	31
Before switching on	31
Starting up the OptiCenter OC02	31
Commissioning	31
Coating with powder recovery (spray)	33
Coating without powder recovery (spray waste)	35
Replacing the powder bag	37
Switching on/off the ultrasonic sieve	39
Screen selection	39
Manual coating	40
Switching off the OptiCenter OC02 (after each work day)	41
Cleaning / color change	43
Cleaning operating mode	43
Cleaning procedure	43
Settings / Parameterization	55
Changing operating language	55
Parameters description	57
Messages	59
Error messages	59
Maintenance	61
Daily after longer working interruptions and at the end of shift	61
Check weekly	61
Decommissioning, storage	63
Introduction	63
Safety rules	63
Requirements on personnel carrying out the work	63
Storage conditions	63
Storage duration	63
Space requirements	63
Physical requirements	63
Hazard notes	64
Shut-down	64
Decommissioning	64
Cleaning	64

Disassembly/attachment of transport safety devices	64
Packing	64
Identification	64
Maintenance during storage	64
Maintenance schedule	64
Maintenance works	64
Return to service	64
Commissioning following storage	64
Packing, transport	65
Introduction	65
Safety rules	65
Requirements on personnel carrying out the work	65
Packing material.....	66
Transport.....	66
Data concerning goods to be transported.....	66
Mode of transportation	66
Loading, transferring the load, unloading	66
Spare parts list	67
Ordering spare parts	67
OptiCenter	68
OptiCenter - Powder supply	69
Fluidizing/suction unit.....	70
OptiSpeeder - complete	71
OptiSpeeder	72
OptiSpeeder - Cover	73
OptiSpeeder - Fluidizing plate.....	74
OptiSpeeder - Level sensor	75
OptiCenter - Pneumatics.....	76
Main air supply	77
OptiSpeeder - Pneumatic manifold	78
Pneumatic manifold Cleaning	79
Pinch valve NW15.....	80
OptiCenter - Roof.....	81
Shuttle valves pool.....	82
Pressure regulators pool.....	83
Monocyclone - Powder transport	84
Monocyclone - Powder transport connection.....	85
Powder hopper.....	86
LC01 Level sensor	87
US06 Ultrasonic sieve.....	88

General safety regulations

This chapter sets out the fundamental safety regulations that must be followed by the user and third parties using the OptiCenter OC02.

These safety regulations must be read and understood before the OptiCenter OC02 is put into operation.

Safety symbols (pictograms)

The following warnings with their meanings can be found in the Gema Switzerland operating instructions. The general safety precautions must also be followed as well as the regulations in the operating instructions.

**DANGER!**

Danger due to electrically live or moving parts. Possible consequences: Death or serious injury

**WARNING!**

Improper use of the equipment could damage the machine or cause it to malfunction. Possible consequences: minor injuries or damage to equipment

**INFORMATION!**



Useful tips and other information

Proper use

1. The OptiCenter OC02 is built to the latest specification and conforms to the recognized technical safety regulations and is designed for the normal application of powder coating.
2. Any other use is considered as non-conform. The manufacturer is not responsible for any incorrect use, the risk for this is assumed by the user alone. If the OptiCenter OC02 is to be used for other purposes or other substances outside of our guidelines then Gema Switzerland GmbH should be consulted.
3. Observance of the operating, service and maintenance instructions specified by the manufacturer is also part of conformity of use. The OptiCenter OC02 should only be used, maintained and started up by trained personnel, who are

informed about and are familiar with the possible hazards involved.

4. Start-up (i.e. the execution of a particular operation) is forbidden until it has been established that the OptiCenter OC02 has been set up and wired according to the guidelines for machinery (2006/42 EG). EN 60204-1 (machine safety) must also be observed.
5. Unauthorized modifications to the OptiCenter OC02 exempt the manufacturer from any liability from resulting damage.
6. The relevant accident prevention regulations, as well as other generally recognized safety regulations, occupational health and structural regulations are to be observed.
7. Furthermore, the country-specific safety regulations also must be observed.

Explosion protection	Protection type
 	IP54

Product specific security regulations

General information

The OptiCenter OC02 is part of the plant and therefore integrated in the safety concept of the plant.

For the use outside of the safety concept, corresponding measures must be taken.



NOTE!
For further information, see the more detailed Gema safety regulations!



NOTE!
If the power supply is interrupted or if there is a power failure, powder can escape unhindered from the container (OptiSpeeder) and contaminate the area around the work opening.
- This area must be cleaned before every start-up

Installation

Installation work to be done by the customer must be carried out according to local safety regulations.

Earthing

Check the grounding of the booth and the powder management center before every start-up. The grounding connection is customer specific and is fitted on the booth basement, on the cyclone and on the powder management center. The grounding of the workpieces and other plant units must also be checked.

Operating the equipment

In order to be able to operate the equipment safely, it is necessary to be familiar with the safety regulations, the operational characteristics and functioning of the various plant units.

For this purpose, read the safety notes, this operating manual and the operating instructions of the plant control unit, before starting up the plant.

In addition, all further equipment-specific operating instructions, e.g. the OptiFlex or OptiMatic and all additional components should also be read.

To obtain practice in operating the plant, it is absolutely essential to start the operation according to the operating instructions. Also, later on, they serve as a useful aid on possible malfunctions or uncertainty and will make many enquiries unnecessary. For this reason, the operating manual must always be available at the equipment.

Should difficulties arise, however, your Gema service center is always ready to assist.

Inspection check

The following points are to be checked at every booth start-up:

- No foreign material in the central suction unit in the booth and in the powder suction
- Sieve machine is connected to the cyclone separator, the clamp is tightly locked
- Pneumatic conduction and powder hose are connected to the dense phase conveyor

Repairs

Repairs must be carried out by trained personnel only. Unauthorized conversions and modifications can lead to injuries and damage to the equipment. The Gema Switzerland GmbH guarantee would no longer be valid.



NOTE!

We point out that the customer himself is responsible for the safe operation of the equipment! Gema Switzerland GmbH is in no way responsible for any resulting damage.

By carrying out repairs, the powder management center must be disconnected from the mains, according to the local safety regulations!



NOTE!

Only original Gema spare parts should be used! The use of spare parts from other manufacturers will invalidate the Gema guarantee conditions!

About this manual

General information

This operating manual contains all important information which you require for the working with the OptiCenter OC02OptiCenter-OC02-de-Vorlage.doc. It will safely guide you through the start-up process and give you references and tips for the optimal use of your new powder coating system.

Information about the function mode of the individual system components - booth, axis, gun control unit, powder gun or powder injector - should be referenced to their enclosed corresponding documents.

Software version

This document describes the operation of the Touch Panels to control the OptiCenter OC02 powder management center with software version 3_3a.



DANGER:

Working without operating instructions

Working without operating instructions or with individual pages from the operating instructions may result in damage to property and personal injury if relevant safety information is not observed.

- ▶ Before working with the device, organize the required documents and read the section "Safety regulations".
 - ▶ Work should only be carried out in accordance with the instructions of the relevant documents.
 - ▶ Always work with the complete original document.
-

Product description

Field of application

The OptiCenter OC02 Powder management center is conceived for simple and clean handling of the coating powder. It enables an automated cleaning procedure and consequently a quick color change. The conception contains all gun and axis control units, as well as the complete fresh powder metering.

As a part of the process controlled coating plant, the powder management center is laid out for fully automatic operation.



Utilization

The OptiCenter OC02 powder management center is suitable for use in plants with a completely closed powder circuit:

Conveying

- Processing the powder directly from the (original) powder bags
- Integrated electrical and pneumatic control units
- Powder level monitoring by level sensor

Cleaning

- Automatic internal cleaning of the suction tubes, injectors, powder hoses and guns
- Refeed of the recovered powder
- Closed powder circuit - no powder escaping during coating or cleaning procedure. This prevents powder loss, and the workplace and the environment remain clean.

Controlling

- No own exhaust system - the powder management center has no own exhaust system and will be therefore connected directly to the After Filter

Reasonably foreseeable misuse

- Use of moist powder
- Insufficient fluidization at the suction point
- Operation without the proper training

Technical data

Powder transport

OptiCenter OC02	
Conveying performance	230 g/Min.
Recovery	max. 3.5 kg/min.

Electrical data

OptiCenter OC02	
Input power	1x230 V
Frequency	50/60 Hz
Protection type	IP54

Pneumatic data

OptiCenter OC02	
Input pressure	min. 6.5 bar
Compressed air consumption during coating operation	15 Nm ³ /h
Compressed air consumption during cleaning (incl. OptiSpeeder and guns)	350 Nm ³ /h
Compressed air consumption during cleaning of the PP06 hose to the cyclone	120 Nm ³ /h
Water vapor content of compressed air	max. 1.3 g/m ³
Oil content of compressed air	max. 0.1 mg/m ³

Dimensions

OptiCenter OC02		with AS04	with AS04+ICS03
Base area (width x depth) (mm)	1150 x 1500	1700 x 1500	1700 x 1500
Overall height (mm)	2100 (2270 - PP06 connection)		
Weight (kg)	ca. 400		

Processible powders

OptiCenter OC02	
Plastic powder	yes
Metallic powder	yes
Enamel powder (continuous duty)	OptiFeed PP06-E only

Sound pressure level

OptiCenter OC02	
Normal operation	75 dB(A)
Cleaning operation mode	for a short time up to 95 dB(A)

The sound pressure level was measured while the unit was in operation; measurements were taken at the most frequent operator positions and at a height of 1.7 m from the ground.

The specified value is applicable only for the powder management center itself and does not take into account external noise sources or cleaning impulses.

The sound pressure level may vary, depending on the powder management center configuration and space constraints.

Rating plate



NOTE!

Fields with a gray background contain contract-specific data!

Structure and function

General view

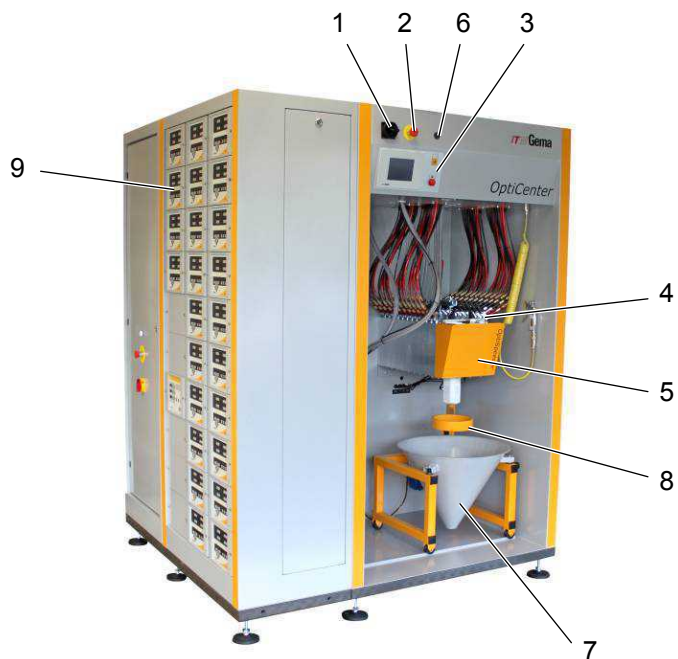

OptiCenter OC02 - layout

- | | | | |
|---|------------------------------|----|----------------------------------|
| 1 | Main switch | 7 | Powder bag cone with vibrator |
| 2 | Emergency stop push button | 8 | Powder bag fixation |
| 3 | Control unit/operating panel | 9 | Gun and axes control units |
| 4 | Injectors | 10 | "Waste" connection |
| 5 | OptiSpeeder | 11 | OptiSpeeder connection |
| 6 | Vibrator switch | 12 | Powder hopper venting connection |

Compressed air indicators

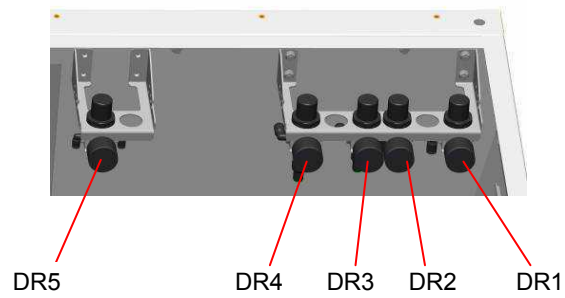

- DR1 AirMover
- DR2 OptiSpeeder fluidizing air
- DR3 Level sensor fluidizing air
- DR4 Valve block supply
- DR5 Fluidizing/suction lance fluidizing air

Operating elements

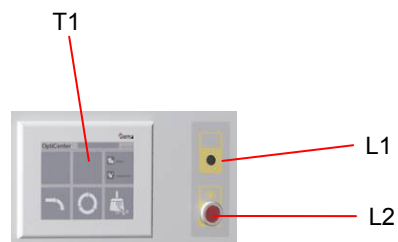

Designation	Function
T1	Touch Panel
L1	Hopper full indicator (green)
L2	Powder shortage indicator (red)

OptiSpeeder

The OptiSpeeder is suited for the automated preparation and fluidization of the coating powder.

The OptiSpeeder can contain 6 / 7 kg powder, and can be equipped with up to 24 or 30 IG06-P OptiFlow injectors.



Powder bag cone

- Capacity up to 25 kg
- Mobile to allow the powder to be emptied easily
- Fluidizing/suction lance
- Fresh powder pump connection
- Recovery powder pump connection

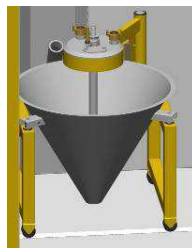

Touch Panel

All necessary operating procedures are activated by the Touch Panel.



Powder hopper (option)



- for more than 24 guns
- Capacity 60 or 100 litres
- fluidized, with venting connector
- suitable for metallic powders
- level sensor optionally available

When using the powder hopper, the venting hose must be connected to the connector , and the ball valve (12) must be open during the entire operation.



NOTE!

Is there no powder hopper, the ball valve must be closed.

Vibration trolley (optional)

The vibration trolley can be built into the OptiCenter instead of the powder cone. The power connection for the vibrator and the grounding are identical for both devices. Thus, the vibration trolley can be installed quickly.



NOTE!

To ensure problem-free powder transport to the OptiSpeeder, the number of guns (16) must not be exceeded.

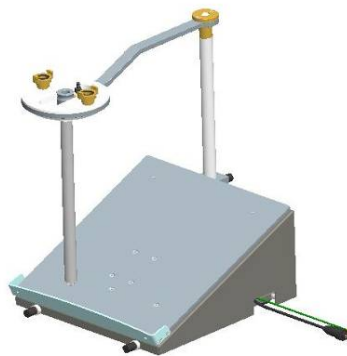

The powder is supplied directly from the OptiCenter powder box. When the OptiSpeeder is emptied, the vibration trolley can be brought into position under the OptiSpeeder. This allows rapid emptying into the powder box.



Working position

- Changing the powder box
- The suction lance is located in the powder box



Cleaning position

- Direct emptying into the powder box

US06 Ultrasonic sieve system - options

The US06 Ultrasonic sieve system with the corresponding Ultrasonic sieve generator is used for the ultrasonic supported sieving of coating powder. It is exclusively used inside the OptiSpeeder powder container.

Four mesh widths are available: 140 µm, 200 µm, 250 µm and 300 µm.

The sieve configuration and sieve selection are done on the TouchPanel.



NOTE!

For additional information, please see the operating instructions of the ultrasonic sieve system!

Principle of function

Powder circuit

During the typical OptiCenter OC02 (7) operation, the powder bag is put in the powder bag cone. The powder is fluidized in the bag with the fluidizing/suction lance and then fed to the OptiSpeeder in the OptiCenter OC02. The fluidized powder is aspirated by the injectors and fed through the powder hoses to the guns/spray nozzles (8). The powder, which does not adhere to the workpieces, will be absorbed by the exhaust air of the booth (1) and separated from the air in the cyclone separator (2).

The separated powder is cleaned by passing it through the integrated sieve (3) and fed back into the OptiSpeeder by the dense phase conveyor (4), where it is prepared again for coating operation.

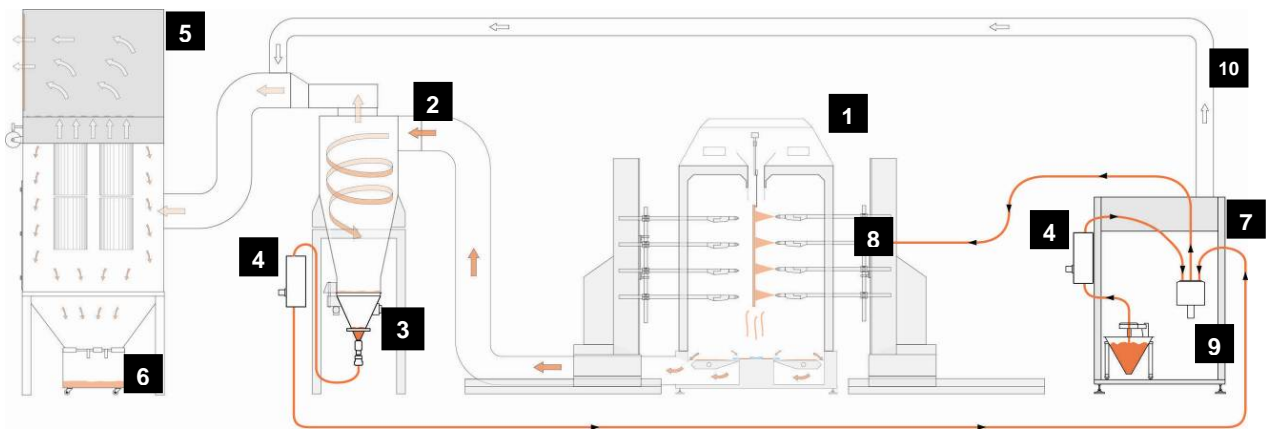

Powder flow in the plant

- | | |
|-----------------------------|------------------------|
| 1 Booth | 6 Refuse container |
| 2 Cyclone separator | 7 OptiCenter |
| 3 Sieve | 8 Automatic guns |
| 4 OptiFeed PP06 Powder pump | 9 OptiSpeeder |
| 5 After Filter | 10 Exhaust air ducting |

Commissioning

Set-up and assembly



NOTE!

Installation work to be done by the customer must be carried out according to local safety regulations!



WARNING:

The OptiCenter must only be installed in locations with an ambient temperature of between +20 and +40 °C, i.e. never next to heat sources (such as an enameling furnace) or electromagnetic sources (such as a control cabinet).

Preparation for start-up

Compressed air supply



NOTE!

The compressed air must be free of oil and water!

The OptiCenter requires a connection to a sufficient dimensioned compressed air circuit.

In order to ensure a perfect operation, a pressure of **6 bar** must be adjusted with the main pressure regulator.



Compressed air supply

Grounding of the powder management center

**DANGER:**

The OptiCenter must be grounded according to the general, local safety regulations. The grounding of the powder management center must be checked regularly.

A corresponding connection point at the OptiCenter is reserved for the potential equalization.

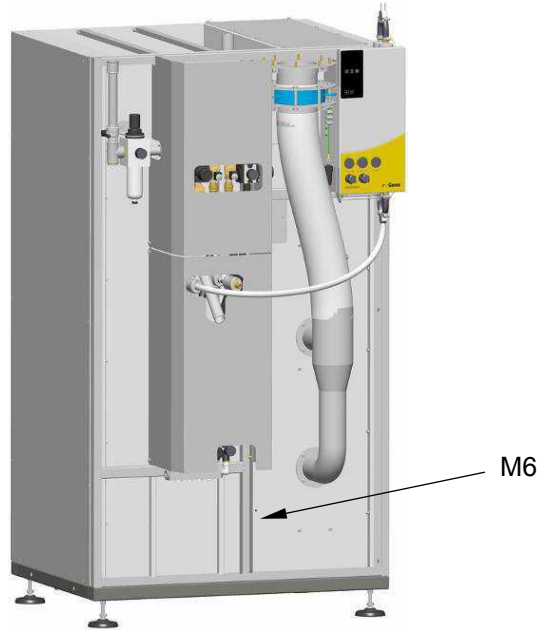

Potential equalization - connection point

Operation by touch panel

Touch panel/operating panel

The operation and monitoring of the OptiCenter system takes place by the touch-sensitive operating panel of the control unit.

The operating panel serves to initiate the function commands, which are necessary for the satisfactory operation of the powder management center. The function parameters are also entered by the control panel. These are set at the factory and, therefore, may only be changed after consultation with a Gema service center.



Operating panel

Touch keypads

The key functions are activated by touching the screen within this area. An illumination means that the touch keypad was directly touched.

The screen layout

The **exit** key enables switching back to the previous program level. The other operating keys switch to the next corresponding program menu.

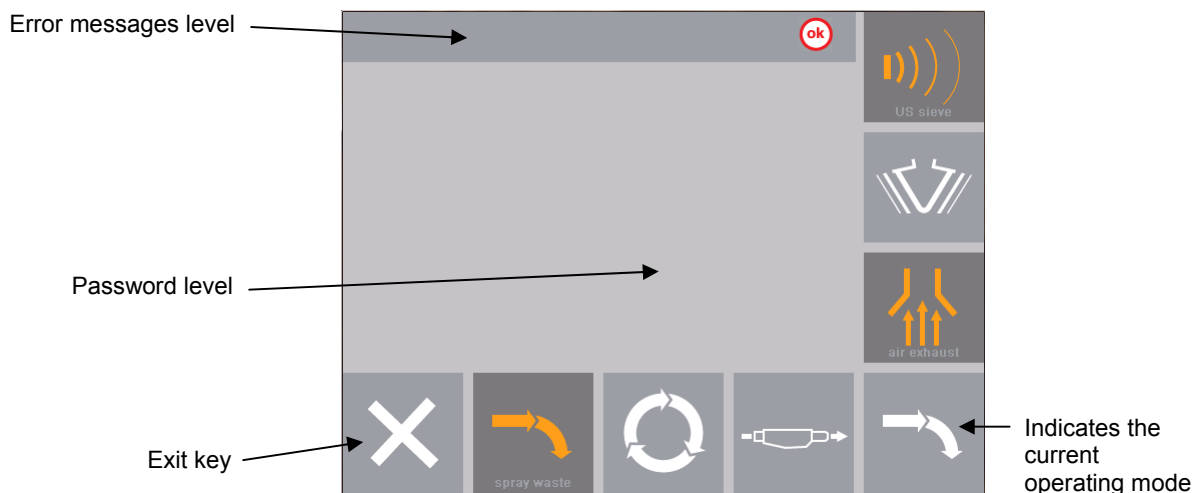

NOTE!

The designation (labeling) of pictograms is made in English only and is used by Gema worldwide for identification of technical support issues.

The symbols are designed for the user, who will be guided through the plant by means of pictures. All operation and error messages are not displayed as pictograms, and are adapted to the local language according to the Sales contract!

Key functions



WARNING:

The keys of the input field should only be pressed with fingertips and under no circumstances with fingernails or hard objects!

Function keys



- Start the powder management center for coating
- Key is not activated, until boot is ready
- For this function, no log-in is necessary



- Cleaning for color change
- Key is not activated, until boot is ready
- For this function, no log-in is necessary



- Error acknowledgement, alarm horn switches off.

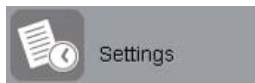

- Adjustments
- For this function, a log-in is necessary



- Parameters
- For this function, a log-in is necessary



WARNING:

The function parameters are set at the factory and may not be changed by the customer!

Parameters may only be modified after consultation with a Gema service center!

State of the keys

Some of the keys light up orange when pressed.

Some of the keys will start flashing if the corresponding process requires confirmation.

These flashing keys are shown in this user manual as follows:



Operating modes

General information

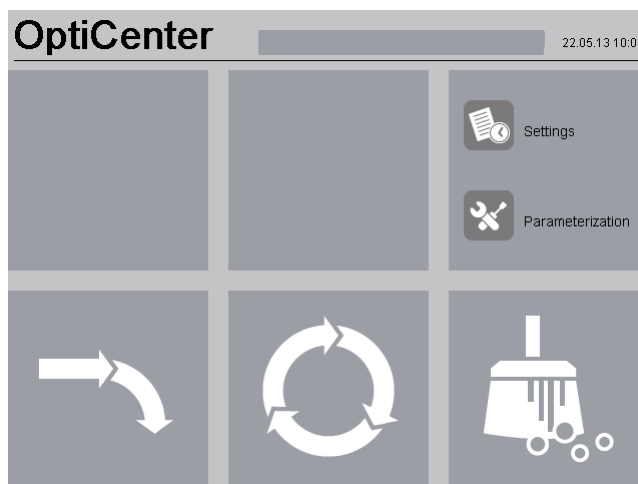

The following operating modes are available:



- **different coating modes**
- **Cleaning / color change**
- **Service/parameterization**

The operating modes are explicitly described in the following chapters.

The operation level of the control unit is designed with pictograms, so that only the really essential parameters are displayed, and the operator can therefore reach his solution quickly.

Basically, the control unit is not in one of these operating modes after switching on, or after a restart. The operating modes are selected on the panel.

Coating without powder recovery (spray waste)



There is no powder recovery in this coating mode - the powder, which does not adhere to the object, is fed directly to the waste.

Utilization of this operating mode:

- **When restarting the plant or after the color change (a few minutes)**
- **If highest coating quality claim is required**
- **If the volume of order is very small**

Coating with powder recovery



This coating mode allows the coating with recovery of the powder, which does not adhere to the object.

Utilization of this operating mode:

- Long time coating operation with the same powder and high coating quality with minimal powder loss
- Immediate coating following a powder change with minimum demands on quality and the smallest possible of powder loss

Manual coating (option)



There is no powder recovery in this coating mode - the powder, which does not adhere to the object, is fed directly to the waste.

NOTE!

This coating mode is deactivated by default but can be activated as needed.

- ▶ Parameter no. set 40 to 1 (for more on this, see Chapter "Parameterization")
-

Utilization of this operating mode:

- When restarting the plant or after the color change (a few minutes)
- If highest coating quality claim is required
- If the volume of order is very small

Cleaning / color change (clean)



This operating mode enables the user to choose, on the first cleaning screen, between **Fast cleaning** and **Quality cleaning**. In the procedure of both of these cleaning modes, there is no difference, only the preset parameters are different (cleaning times). The higher the requirement for cleanliness, the higher is the time expenditure.

Each of these cleaning modes consists of two parts, the coarse cleaning and the fine cleaning. The coarse cleaning mode does recover the powder, the fine cleaning mode does not (powder loss).

The cleaning of the components is partially automated, however, some of them must be cleaned manually.

The **Cleaning** operating mode can be selected from every coating operating mode, or from the **Standby** operating mode.

Utilization of this operating mode:

- After switching on the equipment, if very high quality is required on initial coating application
- Before every color change

Setting



This mode allows the user to make specific OptiCenter settings or to read information:

- User administration
- Operator and system language
- Brightness, date/time, communication, diagnostics, network
- Information regarding operating hours, hardware and software

Parameterization



This operating mode enables the user to modify the parameters.

Coating operation

Before switching on

Before switching on the OptiCenter, the following points must be observed:

- Observe the safety regulations
- Check the grounding of the OptiCenter, the booth and the other plant units and ensure it, if necessary
- Check the compressed air supply

Starting up the OptiCenter OC02

Commissioning



WARNING:

The keys of the input field should only be pressed with fingertips and under no circumstances with fingernails or hard objects!

The start-up takes place according the following steps:

1. Switch on the booth (see also the booth operating instructions) - the **Booth ready** signal may be present
2. Switch the powder management center with the main switch:
 - the interior lighting switches on
3. Wait for booth release
 - the display shows the basic menu



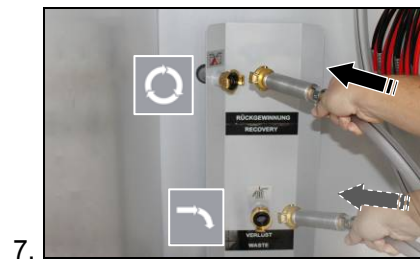

8. Select the coating type required on the OptiCenter (**coating with** or **without powder recovery**)
9. Select desired operating mode (**AUTOMATIC** or **MANUAL**) on the booth control unit (see therefore the corresponding operating manual)



NOTE!

If there is an Emergency stop or if there is a possible power failure, the pinch valve under the OptiSpeeder remains closed, so that no powder can escape from the container unhindered.

Coating with powder recovery (spray)

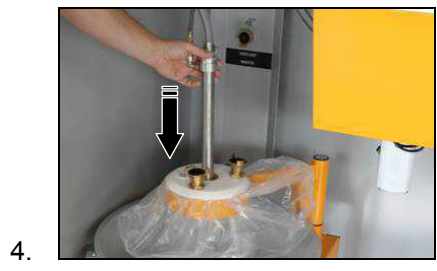
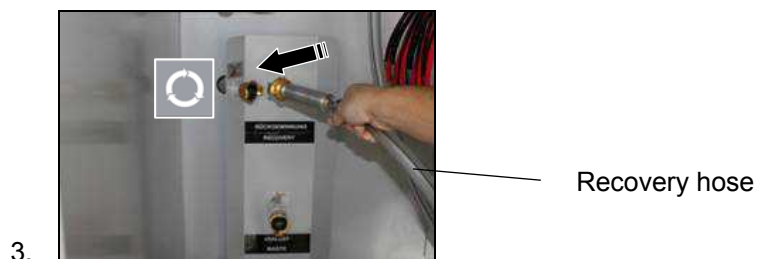
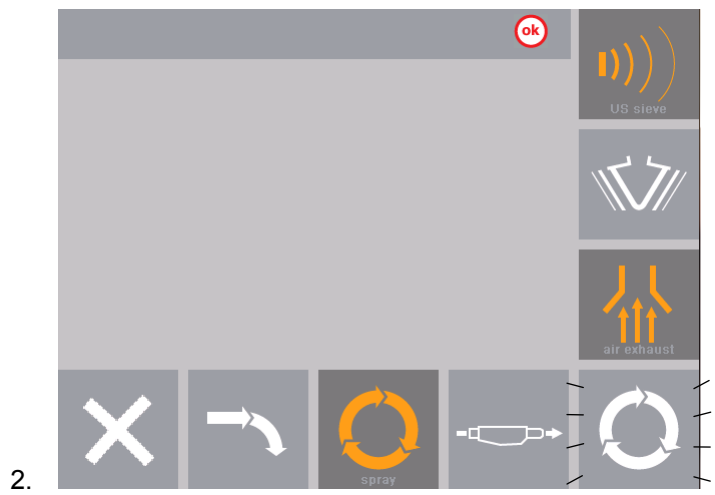
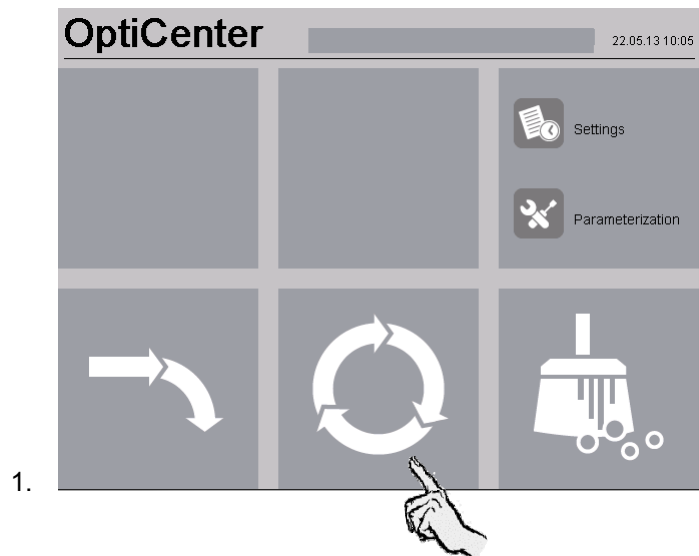

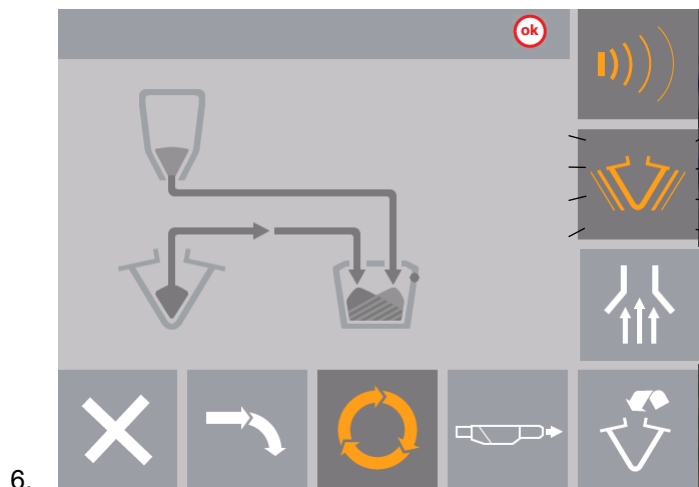



- the fluidization of the suction lance switches on
- The vibrator is switched on

7. Do not start coating until the level sensor indicator  lights up. The OptiSpeeder is now filled with powder.
- the vibrator switches off
 - Coating can now commence

8. If necessary, replace the powder bag, see also "Replacing the powder bag"

9. The extraction system  is switched off by default, but can be manually switched on and off as needed

10. If an error message appears, acknowledge it to ensure that the coating process continues to run

11. The key  closes the **Coating** menu and returns to the main menu

Coating without powder recovery (spray waste)

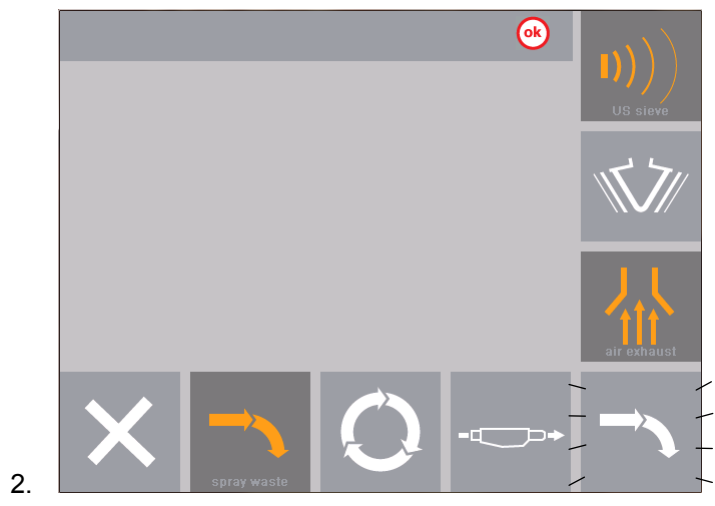
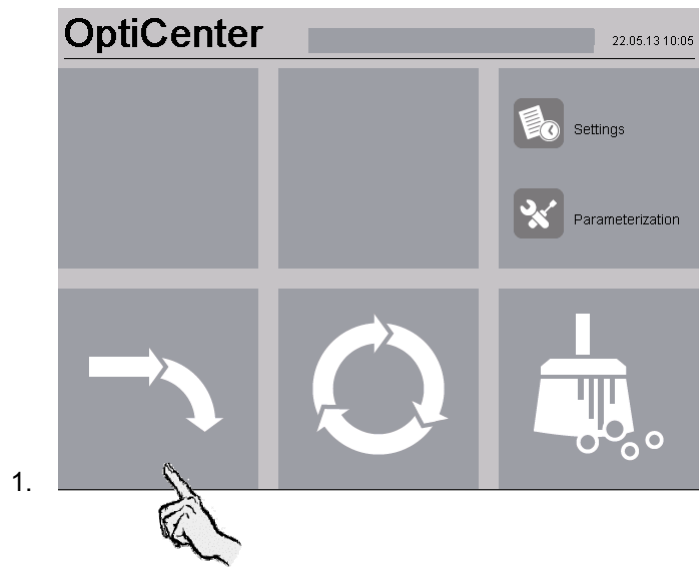

3. The extraction system is automatically switched on  and cannot be manually switched off

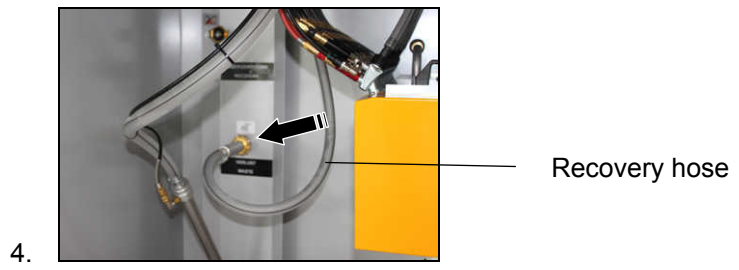

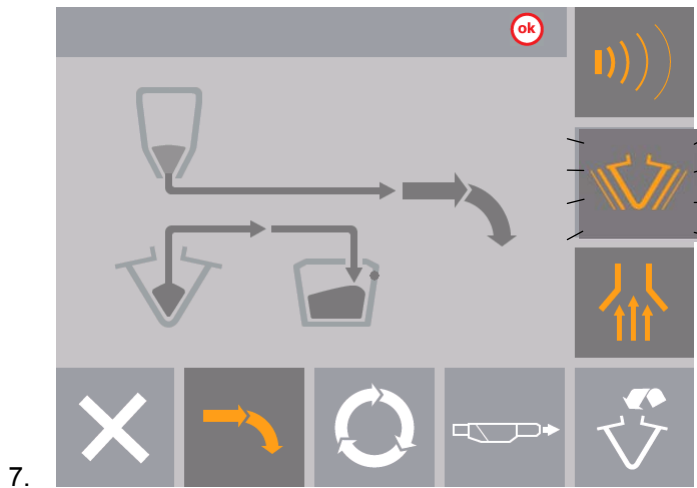
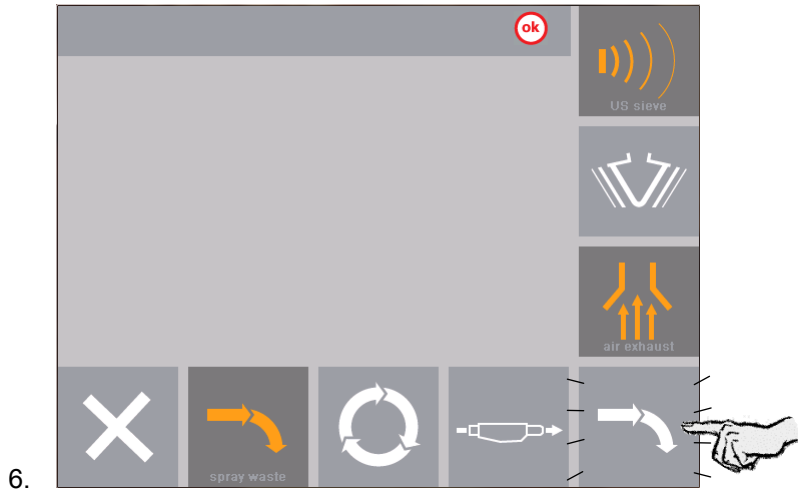
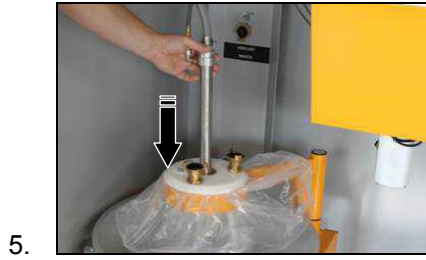

- Suction lance fluidization is switched on
- The vibrator is switched on

8. Do not start coating until the level sensor indicator  lights up. The OptiSpeeder is now filled with powder.
- Coating can now commence

9. If necessary, replace the powder bag, see also "Replacing the powder bag"

10. The key  closes the **Coating** menu and returns to the main menu

Replacing the powder bag

1. Check visually the powder level in the bag cone
2. Hold the full powder bag ready

3.  Switch this on if it has not been switched on already

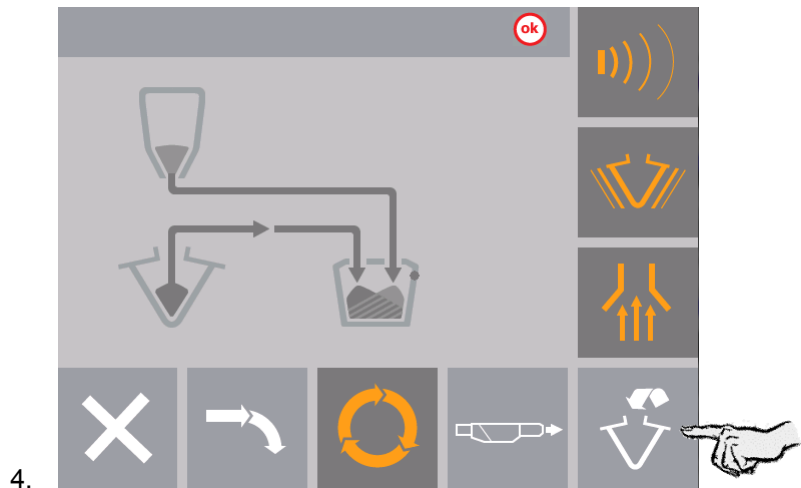

6. The powder pumps and the vibrator are stopped
7. Empty the used powder bag with the residual powder into another container or dispose of it



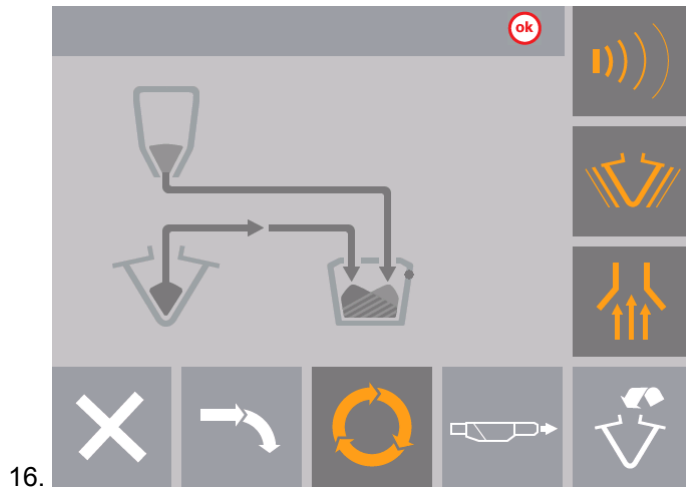
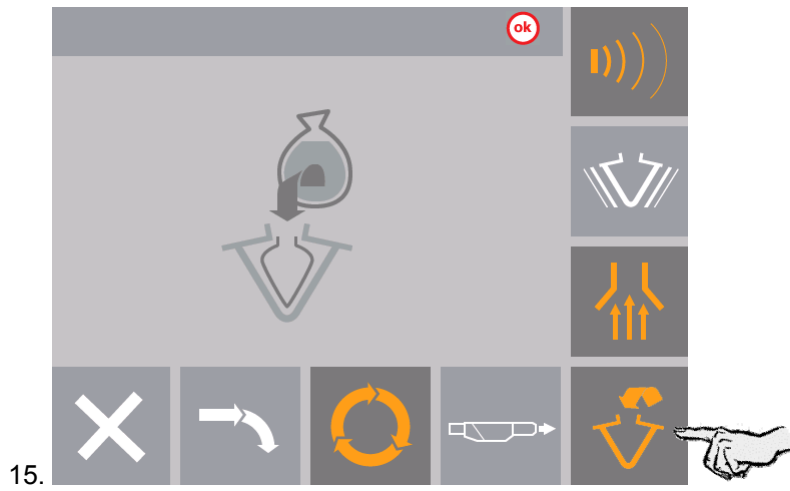
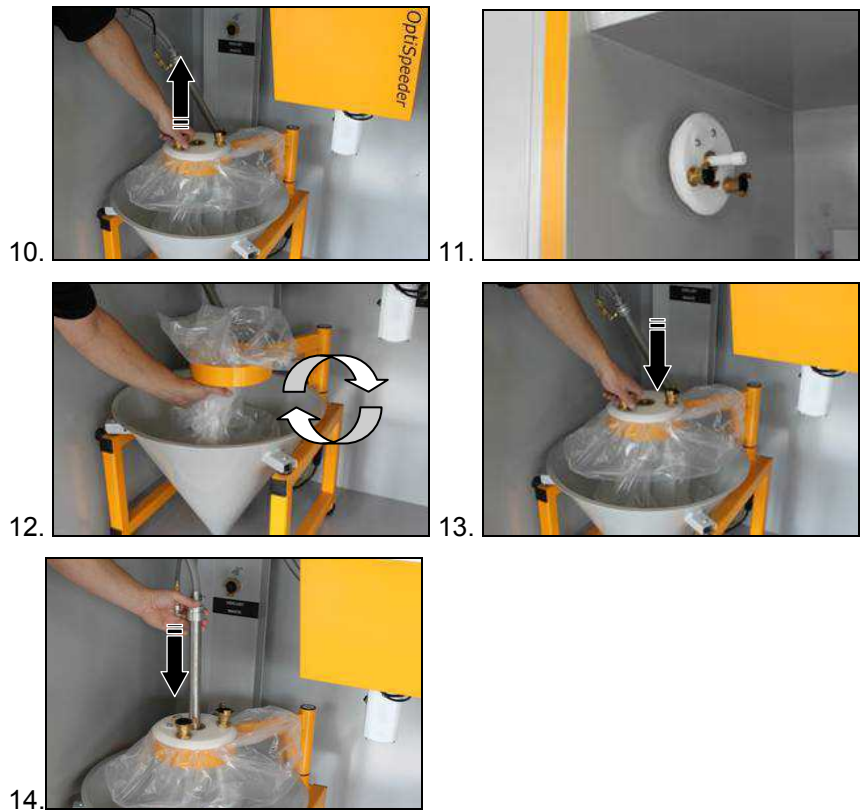

Switching on/off the ultrasonic sieve



The ultrasonic screen is on.

This button can be used to switch off the ultrasonic screen at any time.



The ultrasonic screen is off.

Screen selection

If the customer uses more than one screen, the OptiCenter panel displays a relevant choice of mesh sizes.



NOTE!

Only previously configured mesh sizes are displayed, however. For more on this, see "Sieve configuration"

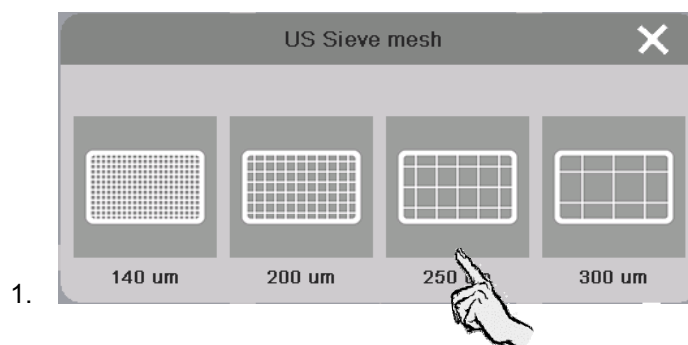

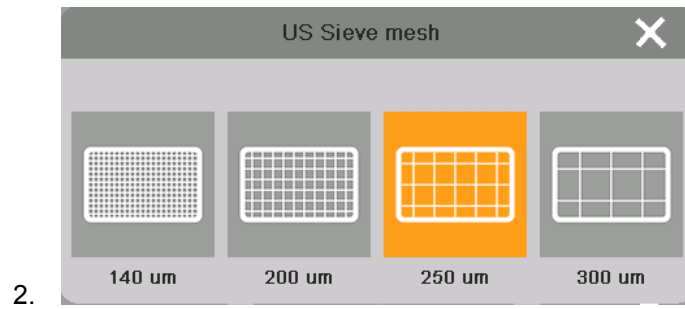

The selected mesh size remains active until the system is switched on again.

Manual coating

NOTE!

This coating mode is deactivated by default but can be activated as needed.

- ▶ Parameter no. set 40 to 1 (for more on this, see Chapter "Parameterization")



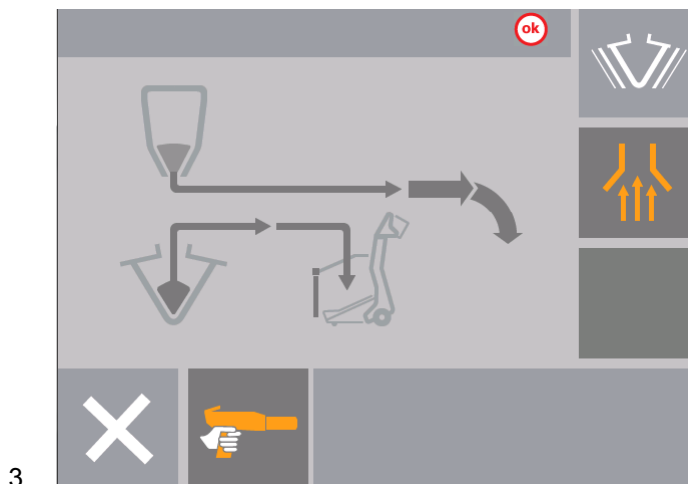

Switching off the OptiCenter OC02 (after each work day)



NOTE!

Before the equipment can be turned off, the contents of the container (OptiSpeeder) should be emptied into the powder bag in the cone. This will prevent the powder from absorbing moisture during the night, which can cause no or uneven fluidization.

The following steps must be taken to switch off the powder center:

1. Check if all the workpieces have been coated



2. Press the  key
The following menu appears on the display:

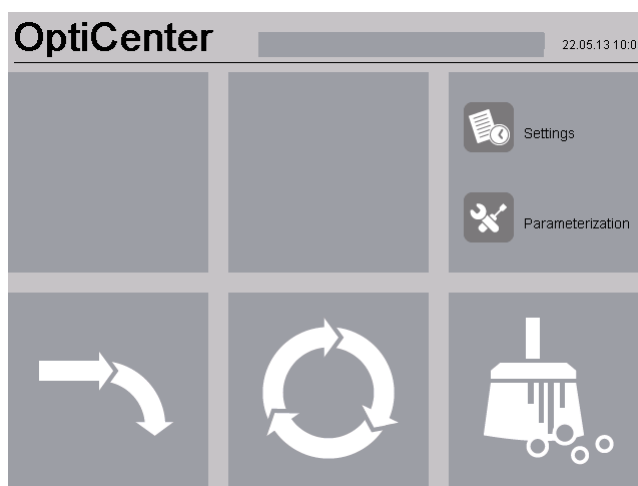

- the level control is switched off
- the vibrator switches off

3. Clean the OptiCenter thoroughly, in order to avoid powder accumulation (see therefore in chapter "Cleaning / Color change")



WARNING:
Empty the OptiSpeeder!

4. Switch off the powder management center at the main switch
 - The interior lighting is no longer lit

Cleaning / color change



WARNING:

Peak noise levels (for a short time up to 95 db(A)) occurring during the cleaning process may cause hearing damage!

- Do not approach the OptiCenter unless absolutely necessary!
 - Wear adequate hearing protectors (e.g. ear muffs per EN 352-1)!
-



NOTE!

A great deal of air is required for the cleaning procedure!

Make sure that 6 bar is always available!



WARNING:

Powder can escape if the OptiSpeeder lid is not closed properly.

- Check that the lid fits properly
 - Check if the clamp has locked in place properly. The clamp's closing tension has been set in the factory and must never be changed!
-

Cleaning operating mode

Cleaning procedure

Plant control (e.g. Magic Control CM30)

1. Select the cleaning mode.
2. Close the booth doors
3. Clean the guns externally
4. Adjust the movement axes to the cleaning position, so that the guns can be cleaned from the inside.

OptiCenter

5. End the coating procedure



6. Press the  key
The following menu appears on the display:

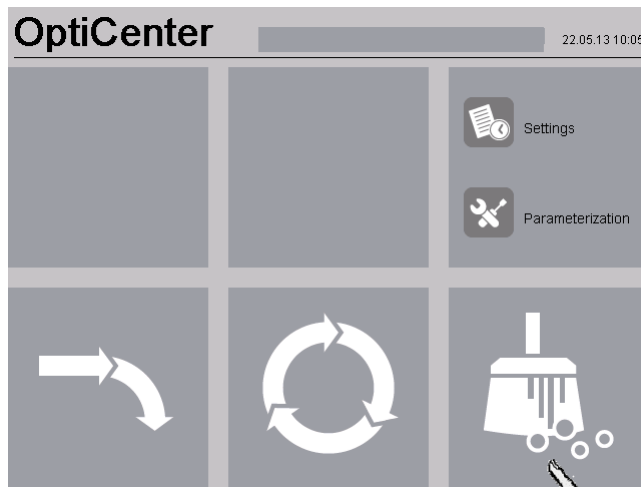

7. 

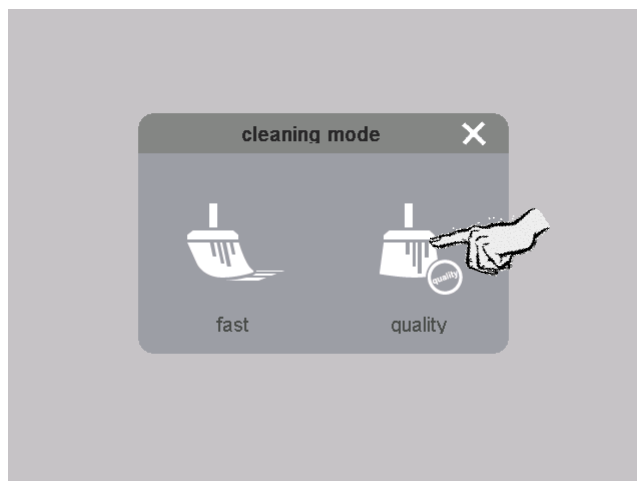

- 8.

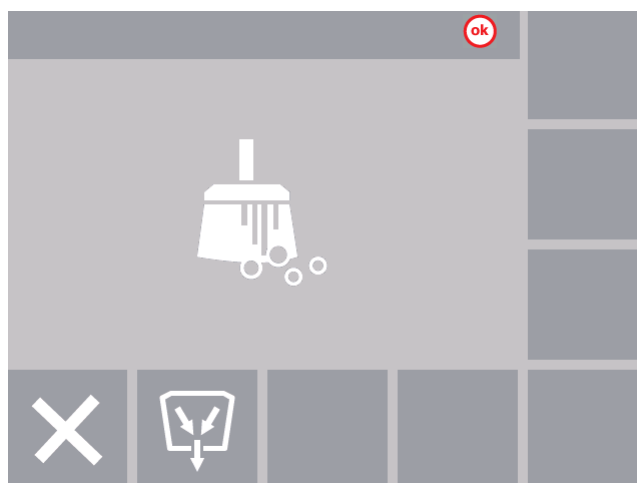

- 9.

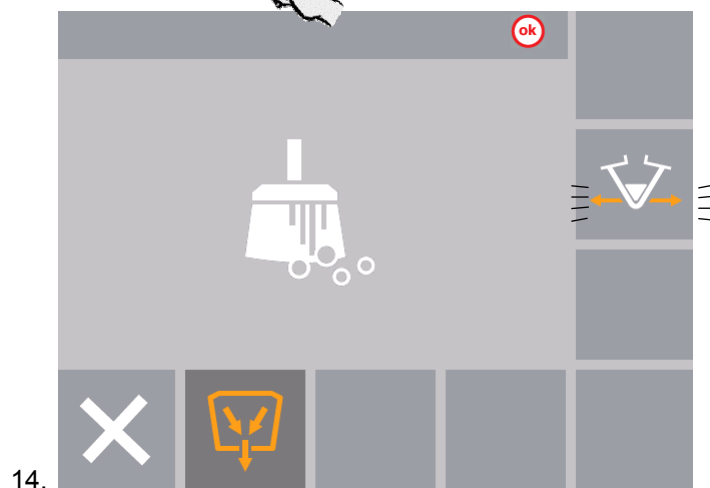



15.

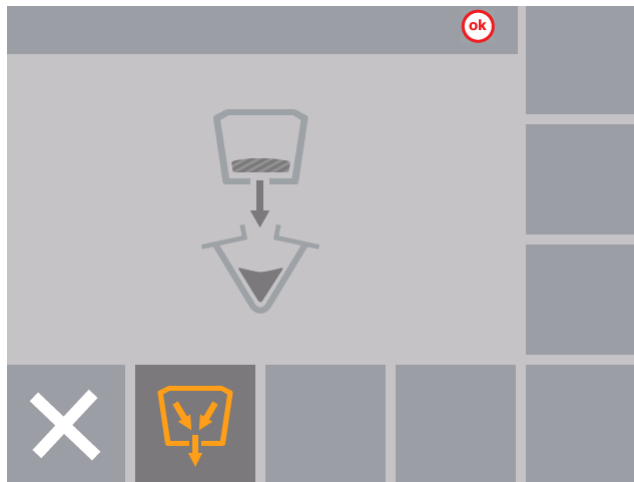

16.

17. As soon as the trolley is in the right position, the pinch valve below the OptiSpeeder opens and the powder in the OptiSpeeder flows into the powder bag



18. If the key  looks like this, the process has completed. The key can be pressed once again if necessary. This is a sign that the next cleaning phase needs to be activated.

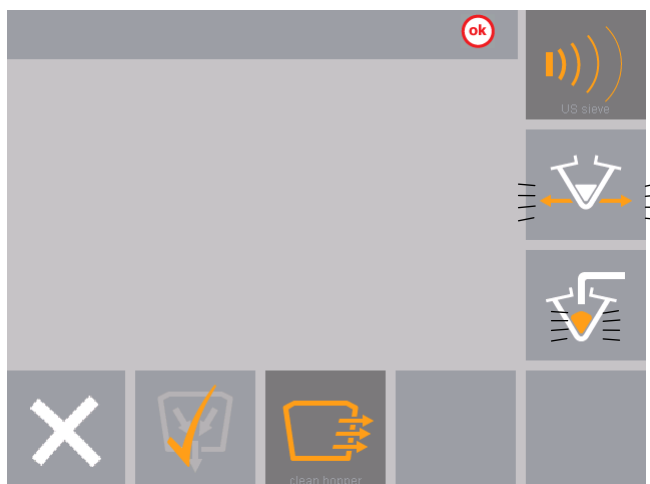

19.



Recovery hose

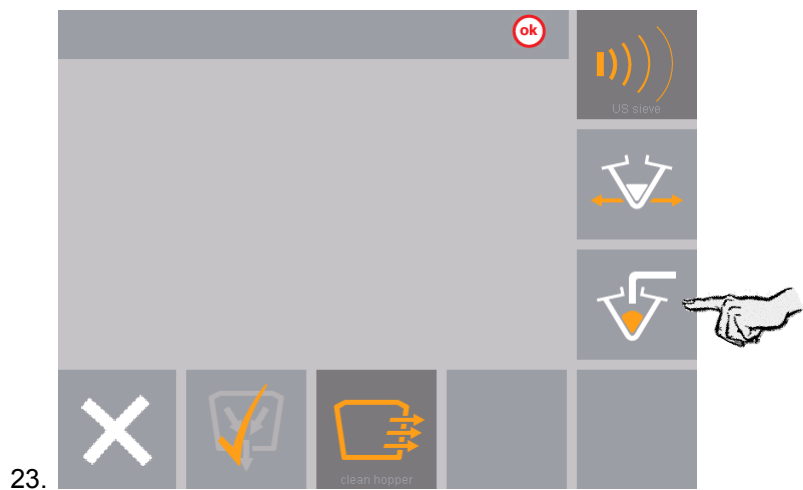

25. The OptiSpeeder is cleaned, the powder from the OptiSpeeder is transported into the extraction system (waste)

26. The powder from the booth will be fed back in the powder bag



27. The process is complete once this symbol is displayed (after approx. 180 seconds for **intensive cleaning** and approx. 30 seconds for **fast cleaning**).



NOTE!

Any individual step can be repeated as needed by pressing the corresponding key again. Otherwise, the next cleaning step can be activated.

28. Basic booth cleaning can be started now already. Activate the corresponding command on the Magic Control CM30/22



NOTE!

If you do not want this powder to be recovered, connect the recovery hose to the waste connection.

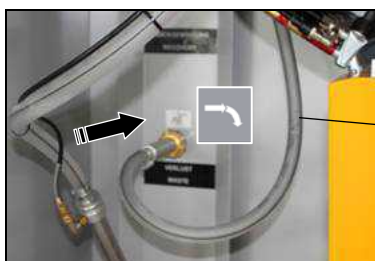

Recovery hose

29.

30. Finish cleaning the booth

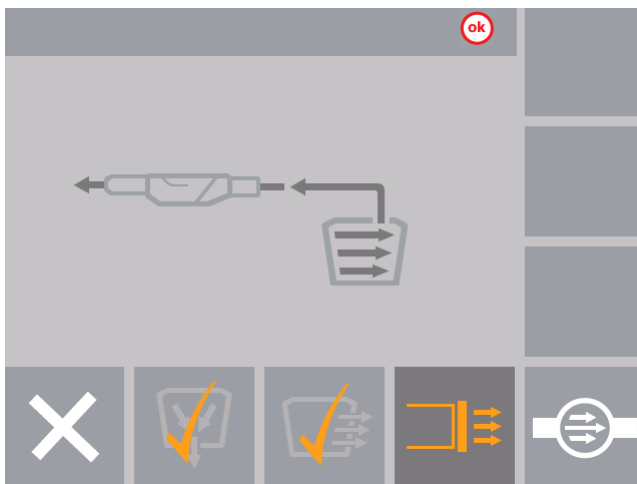

31.

- The powder hoses are cleaned and the powder is transported to the extraction system (waste)
- The powder from the booth is returned to the powder bag



32. The process is complete once this symbol is displayed. Depending on the number of injectors, cleaning will last for:
40 seconds (1-12 injectors),
80 seconds (1-24 injectors) or
120 seconds (1-36 injectors).

The key can be pressed once again if necessary. Otherwise, the next cleaning step can be activated.

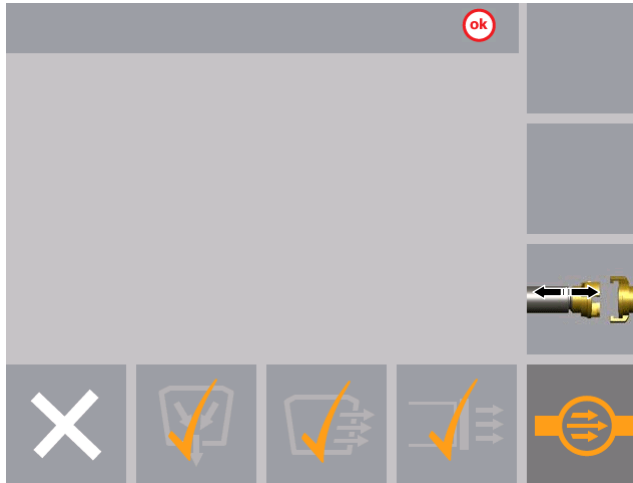

33.

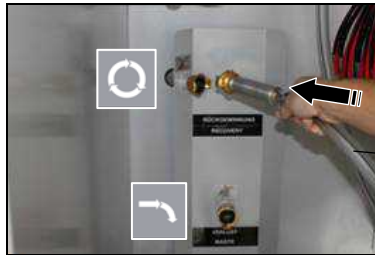

34.

Recovery hose



35.



36.



37. Cleaning the OptiCenter



NOTE!

If an ultrasonic screen has been installed, it is susceptible to damage during cleaning.

- The OptiSpeeder must only be cleaned with the original cover fitted.

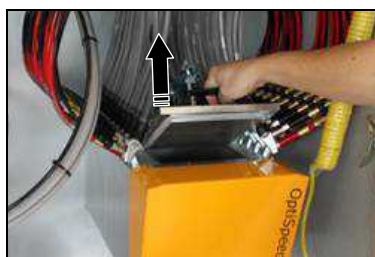

38.



Original cover ?

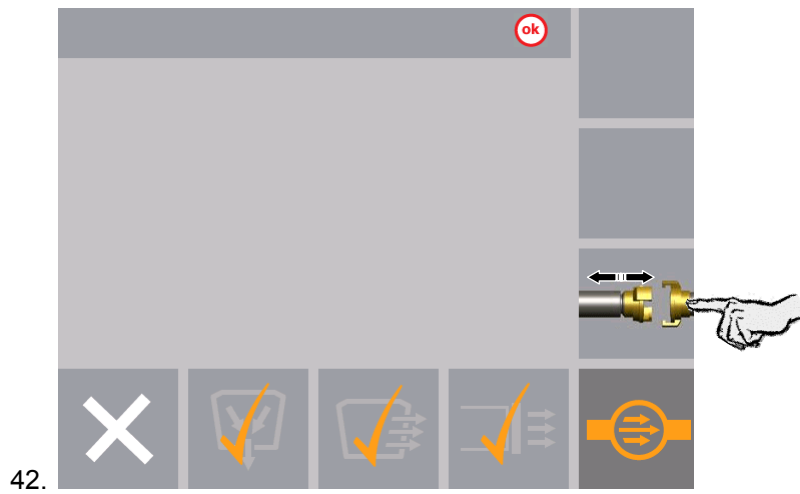
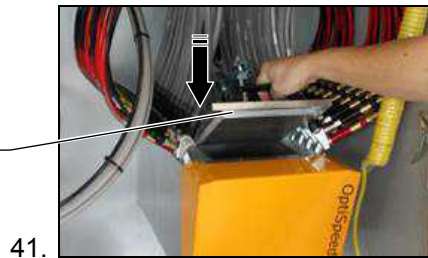



43. - The fresh powder pump is cleaned. The powder is transported to the extraction system (waste).

44. The process is complete once this mask is displayed.

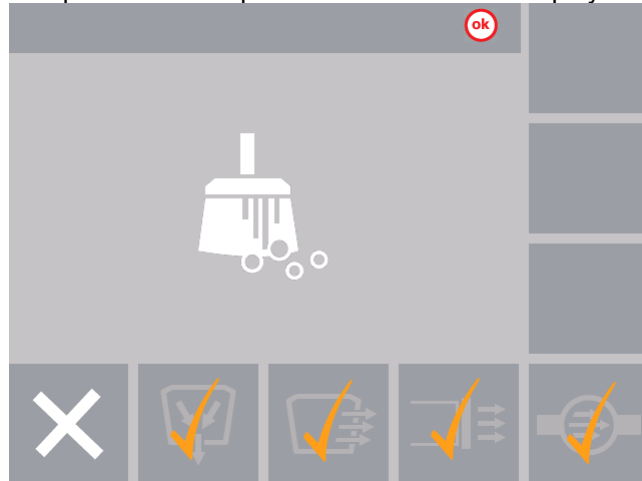

45. Open the monocyclone



WARNING:

In order to avoid damage to the sieve when blowing through the transport hose, make sure that the sieve is swung out completely during the cleaning process!

46. Slowly swing out the sieve and clean it with the compressed air gun





47. Press the button on the monocyclone
The cleaning process is started.
48. The hose is blown through in pulses



NOTE!

The procedure can be stopped or resumed manually by the user.

49. Swing the funnel on the cyclone slowly away and, at the same time, clean it off with the compressed air gun
50. Clean the inside of the cyclone with the cleaning lance
51. Close the sieve and funnel on the cyclone again



52.



53.



54.



55. Press the  key
The start mask appears on the display
- The extraction system will continue running for approximately 1 minute

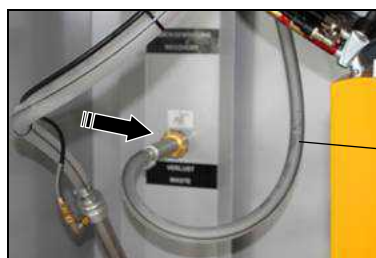

56.

Recovery hose

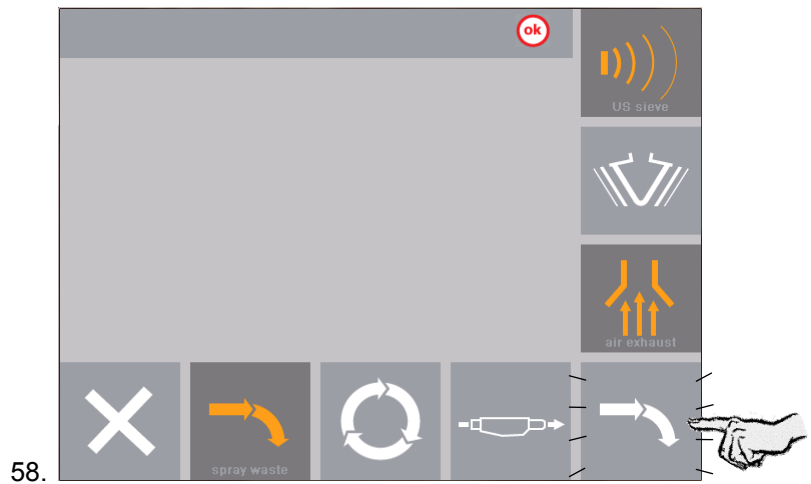
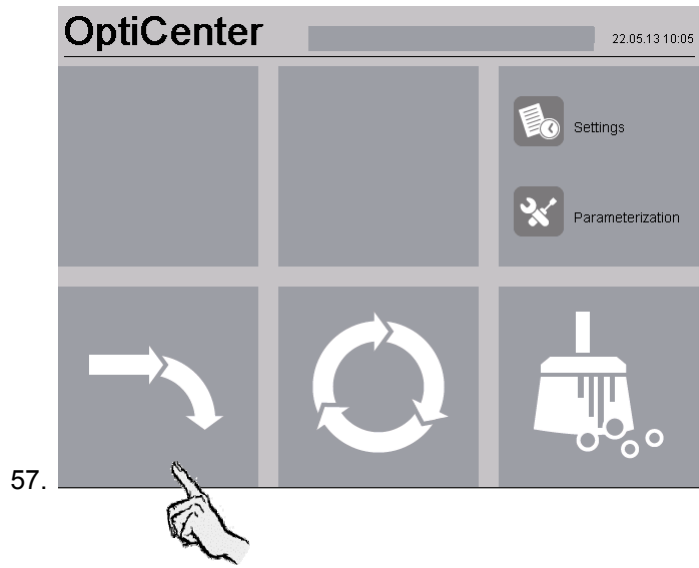

59. Do not start coating until the level sensor indicator lights up. The OptiSpeeder is now filled with powder.
60. Keep the guns switched on until the first hangers have passed.

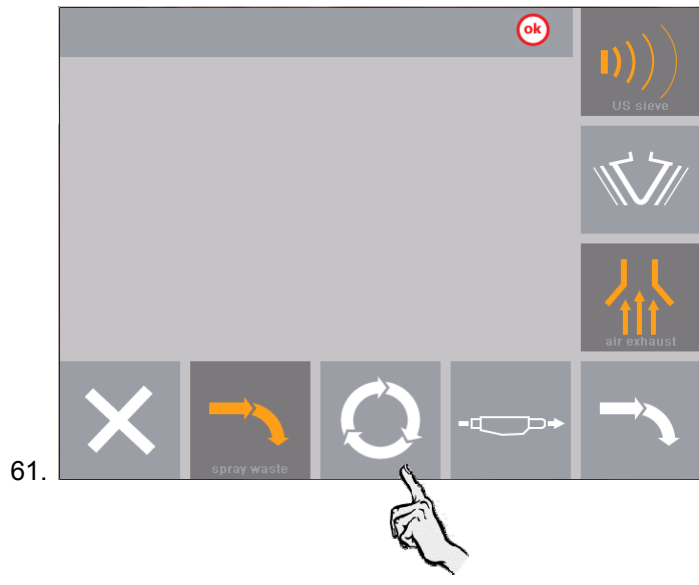

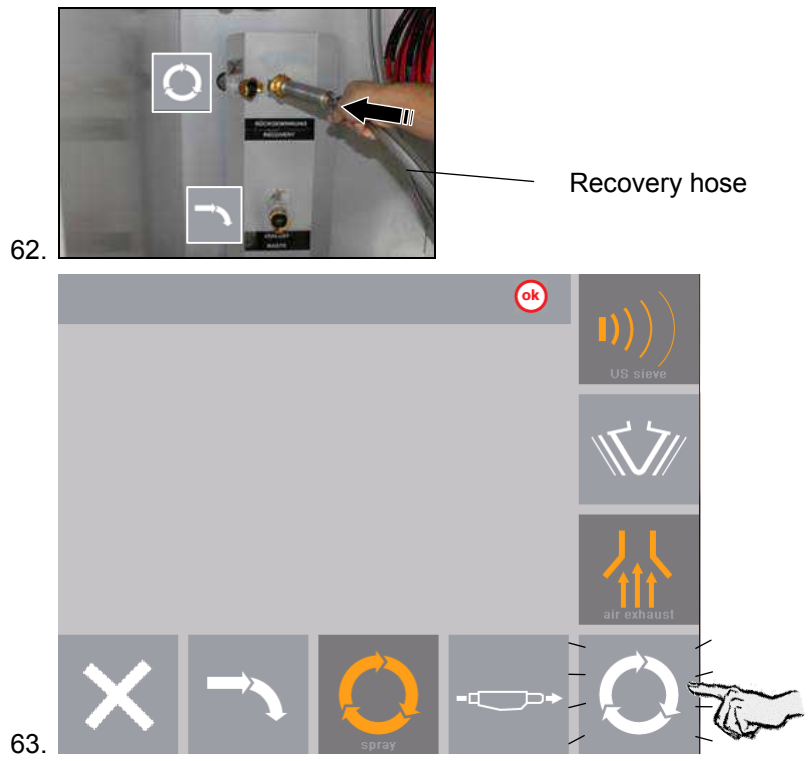

Settings / Parameterization



WARNING:

All OptiCenter settings are set at the factory and may not be changed by the customer!

Parameters may only be modified after consultation with a Gema service center!

Changing operating language

In order to input the settings on the operating panel, the plant must be in operation. To do this, proceed as follows:

1. Switch on the booth (see the booth operating instructions) - the **Booth ready** signal may be present
2. Switch on the control voltage in the powder management center with the key switch:
 - the key switch returns to its starting position
 - the interior lighting switches on
 - the display shows the basic menu

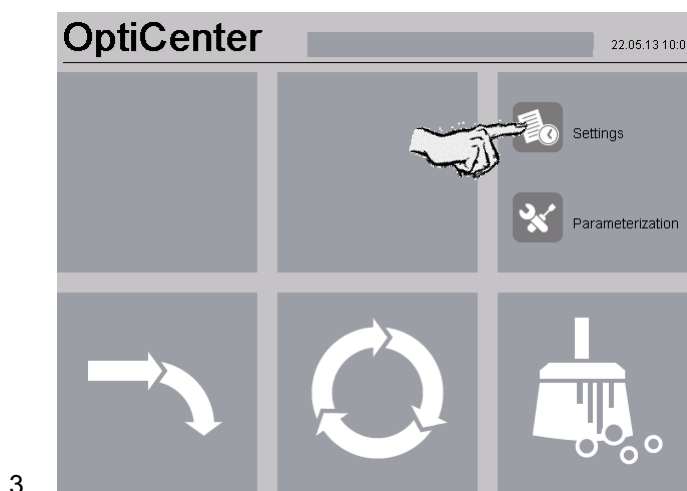



4.



NOTE!

The login screen for parameters also appears if the user presses long enough on the center of the screen.

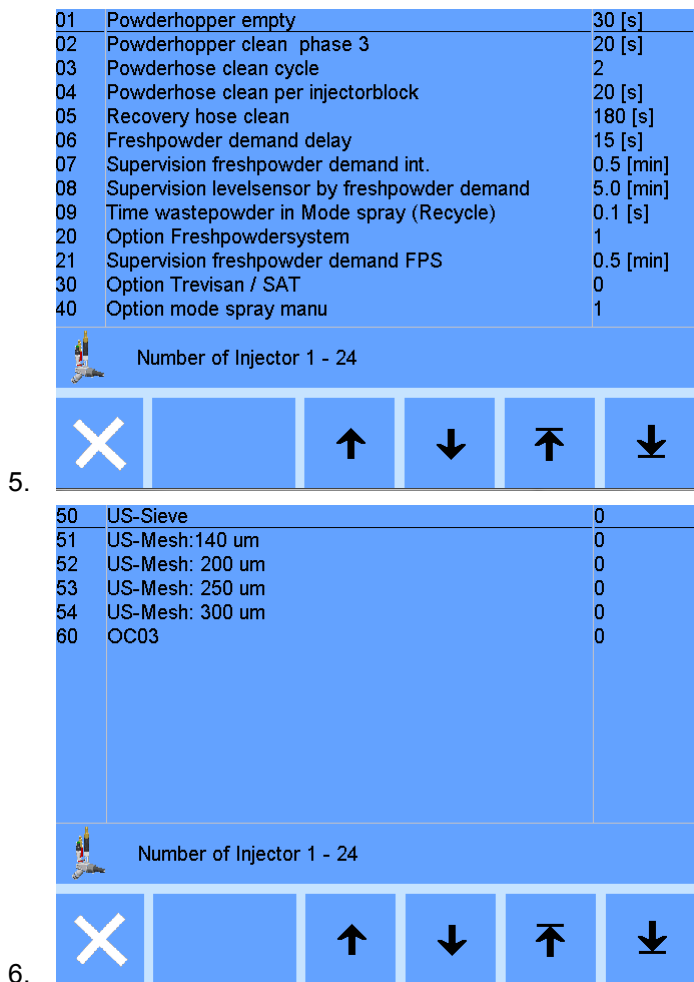

5.

6.

7. Press the  key, the previous menu appears

Parameters description

No.	Parameters	Description	Value
01	Empty powder hopper	Time - how long it takes to empty the powder container	15 – 40 s
02	Powder hopper clean quality	Cleaning the powder container in the quality cleaning mode	10 – 30 s
03	Powder hose clean loops		2 – 5 loops
04	Powder hose cleaning per injector block		20 – 40 s
05	Recovery hose cleaning		60 – 600 s
06	Fresh powder request delay		0 – 180 s
07	Monitoring the fresh powder request		15 – 300 s
08	Monitoring the level sensor during fresh powder request		180 – 600 s
09	Time Waste powder in Spray Mode (Recovery)		1 – 600 s
10	WRS kit	Solenoid valves for the automatic control of waste or recovered powder	0 / 1
20	Option Fresh powder system		0 / 1
21	Monitoring the fresh powder request FPS		15 – 300 s
30	Option "Trevisan / SAT"		0 / 1
40	Option Operating mode "Manual coating"		0 / 1
50	US sieve		0 / 1
51	US sieve: 140 µm		0 / 1
52	US sieve: 200 µm		0 / 1
53	US sieve: 250 µm		0 / 1
54	US sieve: 300 µm		0 / 1
55	US sieve: Sieving the fresh powder	If the fresh powder is also to be sieved	0 / 1
60	OC03		0 / 1

Screen configuration

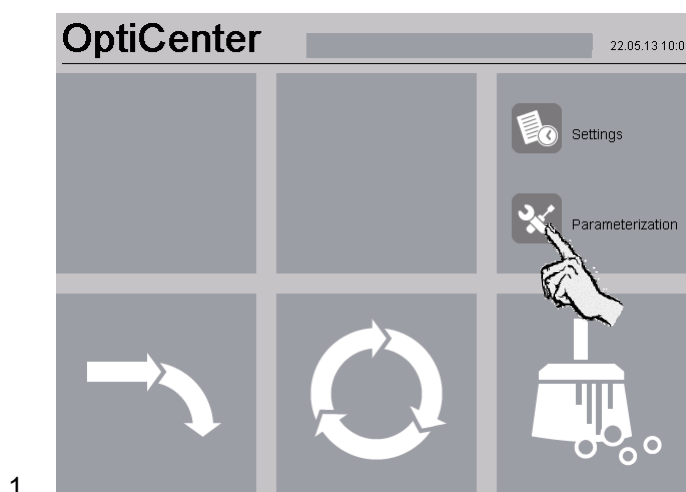

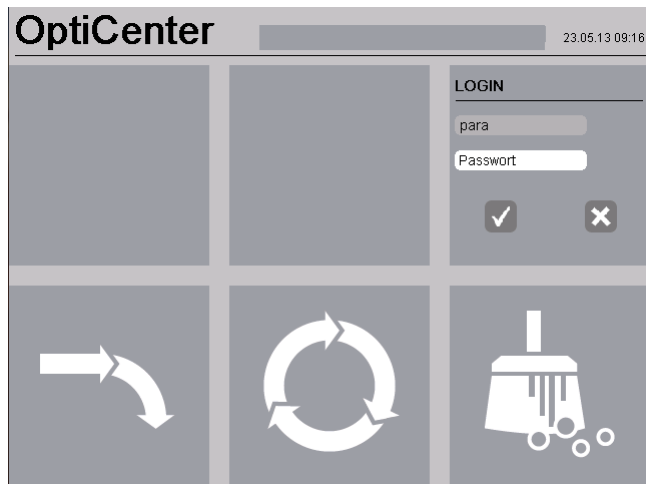

2.





01	Powderhopper empty	30 [s]
02	Powderhopper clean quality	30 [s]
03	Powderhose clean cycle	2
04	Powderhose clean per injectorblock	20 [s]
05	Recovery hose clean	180 [s]
06	Freshpowder demand delay	15 [s]
07	Supervision freshpowder demand int.	0.5 [min]
08	Supervision levelsensor by freshpowder demand	5.0 [min]
09	Time wastepowder in Mode spray (Recycle)	0.1 [s]
10	WRS-Kit	0
20	Option Freshpowdersystem	0
30	Option Trevisan / SAT	0
40	Option mode spray manu	0

Number of Injector 1 - 36

Navigation buttons: Close (X), Up, Down, Page Up, Page Down

3.

4. Select the ultrasonic sieve (parameter no. 50) using the arrow keys

-  = page up
-  = line up
-  = line down
-  = page down

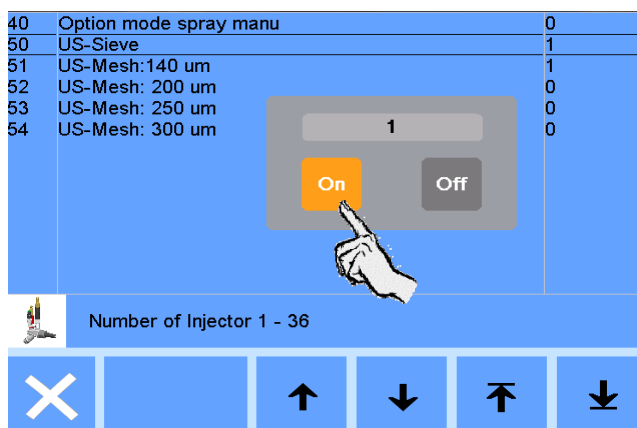

5.

Screen active = 1

6. Activate the used mesh size(s).

7. Press the button  to exit the parametrization dialog. Any changes are saved.

Messages

Error messages

If faults occur in the powder management center, an error message shown in red lettering appears on the display. The causes of these errors must be eliminated, before further procedures can be carried out (see therefore the troubleshooting guide).

If the error has been eliminated, the display returns to the previous menu again.

Display	Description	Action
 is lit	OptiSpeeder empty, level sensor indicates the status, no coating operation possible:	
	Powder accumulation on level sensor	Open OptiSpeeder service cover and front panel: <ul style="list-style-type: none"> - Clean the sensor - Readjust the sensor sensitivity - Check the fluidizing of the sensor if necessary, increase the fluidizing air pressure - Remove the fluidizing air hose and check it
	Sensor defective	replace
	Cable defective	replace
Vibrator defective	Motor protection switch Q6 has reacted	Remove the small maintenance panel and switch on the motor protection switch again. With repeated Alarms, contact a Gema service center
	Vibrator defective	replace
	Cable broken	replace
Powder recovery pump conveying problem	Powder pump does not function properly	
	- Pump defective	- see corresponding operating manual OptiFeed PP06
	- Hose clogged	Check the recovery system
		- Check the level sensor (see also Error message no. 03)
		- Check the cyclone funnel for powder abrasion
	- Contact an Gema service center	

Display	Description	Action
Powder recovery pump overpressure	Powder pump is switched off	
	- Hose clogged or connected incorrectly	Check the recovery system and/or connect correctly
	- Pressure sensor at the OptiFeed PP06 Powder pump defective	replace (see also corresponding OptiFeed PP06 operating manual)
24 V valve block failure	Safety equipment (F7) has reacted, control unit switches to Standby mode	Check the 24 VDC Power pack (G4)
		Check the safety equipment whether all 4 LEDs illuminate green
		- If one or more LEDs illuminate, reset the corresponding channel and if necessary, restart
Fuse Fxx defective	Fuse (1 AT) in the WAGO-Modul A1 defective, control unit switches to Standby mode	Replace the fuse, otherwise contact a Gema service center
Powder alert in OptiSpeeder	Powder warning, flashlight activated	Check the powder bag, otherwise powder shortage
Powder shortage in OptiSpeeder	Powder bag empty, chain conveyor is stopped, flashlight activated	Replacing the powder bag
CAN bus malfunction	No communication with CM30/CM22	Switch on the CM30/CM22 superordinated control unit
	CAN-Bus participant defective	Contact an Gema service center

Maintenance

Daily after longer working interruptions and at the end of shift



WARNING:
Before switching off the plant, the OptiSpeeder must be emptied and cleaned.

Check weekly

- Check the injector nozzles and replace them, if necessary

Decommissioning, storage

Introduction

Safety rules

Suitable equipment (e.g. a crane) must be used when moving parts that are sometimes bulky and heavy.

Components being disassembled must be adequately secured before they are detached.

Requirements on personnel carrying out the work

Use only technical personnel who are trained in operating the respective equipment (e.g. a crane).

If there are any uncertainties, please contact Gema.

Storage conditions

Storage duration

If the physical conditions for metal parts and electronics are maintained, the unit can be stored indefinitely. On the other hand, the installed elastomer components (pinch valve collars, O-ring seals, etc.) can become brittle over time and crack when put under repeated loads.

Space requirements

The space requirements correspond to the size of the OptiCenter.

The load-bearing capacity of the floor should be at least 500 kg/m².

There are no special requirements concerning distance to neighboring equipment.

Physical requirements

Storage must be inside a dry building at a temperature between +5 and +40 °C. Preferably in a cool, dry and dark space.

Do not expose to direct sunlight.

Hazard notes

There is no danger to personnel or the environment if the unit is stored properly.

Shut-down

Decommissioning

Before starting any kind of work, the OptiCenter must be disconnected from the compressed air supply.

- Relieve pneumatic pressure on the system
- Unplug the power cable
- Unplug the ground cable
- Empty the OptiSpeeder (see "Cleaning")

Cleaning

The complete OptiCenter is to be cleaned according to the instructions in the operating manual.

Disassembly/attachment of transport safety devices

- Secure the hopper car and powder bag mount (final position left)

Packing

It is recommended that the OptiCenter be placed on a dimensionally stable, adequately large palette using a forklift truck with long forks. To prevent damage to the components, collisions with other parts must be prevented.

Identification

Apply the label "Protect from dampness and moisture" on the product and the packaging.

Maintenance during storage

Maintenance schedule

No maintenance schedule is necessary.

Maintenance works

During long-term storage, periodically perform a visual check.

Return to service

Commissioning following storage

Following storage of more than 3 years, the rubber components must be checked and replaced if necessary.

Packing, transport

Introduction

This chapter describes special precautions that must be taken during internal transport of the product if:

- the customer himself must pack, transport and ship the product, such as to have renovations or service work carried out by the manufacturer

or

- the product must be shipped for disposal (recycling).

Safety rules

Suitable equipment (e.g. a crane) must be used when moving parts that are sometimes bulky and heavy.

Components being disassembled must be adequately secured before they are detached.

Requirements on personnel carrying out the work

Use only technical personnel who are trained in operating the respective equipment (e.g. a crane).

If there are any uncertainties, please contact Gema.

Packing material

A suitably stable pallet must be used.



Transport

Data concerning goods to be transported

- The space requirements correspond to the size of the components plus the packaging
- Weight see "Technical Data"
- Points of attachment, see "Mode of transportation"

Mode of transportation

For short distances/shifts of position within the same room, parts for the booth must be transported using a forklift truck with long forks.



Transport the unit only in the position according to its intended use.

Loading, transferring the load, unloading

Suitable lifting equipment is to be used for all procedures.

Spare parts list

Ordering spare parts

When ordering spare parts for powder coating equipment, please indicate the following specifications:

- Type and serial number of your powder coating equipment
- Order number, quantity and description of each spare part

Example:

- **Type** OptiCenter OC02
Serial number 1234 5678
- **Order no.** 203 386, 1 piece, Clamp - Ø 18/15 mm

When ordering cable or hose material, the required length must also be given. The spare part numbers of this yard/meter ware is always marked with an *.

The wearing parts are always marked with a #.

All dimensions of plastic hoses are specified with the external and internal diameter:

Example:

Ø 8/6 mm, 8 mm outside diameter (o/d) / 6 mm inside diameter (i/d)



WARNING!

Only original Gema spare parts should be used, because the explosion protection will also be preserved that way. The use of spare parts from other manufacturers will invalidate the Gema guarantee conditions!

OptiCenter

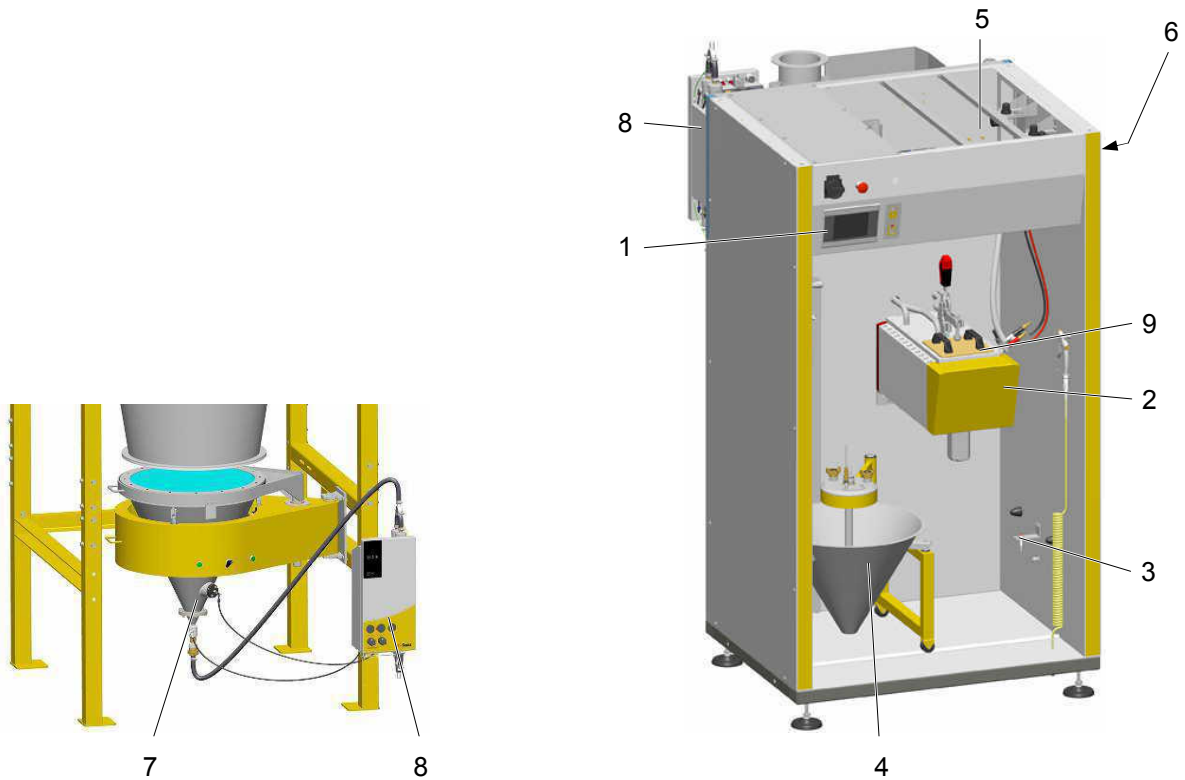

1 Touch Panel - 5,7" (see enclosed wiring diagram)	269 450
Compact Flash card - 32 MB for pos. 1 (not shown)	269 018
2 OptiSpeeder - see corresponding spare parts list	
3 Proximity switch	1007 912
4 Powder supply - see corresponding spare parts list	
5 Roof - see corresponding spare parts list	
6 Pneumatics - see corresponding spare parts list	
7 Powder transport - see corresponding spare parts list	
8 OptiFeed PP06 Powder pump - see corresponding operating manual	
9 US06 Ultrasonic sieve - see corresponding spare parts list	

OptiCenter - Powder supply

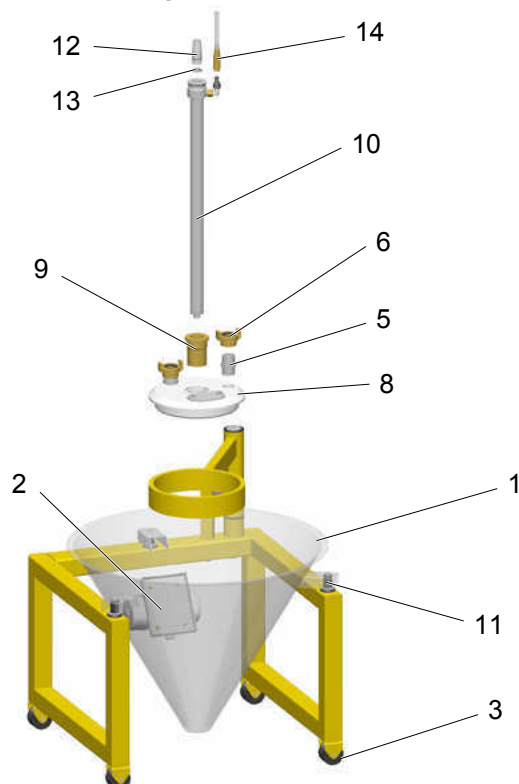

1	Cone	1006 190
2	Vibrator - 220-240 V	1007 082
3	Roller set - 4 rollers + 4 screws	720 001
5	Double nipple - 3/4"a-3/4"a	228 028
6	GEKA coupling - 3/4"-IG	1002 551
8	Cover	1007 177
9	Cover bushing	1005 245
10	Fluidizing/suction unit - Ø 28 mm, complete	1005 332
11	Rubber damper set - Ø 20x25 mm, M6/21 mm (3 pieces)	720 000
12	Hose connection - complete, incl. pos. 13	1007 658
13	O-ring - Ø 16x2 mm	1007 794#
14	Quick release connection - NW5-Ø 6 mm	200 840

Wearing part

* Please indicate length

Fluidizing/suction unit

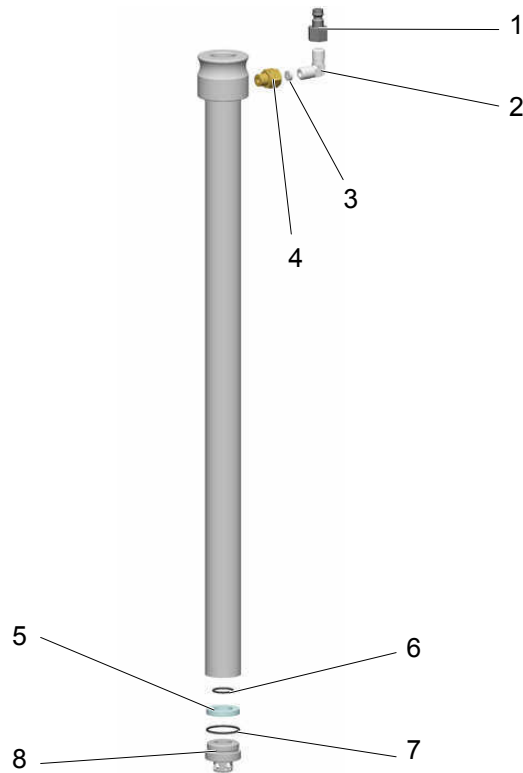

Fluidizing/suction unit - Ø 28 mm, complete	1005 332
1 Connector - NW5.0-1/8"i	200 859
2 Elbow joint - 1/8"a-1/8"a	235 733
3 Flow restrictor - Ø 0.3 mm	338 303
4 Adapter nipple - 1/8"i-1/8"a	200 930
Fluidizing ring set - incl. pos. 5, 6, 7	720 002#
5 Fluidizing ring	
6 O-ring - Ø 14x1.5 mm	
7 O-ring - Ø 22.1x1.6 mm	
8 Foot piece	1005 327

Wearing part

* Please indicate length

OptiSpeeder - complete

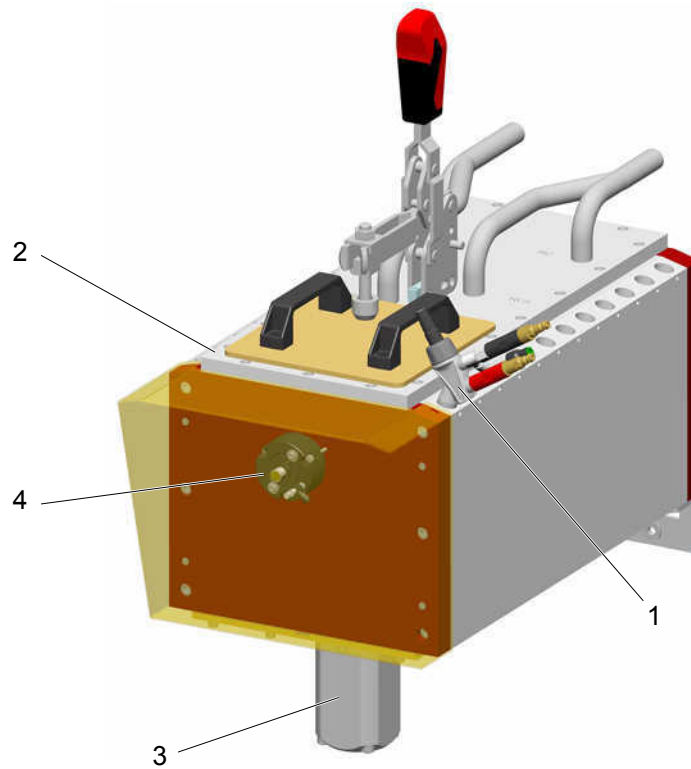

1	OptiFlow IG06-P injector - see corresponding operating manual	1007 779
2	OptiSpeeder cover - see corresponding spare parts list	
3	Pinch valve - DN32 G 1 1/4", complete	1007 648
4	Level sensor - see corresponding spare parts list	

OptiSpeeder

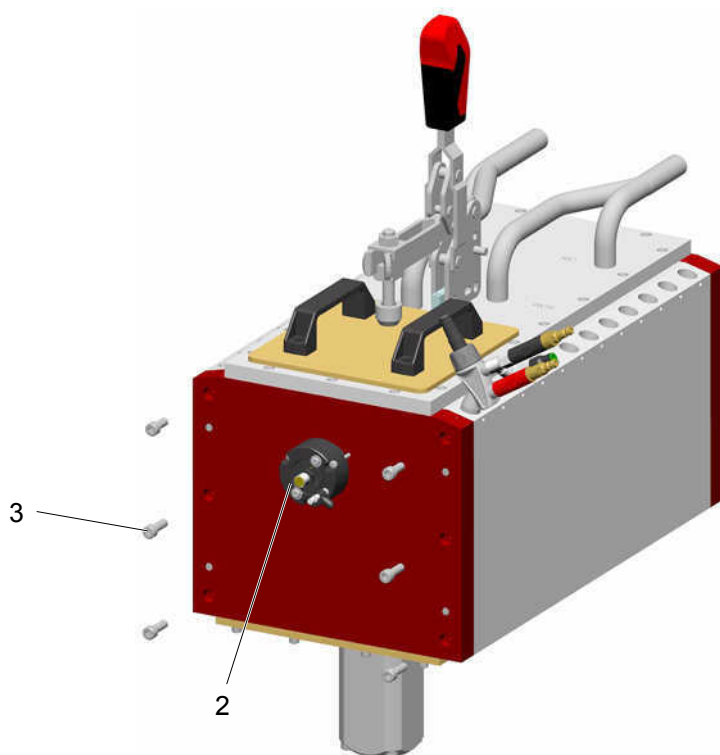

2 Level sensor - see corresponding spare parts list

3 Allen cylinder screw - M8x25 mm

248 436

OptiSpeeder - Cover

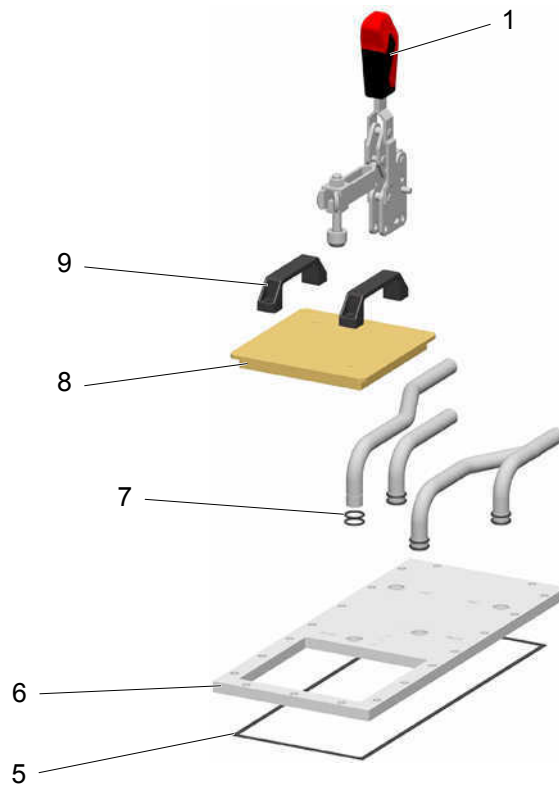

1	Toggle clamp - complete	1008 017
5	Gasket	1007 781
6	Cover	1007 924
7	O-ring - Ø 21x3 mm	214 981#
8	Cover	1007 927
8.1	O-ring for pos. 8 (not shown)	1008 063#
9	Grip	244 864
# Wearing part		

OptiSpeeder - Fluidizing plate

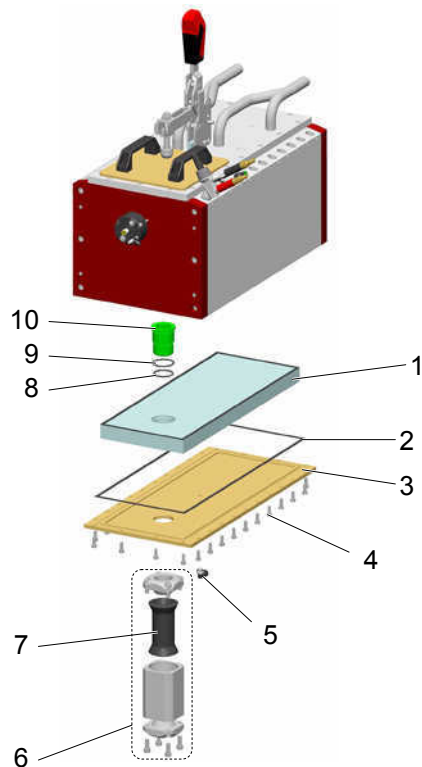

Bottom fluidizing plate set (incl. pos. 1, 4, 8, 9)	720 005
1 Bottom fluidizing plate - complete	#
2 Gasket	1007 831
3 Fastening plate	1007 786
4 Allen cylinder screw - M6x16 mm	
5 Elbow joint - 1/8"a-Ø 8 mm	251 372
6 Pinch valve - DN32 G 1 1/4", complete	1007 648
7 Pinch valve hose - NW32	1007 647#
8 O-ring - Ø 33x3 mm	#
9 O-ring - Ø 40x3 mm	#
10 Connector	1007 571#
# Wearing part	

OptiSpeeder - Level sensor

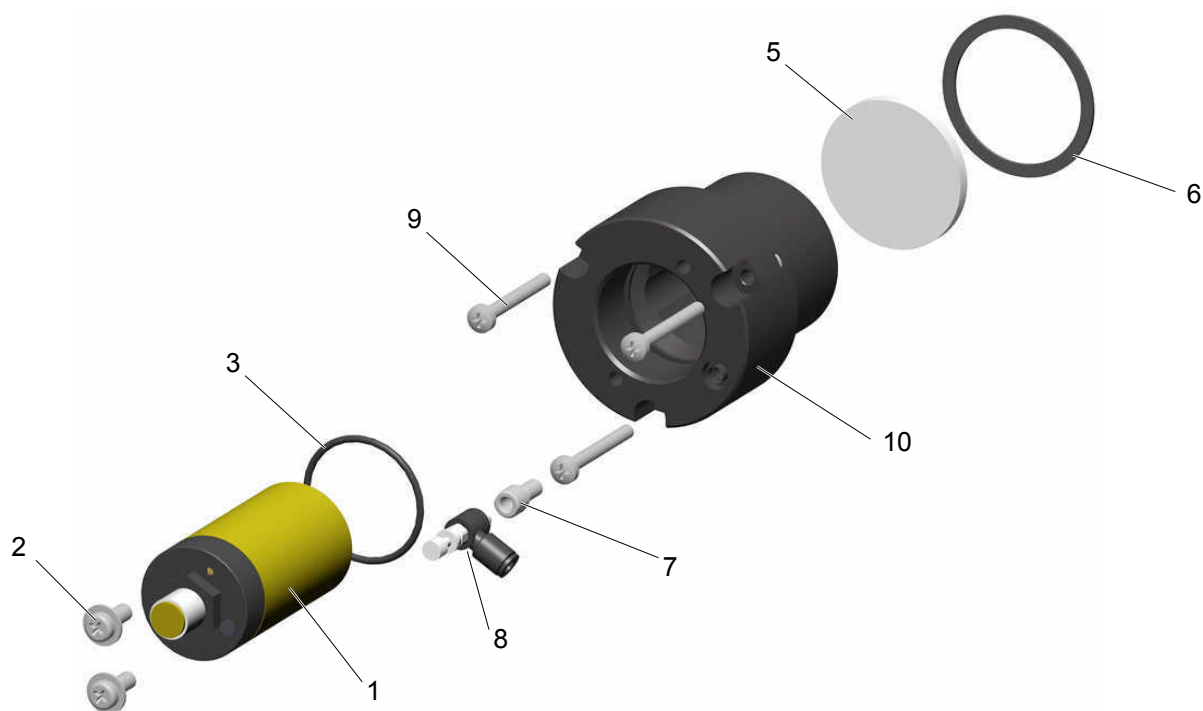

Level sensor set (incl. pos. 1, 2, 3)	720 003
1 Level sensor - N.O., 10...65 VDC	
2 Cap screw - M5x12 mm	
3 O-ring - Ø 34x2 mm	
4 Cable - for pos. 1 (not shown)	1005 498
Fluidizing plate set (incl. pos. 5, 6, 7, 8, 9)	720 004
5 Fluidizing plate - Ø 44x4 mm	#
6 Gasket - Ø 47.5x1 mm	#
7 Compressed air connector	
8 Throttle valve - Ø 4-M5x0.8 mm	
9 Cap screw - M4x35 mm	
10 Support	1005 644
# Wearing part	

OptiCenter - Pneumatics

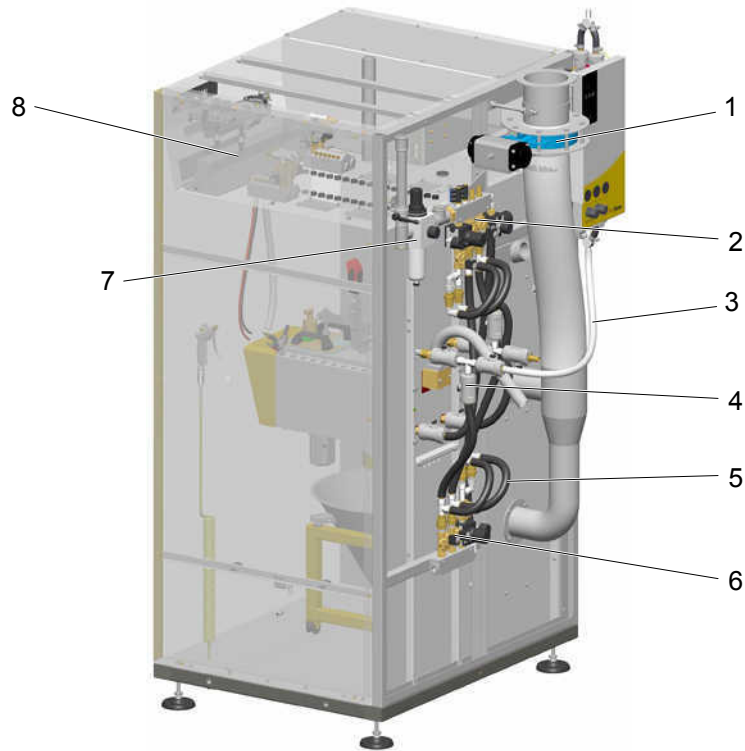

1 Butterfly valve - see corresponding spare parts list

2 Manifold - see corresponding spare parts list

3 Powder hose - Ø 16/23 mm 1003 307*#

4 Pinch valve - see corresponding spare parts list

5 Compressed air hose - Ø 16.4/26.6 mm 105 155*

6 Pneumatic manifold 2 - see corresponding spare parts list

7 Main air supply - see corresponding spare parts list

8 OptiCenter roof - see corresponding spare parts list

Wearing part

* Please indicate length

Main air supply

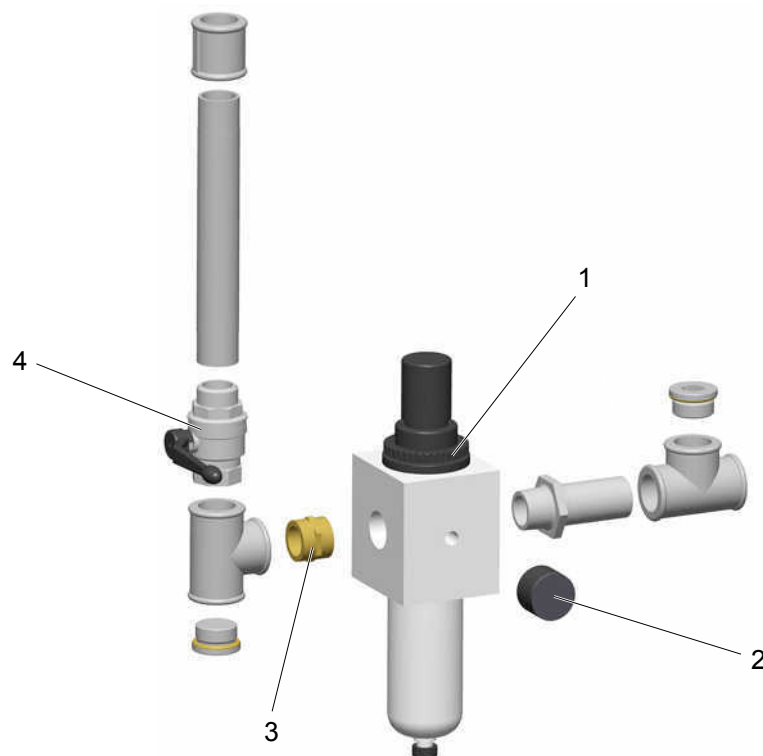

1	Pressure regulator/Filter unit - 1"i, 0,5-8 bar	1006 547
2	Pressure gauge - 1/8", 0-10 bar	259 179
3	Double nipple - 1"a-1"a	1003 544
4	Ball valve - 1"a-1"i	1006 065

OptiSpeeder - Pneumatic manifold

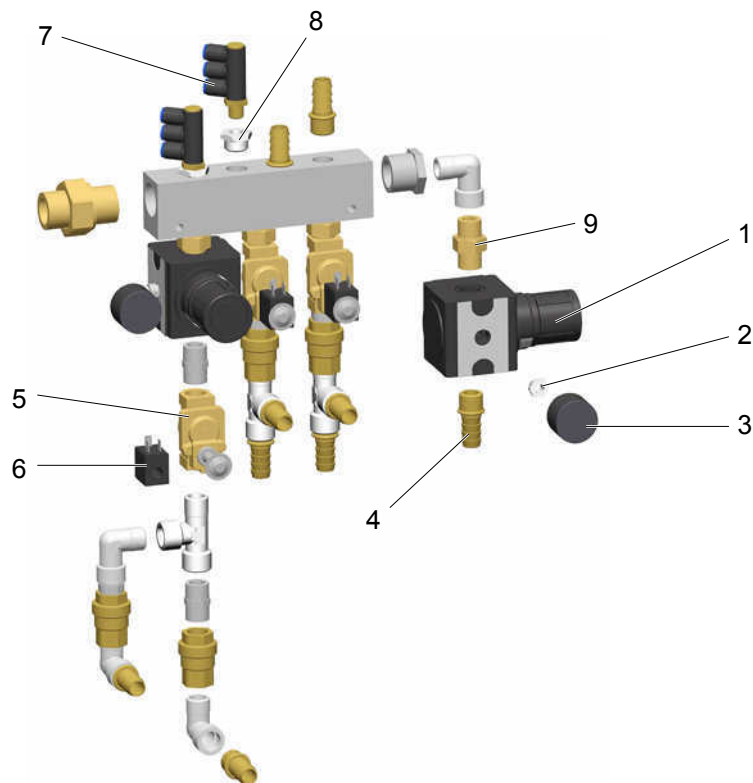

1	Pressure regulator - 1/2"i, 0.5-10 bar	259 187
2	Adapter nipple - 1/8i-1/4a	265 454
3	Pressure gauge - 1/8", 0-10 bar	259 179
4	Hose connector - Ø 16-1/2"a	259 268
5	Solenoid valve - 1/2", NW13.5 mm, without coil	1005 120
6	Valve coil - 24 VDC	1005 119#
7	Elbow joint - 1/4a-Ø 8/3 x 1 mm	1002 614
8	Adapter nipple - 1/4"i-1/2"a	253 995
9	Double nipple - 1/2"a-1/2"a, divisible	243 582

Wearing part

Pneumatic manifold Cleaning

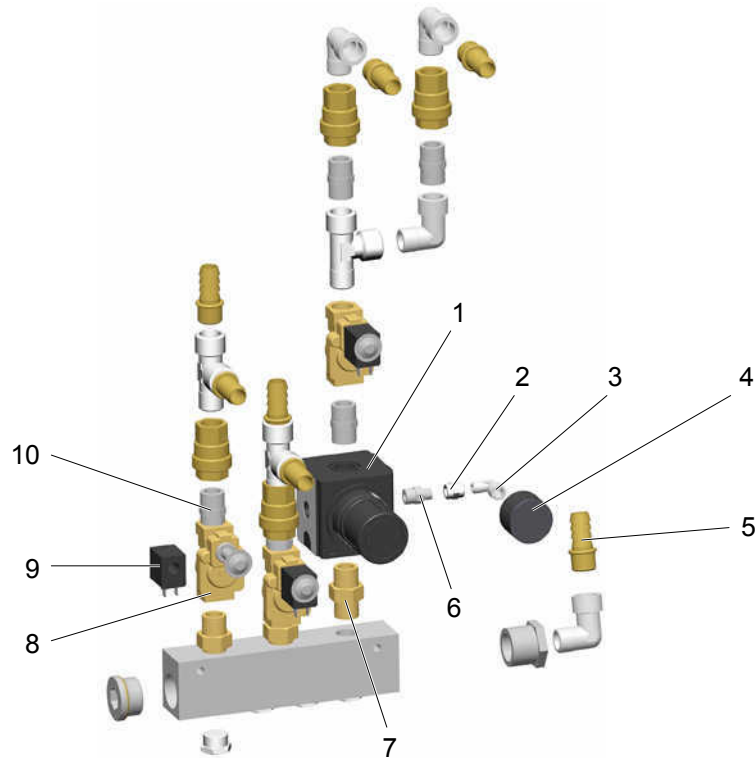

1	Pressure regulator - 1/2"i, 0.5-10 bar	259 187
2	Adapter - 1/8"i-1/8"i	259 551
3	Elbow joint – 1/8"a-1/8"i	237 604
4	Pressure gauge - 1/8", 0-10 bar	259 179
5	Hose connector - Ø 16 mm-1/2"a	259 268
6	Double nipple - 1/4"a-1/8"a	242 209
7	Double nipple - 1/2"a-1/2"a, divisible	243 582
8	Solenoid valve - 1/2", NW13.5 mm, without coil	1005 120
9	Valve coil - 24 VDC	1005 119#
10	Double nipple - 1/2"a-1/2"a	243 540

Wearing part

Pinch valve NW15

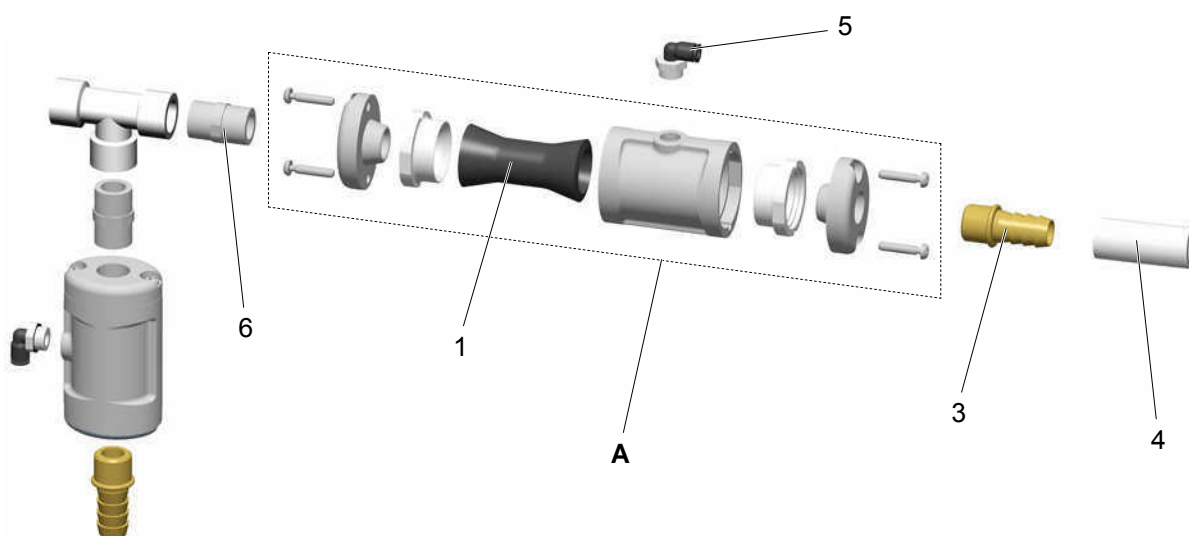

A	Pinch valve NW15 - complete	1006 255
1	Pinch valve sleeve NW15	1006 256#
3	Hose connector - Ø 16 mm-1/2"a	259 268
4	Powder hose - Ø 16/23 mm	1003 307#*
5	Elbow joint - 1/4"a-Ø 6 mm	265 691
6	Double nipple - 1/2"a-1/2"a	243 540

Wearing part

* Please indicate length

OptiCenter - Roof

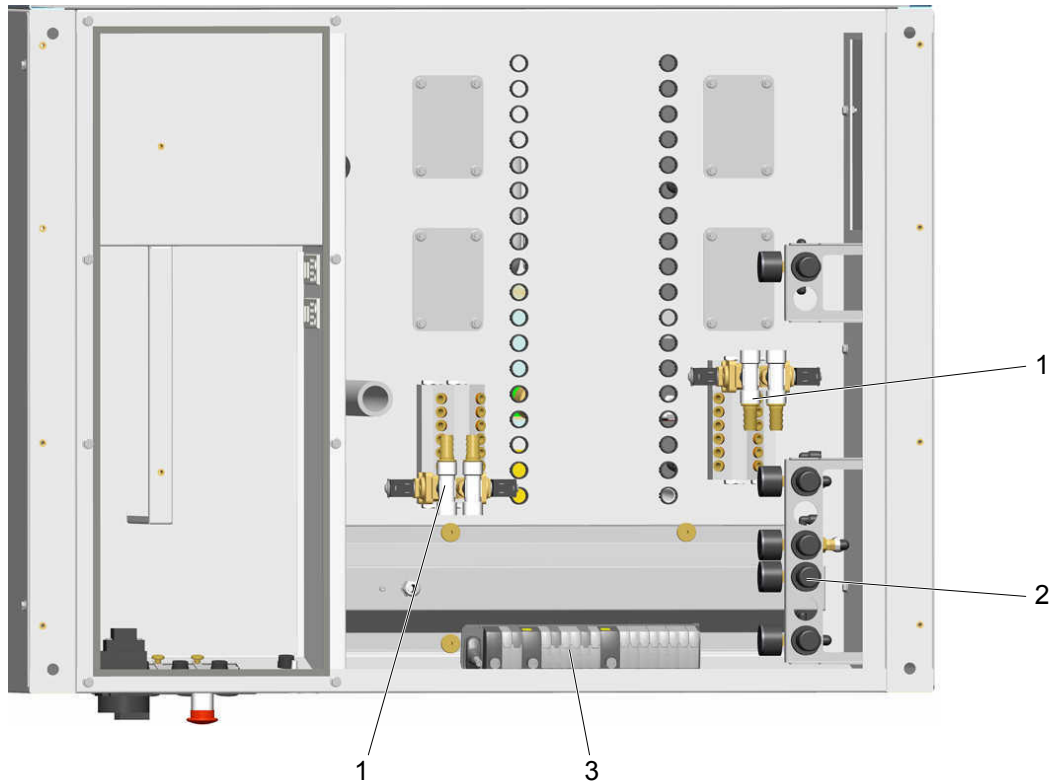

-
- 1 Shuttle valves pool - see corresponding spare parts list

 - 2 Pressure regulators pool - see corresponding spare parts list

 - 3 Valves pool - see corresponding spare parts list

Shuttle valves pool

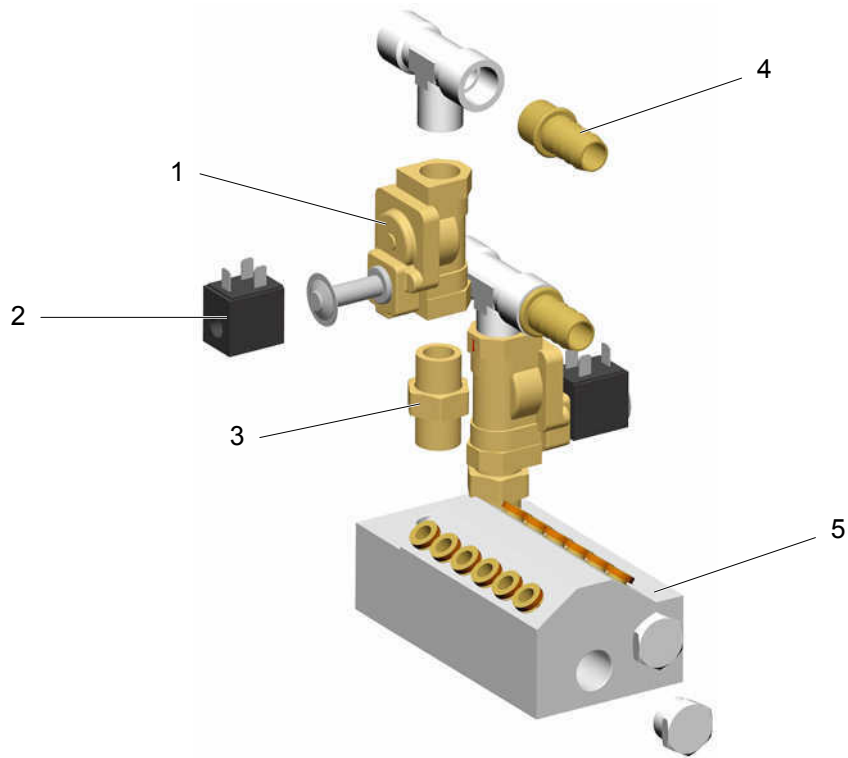

1	Solenoid valve - 1/2", NW13.5 mm, without coil	1005 120
2	Valve coil - 24 VDC	1005 119#
3	Double nipple - 1/2"a-1/2"a, divisible	243 582
4	Hose connector - Ø 16-1/2"a	259 268
5	Block	1007 388

Wearing part

Pressure regulators pool

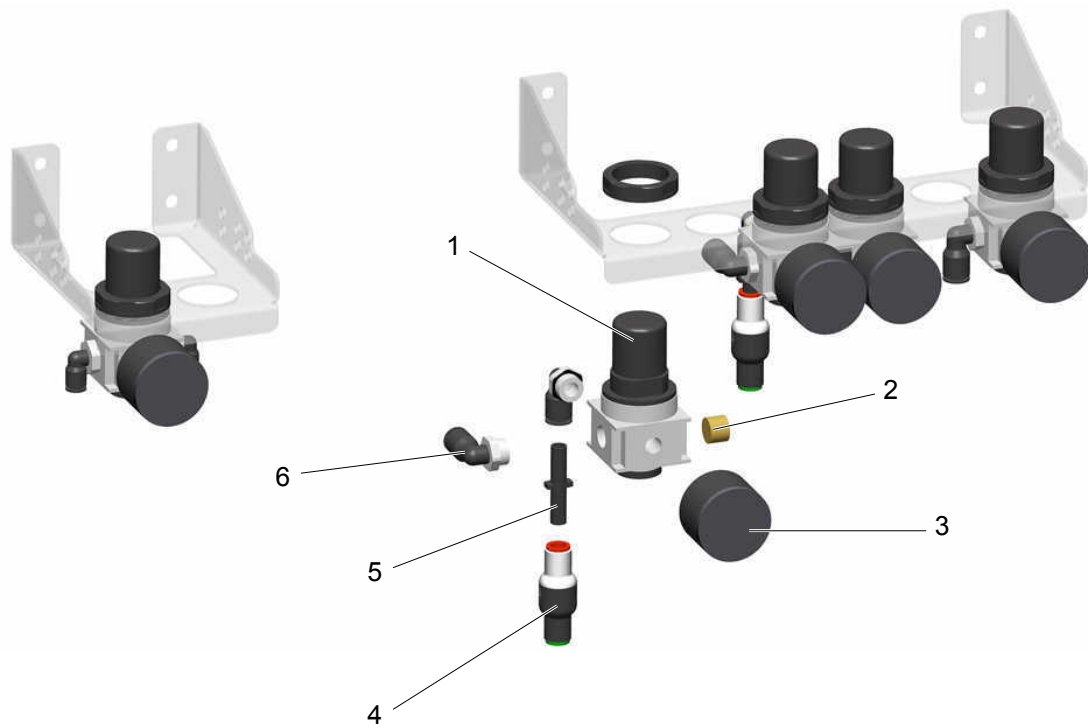

1	Pressure regulator - 1/4"i, 0.5-6 bar	264 342
2	Plug cap - 1/4"a	258 695
3	Pressure gauge - 1/8", 0-10 bar	259 179
4	Check valve - Ø 8-Ø 8 mm	1005 575
5	Double connecting nipple - Ø 8 mm	229 326
6	Elbow joint - 1/4"a-Ø 8 mm	254 029

Monocyclone - Powder transport

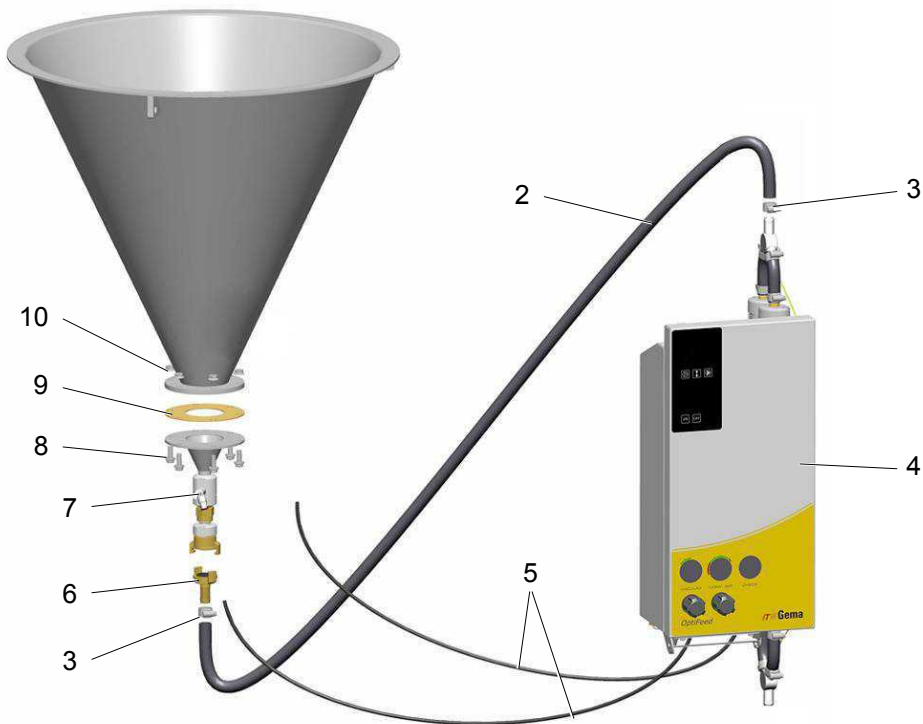

2	Powder hose - Ø 16/23 mm	1003 307#*
3	Hose clamp - 17-25 mm	223 085
4	OptiFeed PP06 Powder pump - see corresponding operating manual	
5	Plastic tube - Ø 6/4 mm	103 144*
6	GEKA coupling with grommet - Ø 16 mm	1003 872
7	Fluidizing unit - complete, see corresponding spare parts list	1005 507#
8	Allen cylinder screw - M8x20 mm	265 241
9	Gasket	395 439
10	Hexagon shakeproof nut - M8	244 449

Wearing part

Monocyclone - Powder transport connection

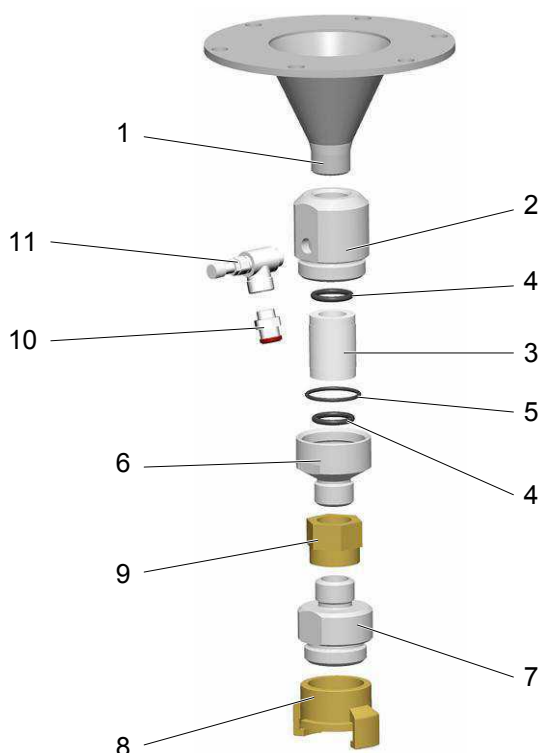

Powder transport connection - complete (pos. 1-11)	1005 652
1 Funnel piece	1005 502
1.1 Gasket - for pos. 1 (not shown)	395 439#
Fluidizing unit - complete (pos. 2-6)	1005 507
2 Connector	1005 504
Fluidizing tube set (incl. pos. 3, 4, 5)	720 006
3 Fluidizing tube	#
4 O-ring - Ø 17x3 mm	#
5 O-ring - Ø 26x2 mm	#
6 Locking piece	1005 506
7 Connecting piece	1005 503
8 GEKA coupling - 1"-IG	1000 854
9 Adapter - 1/2"-1/2"i	202 622
10 Screw-in nipple - 1/8"a-Ø 6 mm	240 095
11 Throttle valve - 1/8"-1/8"a	1002 127
# Wearing part	

Powder hopper

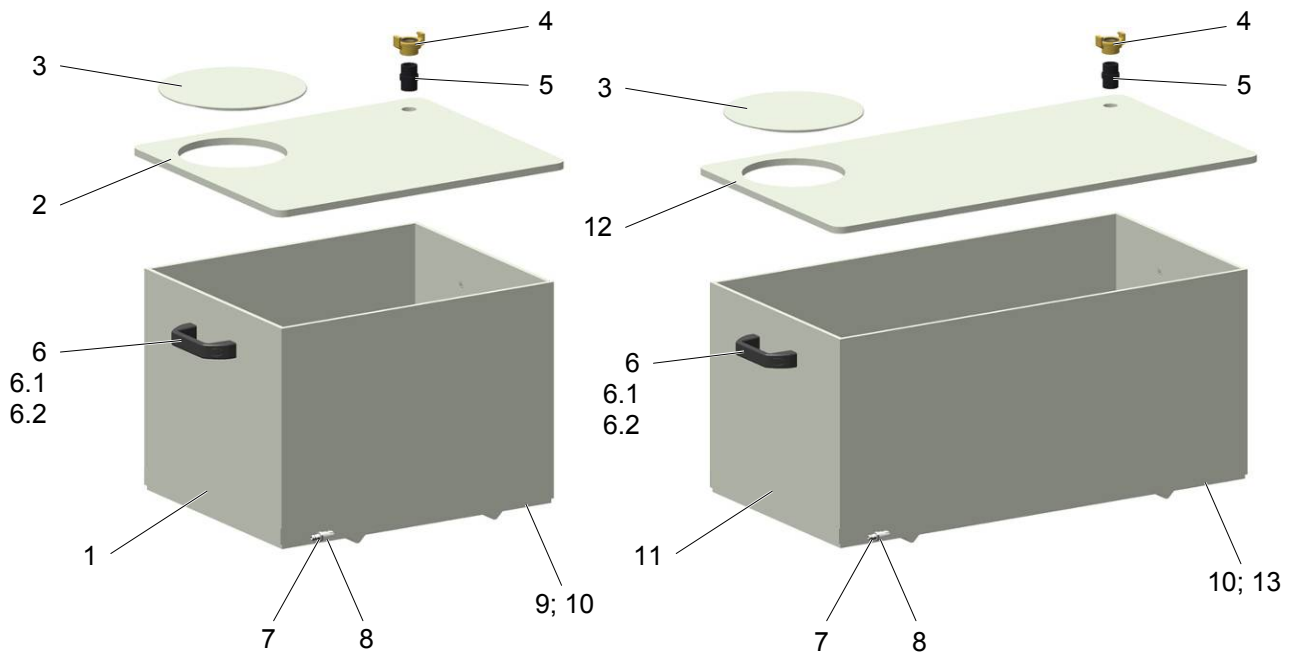

Powder hopper PH60-OC – complete (pos. 1-10)	1008 171
Powder hopper PH100-OC – complete (pos. 3-13)	1008 303
1 Powder hopper PH60-OC	1008 313
2 Cover PH60-OC	1008 194
3 Cover – round	1008 374
4 GEKA coupling – 3/4"	1002 551
5 Double nipple – 3/4"a-3/4"a	228 028
6 Grip	1006 013
6.1 Countersunk Allen screw – M6x25 mm	241 598
6.2 Hexagon nut – M6	205 095
7 Connector – NW5-1/8"a	237 272
8 Elbow joint – 1/8"a-1/8"i	237 604
9 Fluidizing plate PH60-OC (not shown)	1006 012
10 Countersunk Allen screw – M6x50 mm	1002 954
11 Powder hopper PH100-OC	1008 315
12 Cover PH100-OC	1008 304
13 Fluidizing plate PH100-OC (not shown)	1006 017
Blind cover PH60-OC (not shown)	373 907
Blind cover PH100-OC (not shown)	362 719
GEKA blind coupling – for pos. 4 (not shown)	1002 405

LC01 Level sensor

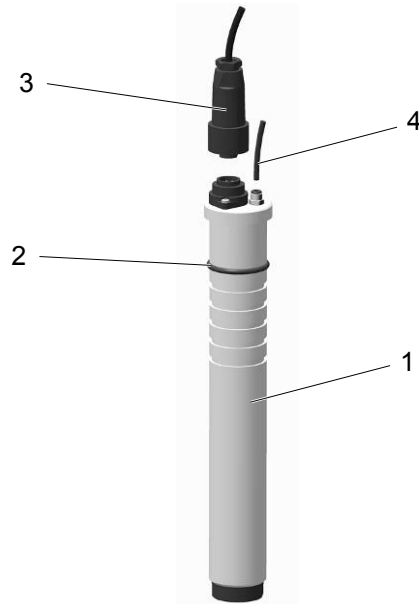

1	LC01 Level sensor - complete (incl. pos. 2)	1006 089
2	O-ring - Ø 38 x 4 mm	239 151#
3	Connecting cable - complete	371 696
4	Plastic tube - Ø 4/Ø 2 mm	104 051*

Wearing part

* Please indicate length

US06 Ultrasonic sieve

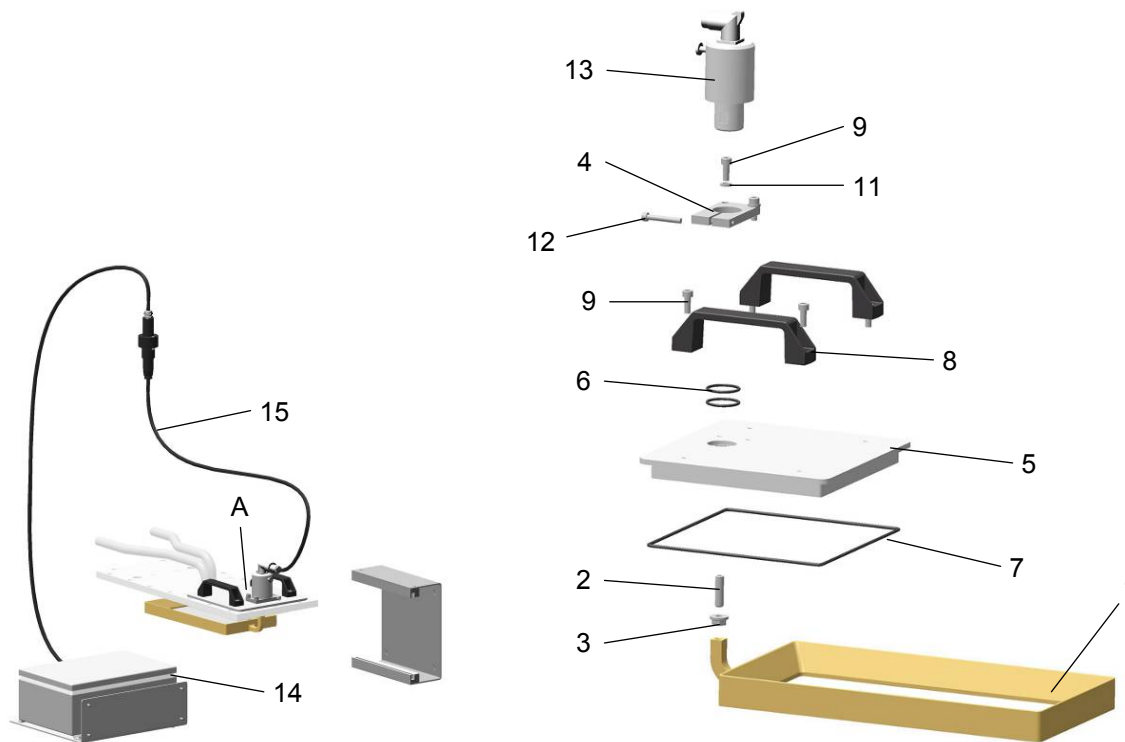

A US06 Ultrasonic sieve - complete (pos. 1-13)		Indicate project no.
1	Sieve 140 µm – complete (pos. 1-3)	1009 892#
	Sieve 200 µm – complete (pos. 1-3)	1009 893#
	Sieve 250 µm – complete (pos. 1-3)	1009 894#
	Sieve 300 µm – complete (pos. 1-3)	1009 865#
2	Allen grub screw – M8x35 mm	
3	Nut with flange – M8	
4	Terminal	1007 871
5	Cover	1007 870
6	O-ring - Ø 28 x 2.5 mm	263 842#
7	O-ring - Ø 219.5 x 3 mm	1008 063#
8	Grip	244 864
9	Allen cylinder screw – M6x16 mm	216 410
11	Shake proof washer – M6	216 054
12	Allen cylinder screw - M5x35 mm	1008 597
13	Converter	1007 869
14	Ultrasonic generator - 100 W	1008 178
15	Cable with coupling	1008 847
	Thread sealant – ERGO no. 4202	220 507

Wearing part

