

**BINKS**

PRODUCT CATALOG

# Fluid Handling Products



Maximize Production.  
**Optimize Results.**



Table of Contents

Pogo Pump: Drum Mounted Low Pressure Piston Pump ..... 3

Pressure Tanks: Stainless Steel, Zinc-Plated, & Galvanized ..... 4-5

DX70: Diaphragm Pump with Built-In Fluid Regulator ..... 6-7

Gemini II: Diaphragm Pumps For Spraying & Fluid Transfer Applications ..... 8-11

MX Medium Pressure Pumps ..... 12-13

MX Heavy Duty Pumps ..... 14-17

Ram Pumps ..... 18-19

Maple Pumps: Pneumatic Circulation Pumps ..... 20-21

Smart Pumps: Electric Circulation Pumps ..... 22-23

Fluid Regulators ..... 24

*Low Pressure* ..... 25

*Air Pilot* ..... 26

*Medium & High Pressure* ..... 27

*Back Pressure Regulators (Manual)* ..... 28

*Surge Eliminators & Air Piloted BPR* ..... 29

Agitators ..... 30-31



**Toll Free Customer Support and Technical Assistance**

800-992-4657 USA & Canada Only

**Toll Free Fax**

888-246-5732 USA & Canada Only

**MSDS sheets are available on the web**

[www.binks.com](http://www.binks.com)

# Binks Pogo Plus Low Pressure Pumps

For High Volume Fluid Transfer & Spray Applications

Pogo Plus series, two-ball, double acting piston pumps are designed for the application and transfer of low-medium viscosity fluids. Models are available in Stainless Steel with either PTFE or UHMWE packings and are compatible with a wide variety of materials including water or solvent borne paints and adhesives and most solvents. Pogo Plus pumps have a 4:1 ratio and are available with maximum pressure ratings of 290 psi or 500 psi.

**MARKETS & APPLICATIONS**

- Furniture and Wood Cabinets
- Truck and Bus
- Adhesive Applications
- Coating Supply
- Solvent Supply for 2K Equipment
- General Industry

*Binks Pogo Plus Low Pressure Pumps For High Volume Fluid Transfer & Spray Applications*

**Patented Air Motor Design**

- Utilize AX55 air motor to provide quick changeover and reduced pulsation

**Durable Pump Design**

- Reduces maintenance cost

**Pump Outfit Available with Trophy Gun**

- Trophy guns available with a new lightweight and ergonomic design

**5 Year Limited Warranty**

- The finishing industry's best warranty

Pogo Plus Outfits include PX1304-5U pump, gun, air control, air and fluid hose, and bung adaptor

**98-3063**

Pogo Outfit with Trophy Conventional gun 2465-18CN-11SO

**98-3062**

Pogo Outfit with 2101-4308-2 gun



PUMP PERFORMANCE	PX1304-5U	PX1304-5P	PX1304-8U	PX1304-8P
Pressure Ratio	4:1	4:1	4:1	4:1
Air Inlet Pressure (bar)	0-72.5 psi (5)	0-72.5 psi (5)	0-116 psi (8)	0-116 psi (8)
Fluid Pressure (bar)	0-290 psi (20)	0-290 psi (20)	0-500 psi (34)	0-500 psi (34)
Cycles Per Gallon	47	47	47	47
Displacement Per Cycle	2.7 (81 cc)	2.7 (81 cc)	2.7 (81 cc)	2.7 (81 cc)
Flow @60 Cycles/Min	1.3 gal (4.91 l/m)	1.3 gal (4.91 l/m)	1.3 gal (4.91 l/m)	1.3 gal (4.91 l/m)
Packing Material	UHMW	PTFE	UHMW	PTFE

SPRAY FINISHING OUTFITS	98-3063	98-3062
Pump	PX1304-5U	PX1304-5U
Gun	Trophy Conventional 2465-18CN-11SO	2101-4308-2
Air Control	41-28272	41-28272
Air Hose 25 Foot	71-4803	71-4803
Fluid Hose 25 Foot	71-3303	71-3303
Drum Bung Adaptor	41-28331	41-28331



**BINKS 5-YEAR WARRANTY**

Binks® warrants to the original end-use purchaser that Binks branded products shall not fail under normal use and service due to a defect in material or workmanship within five (5) years from the date of shipment from Binks. Does not include normal wear and tear parts.

Pressure Tanks

# Zinc-Plated & Stainless Steel 2.8 gal. Pressure Tanks

Binks ASME code PT tanks are a great choice in a 2 gallon pressure tank when spraying up to 80 psi of fluid pressure.

- Choose 83C tanks for solvent-borne coatings
- Choose 83Z tanks for water-borne coatings

AIR REGULATION	FLUID AGITATION	Zinc-Plated Throughout, Including Lid, Wetted Parts & Tank Shell	Zinc-Plated Tank Shell, Stainless Steel Lid & Wetted Parts
Single Reg	No Agitation	83C-210	83Z-210
Double Reg	No Agitation	83C-220	83Z-220
Single Reg	Std. Agitation (D)	83C-211	83Z-211
Double Reg	Std. Agitation (D)	83C-221	83Z-221
Disposable Liner	–	PT-78-K10 or K60	PT-78-K10 or K60
Head Gasket	–	PT-33-1	PT-33-1
Service Bulletin	–	SBBI-21-044	SBBI-21-043



w/2 Regulators  
PART NO.: 83C-220

w/Agitator  
(2 Regulators)  
PART NO.: 83C-221

NOTE: The air regulator(s) and gauge(s) are shipped inside the tank to prevent damage in shipping. Bottom outlet kits are not available for 83C or 83Z pressure tanks.  
(D) =Direct Drive Agitator: Uses direct mount air motor and air adjusting valve.

## GALVANIZED STEEL 2, 5, 10 and 15 GALLON PRESSURE TANKS

Binks 183G- ASME Code Tanks give you application flexibility for most solvent-borne applications.

ASME CODE GALVANIZED CARBON STEEL TANKS									
SINGLE REGULATED	DOUBLE REGULATED	SINGLE REGULATED WITH EXTRA SENSITIVE REGULATOR	DOUBLE REGULATED WITH EXTRA SENSITIVE REGULATOR	DIRECT DRIVE AGITATOR	20:1 GEAR REDUCED AGITATOR	2 GAL. TANK PART NO:	5 GAL. TANK PART NO:	10 GAL. TANK PART NO:	15 GAL. TANK PART NO:
✓						183G-200	183G-500	183G-1000	183G-1500
✓				✓		183G-210	183G-510	183G-1010	183G-1510
✓					✓	183G-211	–	–	–
	✓					183G-213	183G-513	183G-1013	183G-1513
	✓			✓		183G-220	183G-520	183G-1020	183G-1520
	✓					183G-221	–	–	–
	✓				✓	183G-223	183G-523	183G-1023	183G-1523
		✓		✓		183G-230	183G-530	183G-1030	183G-1530
		✓				183G-231	–	–	–
		✓			✓	183G-233	183G-533	183G-1033	183G-1533
			✓	✓		183G-240	183G-540	183G-1040	183G-1540
			✓	✓		183G-241	–	–	–
			✓		✓	183G-243	183G-543	183G-1043	183G-1543



All 183G Tanks Include Fill Port



2 gal.  
PART NO: 183G-210



5 gal.  
PART NO: 183G-523

# Stainless Steel 2, 5, 10 and 15 Gallon Pressure Tanks

Binks 183S- ASME Code Tanks give you application flexibility with our best chemical resistance. Suitable for water-borne coatings.

ASME CODE STAINLESS STEEL TANKS									
SINGLE REGULATED	DOUBLE REGULATED	SINGLE REGULATED WITH EXTRA SENSITIVE REGULATOR	DOUBLE REGULATED WITH EXTRA SENSITIVE REGULATOR	DIRECT DRIVE AGITATOR	20:1 GEAR REDUCED AGITATOR	2 GAL. TANK PART NO:	5 GAL. TANK PART NO:	10 GAL. TANK PART NO:	15 GAL. TANK PART NO:
						183S-200	183S-500	183S-1000	183S-1500
✓						183S-210	183S-510	183S-1010	183S-1510
✓				✓		183S-211	–	–	–
✓					✓	183S-213	183S-513	183S-1013	183S-1513
	✓					183S-220	183S-520	183S-1020	183S-1520
	✓			✓		183S-221	–	–	–
	✓				✓	183S-223	183S-523	183S-1023	183S-1523
		✓				183S-230	183S-530	183S-1030	183S-1530
		✓		✓		183S-231	–	–	–
		✓			✓	183S-233	183S-533	183S-1033	183S-1533
			✓	✓		183S-240	183S-540	183S-1040	183S-1540
			✓	✓		183S-241	–	–	–
			✓	✓	✓	183S-243	183S-543	183S-1043	183S-1543

## 30 & 60 GALLON TANKS

Binks ASME code 30 and 60 gallon tanks are ideal for larger jobs such as line stripping or supporting multiple guns. Choose galvanized units for most applications. Choose stainless steel fitted galvanized tanks for water-borne applications.

ASME CODE 30 & 60 GALLON TANKS					
SINGLE REGULATED	20:1 GEAR REDUCED AGITATOR	30 GALLON TANK IN GALVANIZED STEEL	60 GALLON TANK IN GALVANIZED STEEL	30 GALLON SHELL IN GALVANIZED STEEL (FOR A STAINLESS STEEL FITTED TANK)	60 GALLON SHELL IN GALVANIZED STEEL (FOR A STAINLESS STEEL FITTED TANK)
✓		83-5801	83-5701	83-5873 Plus 30 Gallon Liner (See Below)	83-5773 Plus 60 Gallon Liner (See Below)
✓	✓	83-5807	83-5707	83-5879 Plus 30 Gallon Liner (See Below)	83-5779 Plus 60 Gallon Liner (See Below)



30 & 60 GALLON TANK LINERS			
TOP OUTLET	BOTTOM OUTLET (INCLUDES BOTTOM OUTLET KIT)	30 GALLON SS LINER	60 GALLON SS LINER
✓	✓	83-1569 83-2230	83-1581 83-2229

### BOTTOM OUTLET KITS FOR 183G- & 183S- ASME CODE TANKS:

Bottom outlet kits include sturdy steel legs, mounting fasteners, fittings, and outlet pipe.

	BOTTOM OUTLET KIT	FLUID OUTLET IF USING BOTTOM OUTLET KIT
2 Gallon Tanks	183-3000	3/4" npt (m) or 3/4" nps (m)
5, 10 and 15 Gallon Tanks	183-3001	3/4" npt (m) or 3/4" nps (m)

183-3005: One leg plus fasteners. Order one to replace a damaged leg. Order three to raise a tank without bottom outlet plumbing.



Bottom Outlet

# DX 70

## Double Diaphragm Pumps



The Binks DX70 is the perfect solution for one gun spray applications with faster color changes and quick refills for less production downtime. The DX70 includes a built in fluid regulator which ensures a constant and virtually pulse free fluid delivery. The DX70 design reduces the cost and complexity of additional fluid regulators or surge chambers.

The DX70 pumps are 1:1 diaphragm pumps with a recommended flow rate up to 34 fl. oz/min (1000 cc/mn). Pump packages are available in several different mountings: cart, wall, pail, and tripod.

### BINKS DX70 FEATURES

#### Built in Fluid Regulator

- Reduces cost of addition fluid regulators and provides a constant and virtually pulse free fluid delivery

#### Unique Diaphragm design

- No-Crease design extends diaphragm pump life

#### Faster Color Changes

- Available with dump valve to quickly flush pump

#### Outfits Available with Trophy HVLP Gun

- Outfits have 1.0 mm, 1.4 mm, and 1.8 mm set ups

#### 5-Year Warranty

### RECOMMENDED MATERIALS

- Solvent Based Coatings
- Water Based Coatings
- Stains, Lacquers, Varnishes
- Sealers and Undercoats

### TYPICAL APPLICATIONS

- Woodworking
- Aerospace
- Agricultural and Off Road
- Marine Industry
- Truck and Bus



### BINKS 5-YEAR WARRANTY

Binks® warrants to the original end-use purchaser that Binks branded products shall not fail under normal use and service due to a defect in material or workmanship within five (5) years from the date of shipment from Binks. Does not include normal wear and tear parts.

## Double Diaphragm Pump

### PUMP SPECIFICATIONS

DX70 PUMP SPECIFICATION (BARE PUMP)	DESCRIPTION
Pump Ratio	1 to 1
Max Air Pressure	100 psi/7 bar
Nominal Flow Volume/Cycle	0.018 gal (0.07 L)
Fluid Output@60 Cycles/min	1.1 gal/min (4.2 l/min)
Max Recommended Continuous Cycle Rate	10 cycles/min
Max Recommended Intermittent Cycle Rate	30 cycles/min
Inlet Fluid Connection	3/8" Universal (BSPP/NPSM) Male or Female
Outlet Fluid Connection	3/8" Universal (BSPP/NPSM) Male or Female
Maximum Dry/Wet Lift	21.8 feet (6.6 m)
Air Inlet	1/4" (BSPP) Female
Air Volume /cycle@100 psi	0.027 SCFM
Air Volume 10 cycles/min 100 psi/6.9 cycles	0.27 SCFM/min
Air Volume 30 cycles/min 100 psi/6.9 cycles	0.82 SCFM/min
Noise Level	68 dB
Weight	4.9 lbs (2.2 kg)

DX70R3-WF  
Wall mounted pump with paint filter and three air controls (Pail not included).



DX70R3-TF  
Tripod mounted pump outfit with three air controls.



### DX70 READY ASSEMBLED SPRAY OUTFITS INCLUDE SPRAY GUN

OUTFIT NUMBER	PUMP PART NUMBER	MOUNT	TROPHY GUN PART NUMBER	
98-3221	DX70R3-PF	Pail	2465-HV1	Outfits include Trophy HVLP Spray Gun with 1.0 mm, 1.4 mm, and 1.8 mm set ups, 25' Ergoflex Hose, and 25' Fluid Hose.
98-3224	DX70R3-PFA	Pail w/agitator	2465-HV1	
98-3226	DX70R3-CF	Cart	2465-HV1	
98-3227	DX70R3-TF	Tripod	2465-HV1	
98-3228	DX70R3-WF	Wall	2465-HV1	

### DESIGN YOUR DX70 PUMP PACKAGE

DX70 PUMP PACKAGE CONTENTS AND PART NUMBERS	DX70R3-PF	DX70R3-PFA	DX70R3-CF	DX70R3-CFG	DX70R3-WF	DX70R3-TF	DX70R3-TFG
DX-70 Bare Pump	✓	✓	✓	✓	✓	✓	✓
Fluid Regulator	✓	✓	✓	✓	✓	✓	✓
Filter Assembly	✓	✓	✓	✓	✓	✓	✓
Air Controls 3 Regulators	✓	✓	✓	✓	✓	✓	✓
Siphon Hose	✓	✓	✓	✓	✓	✓	✓
Agitator		✓					
Gravity Feed 1.4 gal (6L) Hopper				✓			✓
Pail Mount	✓	✓					
Tripod Mount						✓	✓
Cart Mount			✓	✓			
Wall Mount					✓		

DX70R3-CFG  
Cart mounted pump with 1.4 gal (6L) gravity bucket feed, filter and three air controls.



DX70R3-PFA  
Pail mounted pump with agitator, filter and three air controls (Pail not included).



# Gemini™ II Series

## Double Diaphragm Pumps

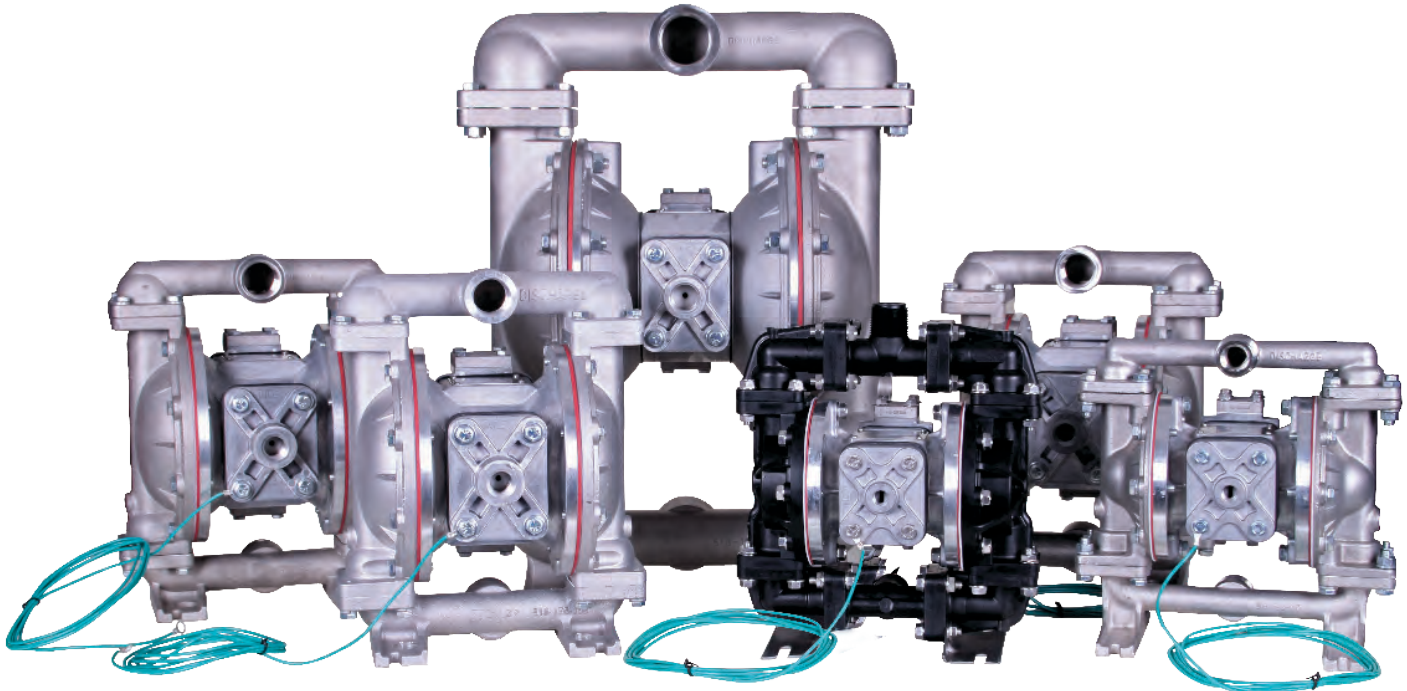

### Up to 38% More Fluid Delivery Per Stroke

- Longer equipment life and lower maintenance costs

### Short Stroke Pump Specifically Designed for Spraying Applications

- Pulsation reduction is greater than competition

### Customized Pump Packages

- Design a pump package for a specific application

### Pump Outfits with Trophy Guns

- Trophy guns available with a new lightweight and ergonomic design

### 5-Year Limited Product Warranty

- The finishing industry's best warranty

Binks Gemini II Diaphragm Pumps are the premier pumps for spraying, transferring, or circulating a variety of coatings. The pump design provides consistent spray patterns for high quality finish applications. The Gemini II pumps are rugged and designed to provide longer pump life.

### ■ Applications

The Binks Gemini II Diaphragm Pumps are ideal for a variety of materials and viscosities. Gemini II pumps can be used in applications including Wood, General Metal Fabrication, and Adhesives.



### BINKS 5-YEAR WARRANTY

Binks® warrants to the original end-use purchaser that Binks branded products shall not fail under normal use and service due to a defect in material or workmanship within five (5) years from the date of shipment from Binks. Does not include normal wear and tear parts.



## Double Diaphragm Pumps



41-818836  
½" Acetal



41-818831  
½" Acetal  
Short Stroke



41-818830  
½" Stainless

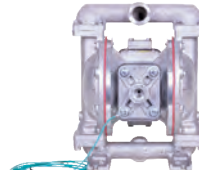

41-818820  
1" Aluminum

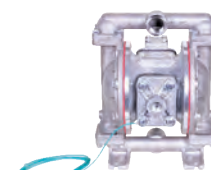

41-818822  
41-818823(BSP)  
1" Stainless



41-818810  
1 ½" Stainless

## Specifications

Gemini II Pumps	41-818836 ½" Acetal	41-818831 ½" Acetal Short Stroke	41-818830 ½" Stainless	41-818820 1" Aluminum	41-818822 41-818823(BSP) 1" Stainless	41-818810 1 ½" Stainless
Air Inlet Pressure Range	0-100 PSI	0-100 PSI	0-125 PSI	0-125 PSI	0-125 PSI	0-125 PSI
Air Inlet Size	¼" NPT	¼" NPT	¼" NPT	½" NPT	½" NPT	¾" NPT
Max Fluid Pressure	100 PSI (6.9 bar)	100 PSI (6.9 bar)	125 PSI (8.6 bar)	125 PSI (8.6 bar)	125 PSI (8.6 bar)	125 PSI (8.6 bar)
Fluid Inlet/Outlet	½" NPT	½" NPT	½" NPT	1" NPT	1" NPT	1 ½" NPT
Max Flow Rate	14 gpm (52 lpm)	7.5 gpm (28 lpm)	14 gpm (52 lpm)	45 gpm (170 lpm)	45 gpm (170 lpm)	106 gpm (401 lpm)
Maximum Suction Lift	13 ft (3.9 m)	8 ft (2.4 m)	12 ft (3.6 m)	17 ft (5.1 m)	17 ft (5.1 m)	22 ft (6.7 m)
Max Particle Size	0.125" (3 mm)	0.125" (3 mm)	0.125" (3 mm)	.25" (6 mm)	.25" (6 mm)	.25" (6 mm)
Max Temperature Limits	180 F (82 C)	180 F (82 C)	220 F (104 C)	220 F (104 C)	220 F (104 C)	220 F (104 C)
Flow @ 60 Cycles/Min	3.12 gal (11 liters)	1.68 gal (6 liters)	3.12 gal (11 liters)	13.2 gal (50 liters)	13.2 gal (50 liters)	49.2 gal (186 liters)
Cycles Per Gallon	19.2	35.7	19.2	4.5	4.5	1.2
Displacement Per Cycle	.052 gal (.196 L)	0.028 gal (.105 L)	.052 gal (.196 L)	.22 gal (.84 L)	.22 gal (.84 L)	.82 gal (3.0 L)
Noise Level With Muffler	84 dBA Max	92 dBA Max	84 dBA Max	92 dBA Max	92 dBA Max	95 dBA Max
Weights	14 lbs (6.4 kg)	14 lbs (6.4 kg)	21 lbs (9.5 kg)	28 lbs (12.7 kg)	43 lbs (19.5 kg)	95 lbs (43.0 kg)

### Repair Kits:

Air End Seal Kit	41-718850	41-718850	41-718850	41-718855	41-718855	41-718858
Diaphragm Kit	41-718853	41-718861	41-718851	41-718856	41-718856	41-718860
Ball & Seal Kit	41-718854	41-718854	41-718852	41-718857	41-718857	41-718859
Operation Manual	77-2998	77-2995	77-2997	77-2994	77-2994	77-2993

### PART NO. ACCESSORIES

#### Mountings

41-718810	Pail Lid
41-718800	Wall Bracket
41-718815	Drum Lid Assembly

#### Siphon

41-2296	5 gal. Alum/Steel Siphon kit for 1" pump
41-10467	55 gal. Galvanized Siphon kit for 1" pump

#### Agitator

41-3312-S	5-gallon Agitator Assembly	71-31101	25' Ergoflex Air Hose 1/4" ID with 1/4" NPD(f) Swivel Connections
		71-3303	25' Fluidall Hose 3/8" ID with 3/8" NPS(f) Swivel Connections

#### Air & Fluid Hoses

#### Accessories

84-320	SS Fluid Regulator
41-9000	Drum Elevator
0114-011798	Replacement Grounding Kit

### 1" GEMINI II DIAPHRAGM PUMP PACKAGES

<b>PART NO.</b>	<b>41-818120</b>
	<b>Package Contains</b>
41-818820	1" Aluminum Gemini II Pump
41-718800	Wall Mount
41-718808	Dual Air Control
84-320	Fluid Regulator
<b>PART NO.</b>	<b>41-818121</b>
	<b>Package Contains</b>
41-818822	1" Stainless Steel Gemini II Pump
41-718800	Wall Mount
41-718808	Dual Air Control
84-320	Fluid Regulator

# Gemini™ II Pump Packages

Customize a Pump Package for Your Specific Application

■ **Ordering Information**

Select your mounting option. Then select the desired attributes from the chart below ("A" through "F" option) and build the Binks Gemini II system number that meets your particular production needs (½" pumps only).

**Select Your Mounting Options**

- P = Pail
- W = Wall
- D = Drum

	<b>A</b>	<b>B</b>	<b>C</b>	<b>D</b>	<b>E</b>	<b>F</b>
<b>GEM2-P</b>	<b>2</b>	<b>D</b>	<b>1</b>	<b>D</b>	<b>6</b>	<b>1</b>

<b>A</b>	<b>PUMP</b>
1	= ½" Acetal 41-818836
2	= ½" Acetal Short Stroke 41-818831
3	= ½" Stainless Steel 41-818830
<b>B</b>	<b>AIR CONTROL</b>
0	= None
S	= Single Air Control 41-718805
D	= Dual Air Control 41-718806
<b>C</b>	<b>BYPASS</b>
0	= None
1	= Bypass Filter/Pulse Assembly Pail or Drum Mount 41-718812-1
2	= Bypass Filter/Pulse Assembly 5 Gallon Wall Mount 41-718812-2
3	= Bypass Filter/Pulse Assembly 55 Gallon Wall Mount 41-718812-3
<b>D</b>	<b>AGITATOR</b>
0	= None
D	= Stainless Steel Direct Drive 41-3312-S
G	= Stainless Steel Gear Reduced Drive (Drum Mount Only) 31-400
<b>E</b>	<b>SIPHON</b>
0	= None
1	= Polypropylene Siphon Tube, Drum Mount 41-718813-33
2	= Polypropylene Siphon Tube, Pail Mount 41-718813-12
3	= Polypropylene Suction Hose Assembly Wall Mount 5 Gallon 41-718818-5
4	= Polypropylene Suction Hose Assembly Wall Mount 55 Gallon 41-718818-55
5	= Stainless Steel Siphon Tube, Drum Mount 41-718817-33
6	= Stainless Steel Siphon Tube, Pail Mount 41-718817-12
7	= Stainless Steel Suction Hose Assembly Wall Mount 5 Gallon 41-718819-5
8	= Stainless Steel Suction Hose Assembly Wall Mount 55 Gallon 41-718819-55
<b>F</b>	<b>FLUID REGULATOR</b>
0	= None
1	= Stainless Steel Fluid Regulator 84-320

**MULTIPLE MOUNTING CONFIGURATIONS:**

WALL • PAIL • DRUM

■ **Options to customize for your specific applications**



Double Diaphragm Pumps

# Gemini™ II Outfits

- All outfits have 25' Eroflex air hose and 25' fluid hose
- 2101 guns include complete gun set up



■ **Pail Mount Outfit with Agitator GEM2-P2D1D60 Includes**

½" Acetal Short Stroke Pump, Dual Air Control, Bypass Filter/Pulse Assembly, Agitator

Gemini II Outfit #	Spray Gun Part #	Spray Gun Description	Pump Package Part #
98-3200	2465-14HV-32S0	Trophy HVLP 1.4 mm, SS Needle	GEM2-P2D1D60
98-3201	2101-3100-0	Model 2101, CONV, 1.4 mm	GEM2-P2D1D60
98-3202	2465-14LV-23S0	Trophy LVMP 1.4 mm, SS Needle	GEM2-P2D1D60
98-3203	2465-12HV-32S0	Trophy HVLP 1.2 mm, SS Needle	GEM2-P2D1D60
98-3204	2101-0000-0	Model 2101, CONV, 1.0 mm	GEM2-P2D1D60

■ **Pail Mount Outfit GEM2-P2D1060 Includes**

½" Acetal Short Stroke Pump, Dual Air Control, Bypass Filter/Pulse Assembly

Gemini II Outfit #	Spray Gun Part #	Spray Gun Description	Pump Package Part #
98-3205	2465-14HV-32S0	Trophy HVLP 1.4 mm, SS Needle	GEM2-P2D1D60
98-3206	2101-3100-0	Model 2101, CONV, 1.4 mm	GEM2-P2D1D60
98-3207	2465-14lv-23S0	Trophy LVMP 1.4 mm, SS Needle	GEM2-P2D1D60
98-3208	2465-12HV-32S0	Trophy HVLP 1.2 mm, SS Needle	GEM2-P2D1D60
98-3209	2101-0000-0	Model 2101, CONV, 1.0 mm	GEM2-P2D1D60

■ **Wall Mount Outfit GEM2-W2D2070 Includes**

½" Acetal Short Stroke Pump, Dual Air Control, Bypass Filter/Pulse Assembly, 5-Gal Siphon

Gemini II Outfit #	Spray Gun Part #	Spray Gun Description	Pump Package Part #
98-3210	2465-14HV-32S0	Trophy HVLP 1.4 mm, SS Needle	GEM2-W2D2070
98-3211	2101-3100-0	Model 2101, CONV, 1.4 mm	GEM2-W2D2070
98-3212	2465-14lv-23S0	Trophy LVMP 1.4 mm, SS Needle	GEM2-W2D2070
98-3213	2465-12HV-32S0	Trophy HVLP 1.2 mm, SS Needle	GEM2-W2D2070
98-3214	2101-0000-0	Model 2101, CONV, 1.0 mm	GEM2-W2D2070

■ **Wall Mount Outfit GEM2-W2D3080 Includes**

½" Acetal Short Stroke Pump, Dual Air Control, Bypass Filter/Pulse Assembly, 55-Gal Siphon

Gemini II Outfit #	Spray Gun Part #	Spray Gun Description	Pump Package Part #
98-3215	2465-14HV-32S0	Trophy HVLP 1.4 mm, SS Needle	GEM2-W2D3080
98-3216	2101-3100-0	Model 2101, CONV, 1.4 mm	GEM2-W2D3080
98-3217	2465-14lv-23S0	Trophy LVMP 1.4 mm, SS Needle	GEM2-W2D3080
98-3218	2465-12HV-32S0	Trophy HVLP 1.2 mm, SS Needle	GEM2-W2D3080
98-3219	2101-0000-0	Model 2101, CONV, 1.0 mm	GEM2-W2D3080

Air Assisted & Airless Outfits

# Binks MX Medium Duty Series

## Ideal for Air Assist Airless Spray Finishing



Available as bare pumps or packages customized to your application.

The MX Medium Duty Piston Pumps are for air assist airless applications and are available in ratios of 12:1 and 31:1 with output of either 0.4 GPM or 1.2 GPM.

Binks MX series of piston pumps provide the industry's most responsive air motor and fluid section combination. Delivering excellent application results, Binks MX pumps reduce coating costs and energy consumption, lowering operational costs overall with fewer rejected parts.

### BINKS MX SERIES FEATURES

#### Patented Air Valve Technology

- Enables pump to change over quickly to significantly reduce pulsation

#### Long Lasting Ceramic Coated Piston Rods

- Resists wear from highly abrasive fluids and last up to 3X longer than hard chrome pistons

#### Supports 1 to 2 spray guns

- Handles thin to medium viscosity coatings

### BINKS MX MEDIUM DUTY SERIES PERFORMANCE DATA

SPECIFICATIONS	MX412	MX432	MX1212	MX1231
Pressure Ratio	12:1	32:1	12:1	31:1
Flow Rate at 60 cycles per min.	0.4 GPM	0.4 GPM	1.2 GPM	1.2 GPM
Displacement per cycle	0.8 OZ. (24 cm3)	0.8 OZ. (24 cm3)	2.4 OZ. (72 cm3)	2.4 OZ. (72 cm3)
Inlet Fluid Connection	1/2" nps (m)	1/2" nps (m)	3/4" nps (m)	3/4" nps (m)
Outlet Fluid Connection (Pump)	3/8" nps (m) or bps (m)	3/8" nps (m) or bps (m)	3/8" nps (m) or bps (m)	3/8" nps (m) or bps (m)
Outlet Fluid Connection (Filter)	1/4" nps (m) or bps (m)	1/4" nps (m) or bps (m)	1/4" nps (m) or bps (m)	1/4" nps (m) or bps (m)
Air Connections (Filter)	1/4" nps (m) or bps (m)	1/4" nps (m) or bps (m)	1/4" nps (m) or bps (m)	1/4" nps (m) or bps (m)
Wetted Parts	Stainless Steel, Hard Chrome, Nylon, PTFE, UHMWPE, Tungsten Carbide (MX412, MX432, MX1212 & MX1231)			
Max Fluid Pressure with included Air Motor	1390 PSI (96 BAR)	3712 PSI (256 BAR)	1390 PSI (96 BAR)	3596 PSI (248 BAR)
Air Consumption at 20 Cycles per min.	2.2 SCFM	5.2 SCFM	5.2 SCFM	17.6 SCFM
Noise	88 dB	96 dB	96 dB	97 dB
Max Air Inlet Pressure	116 PSI (8 BAR)	116 PSI (8 BAR)	116 PSI (8 BAR)	116 PSI (8 BAR)



### BINKS 5-YEAR WARRANTY

Binks® warrants to the original end-use purchaser that Binks branded products shall not fail under normal use and service due to a defect in material or workmanship within five (5) years from the date of shipment from Binks. Does not include normal wear and tear parts.

## Air Assisted & Airless Outfits

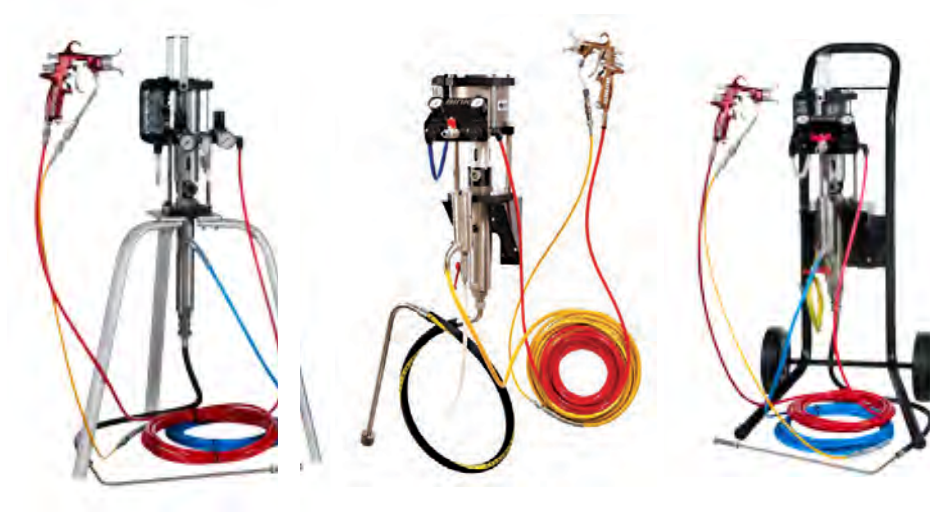

### MX PUMP PACKAGE ORDERING

Customize a Binks MX package for your specific application. MX outfits are complete and ready for operation with air control, siphon, and gun. Choose from the components below to build your pump.

#### Ordering Example: MX412UC-EDW1S25

MX412 12:1 pump with UHMWPE-U-Cup Seals, AA1600M 114-01310 Flat Tip Gun, Air Assist Air Control, Wall Mount, SS (stainless steel) Filter, 5-gal Siphon, 25' Hose

**A B C D E F G H**

**MX 412 UC - E D W 1 S 25**

### BINKS MX ACCESSORIES & SPARES

#### Spray Guns

0909-1600-HF1310	AA1600 Gun Assembly Flat Tip
0909-1600-HFT0613	AA1600 Gun Assembly Twist Tip
0909-4400-HF0000	AA4400 Gun Assembly Flat Tip
0909-4400-HT0000	AA4400 Gun Assembly Twist Tip
0811-7500-1	Airless 75 Gun Assembly

#### Hose Assemblies

71-4803	Air Hose Assembly (3/8" X 25ft)
71-4804	Air Hose Assembly (3/8" X 50ft)
71-4995	Fluid Hose 1,900 psi 3/16" ID X 25 ft

#### Mountings

0115-010179	Wall Mount
0115-010186	Cart Mount
0115-010100	Tripod Mount

#### Siphon

41-17260	5-Gallon Siphon
0115-010381	55-gallon Siphon

#### Filter

0115-010326	Filter Assembly 100 mesh
-------------	--------------------------

#### A Base Pump

412	=	0.4 GPM 12:1
432	=	0.4 GPM 32:1
1212	=	1.2 GPM 12:1
1231	=	1.2 GPM 31:1

#### B Packings

PL	=	PTFE/Leather Packings
PP	=	PTFE Packings
PU	=	PTFE/UHMWPE Packings
UC	=	UHMWPE-U-Cup Seals

#### C Gun

0	=	No Gun
E	=	AA1600M Flat Tip Gun
F	=	AA1600M Twist Tip Gun
G	=	AA4400M Flat Tip Gun
H	=	AA4400M Twist Tip Gun

#### D Air Control

D	=	Air Assist
---	---	------------

#### E Mounting

0	=	No Mounting
C	=	Cart Mount
T	=	Tripod Mount
W	=	Wall Mount

#### F Filter

0	=	No Filter
1	=	SS Filter

#### G Siphon

0	=	No Siphon
S	=	5 Gal
T	=	55 Gal

#### H Hoses

00	=	No Hose
25	=	25' Hose
50	=	50' Hose

# Binks MX Heavy Duty Series

## Airless and Air Assisted Airless Spray Outfits



Binks MX Pumps are a completely new design in air operated pump technology utilizing a patented magnetic detents to provide fast changeover with virtually no pulsation. The result is paint delivery with less pulsation for a more consistent finish.

The MX pistons are Ceramic coated which is the most durable surface available for resisting wear to high abrasive products. The MX Heavy Duty pumps are available in ratios of 35:1, 42:1, 60:1, and 70:1 with outputs of 3.0 GPM and 3.5 GPM.

### RECOMMENDED MATERIALS

- Solvent coatings
  - Waterborne coatings
  - Zinc rich primers and paints
  - Coal tar epoxies
  - High solids epoxies and urethanes
  - Plural component enamels and polyurethanes
- And many others*

### TYPICAL APPLICATIONS

- Corrosion protection
- Steel fabrications and structures
- Pipe and storage tank
- Marine and ship building
- Off road vehicles
- Truck, bus, trailer, railcar, and chassis manufacturers

#### BINKS MX SERIES FEATURES

##### Long Lasting Ceramic Coated Piston Rods

- Resists wear from highly abrasive fluids and lasts up to 3X longer than hard chrome

##### Extended Packing Life

- Spring loaded fixed packings last up to 3X longer than the competition

##### Low/No Ice

- Operate 2.5X longer than the competition

##### Patented Air Valve Technology

- Enables pump to change over quickly without pulsing

##### Lubricant Free Air Motor and Valve Design

- Reduces Maintenance and simplifies operation

##### 5 Year Limited Warranty

##### Low Noise

- <78 dBA at 80 psi air inlet pressure

##### Carbon or Stainless Steel Construction



#### BINKS 5-YEAR WARRANTY

Binks® warrants to the original end-use purchaser that Binks branded products shall not fail under normal use and service due to a defect in material or workmanship within five (5) years from the date of shipment from Binks. Does not include normal wear and tear parts.

## Air Assisted & Airless Outfits

### Air Assisted Airless Outfits:

Include: MX3536PU cart mounted pump, Air assist airless air control, air hose, fluid hose, and AA4400 gun.

98-3230 MX3536 Air Assist Airless outfit with 1-gun set up

98-3231 MX3536 Air Assist Airless outfit with 2-gun set up

### BINKS MX SERIES PERFORMANCE DATA

Binks MX Series Pump	MX3536	MX3042	MX3560	MX3070
Ratio	36:1	42:1	60:1	70:1
Max. Inlet Pressure	116 psi [8 bar]	101.5 psi [7 bar]	116 psi [8 bar]	101.5 psi [7 bar]
Flow Rate @ 15 cycles (continuous)	.875 gpm [3.31 l/m]	.75 gpm [2.84 l/m]	.875 gpm [3.31 l/m]	.75 gpm [2.84 l/m]
Flow Rate @ 60 cycles (continuous)	3.5 gpm [13.2 l/m]	3.0 gpm [11.4 l/m]	3.5 gpm [13.2 l/m]	3.0 gpm [11.4 l/m]
Volume cycle	7.4 oz [220 CC]	6.4 oz [190 CC]	7.4 oz [220 CC]	6.4 oz [190 CC]
Max Fluid Pressure	4,176 psi [288 bar]	4,263 psi [294 bar]	6,960 psi [480 bar]	7,105 psi [490 bar]
Cylinder Diameter	7.87 in [200mm]	7.87 in [200mm]	10 in [260 mm]	10 in [260 mm]
Piston Stroke	5 in [127mm]	5 in [127mm]	5 in [127mm]	5 in [127mm]
Noise Level	NA	NA	80 dB(a)*	80 dB(a)*
Operation Manuals	77-2963	77-2963	77-2960	77-2960

### BINKS MX ACCESSORIES & SPARES

#### Spray Guns

0811-7500-1	Airless 75 Gun with Stainless Steel Fluid Tube
0811-7500-2	Airless 75 Gun Direct Connect
0811-7500-3	Airless 75 Gun Direct Connect large passage
0811-7500-4	Airless 75 M Mastic Spray Gun

#### Accessories

192509	Silencer
72-2332	Binks Micro-Swivel 1/4" nps (F) to 1/4" nps (M) (7,550 psi)
72-2333	Binks Micro-Swivel 1/4" nps (F) to 3/8" nps (M) (7,550 psi)

#### Hose Assemblies

71-4860	8,000 psi 3/8 ID X 3/8 nps (F) X 25 ft
71-4861	8,000 psi 3/8 ID X 3/8 nps (F) X 25 ft
71-4782	Whip end 10,000 psi 1/4 ID X 1/4 nps (F) 3/8 npt (M) X 5 FT

#### Siphon

41-28270-5	5-Gallon Siphon
41-28270-55	55-gallon Siphon

#### Mountings

41-28280-200	Cart Assembly MX3536 and MX3042
41-28280-MX	Cart Assembly MX3560 and MX3570
104116	Wall Bracket Assembly

#### Filter

41-28275	Filter Assembly
0114-014917	30 Mesh
0114-014886	50 Mesh
0114-014884	70 Mesh
0114-014883	100 Mesh

### MX SERIES ORDERING INFORMATION

MX3560 60:1 pump carbon steel lower fluid section with PTFE/UHMW packings sold with a 100 mesh filter, 5-gal siphon kit, Airless 7500 gun no tip, 50' airless hose with 5' whip hose.

\*Specify tip separately when ordering

A	B	C	D	E	F	G	H
---	---	---	---	---	---	---	---

**MX 35 60 PU- C A C 1 S 3 5**

#### A OUTPUT

30	= 3.0 GPM
35	= 3.5 GPM

#### B RATIO

36	= 36:1
42	= 42:1
60	= 60:1
70	= 70:1

#### C MATERIAL

C	= Carbon Steel
S	= Stainless Steel

#### D MOUNTING

C	= Cart
W	= Wall

#### E FILTER

1	= 100 Mesh
3	= 30 Mesh
5	= 50 Mesh
7	= 70 Mesh

#### F SIPHON

0	= None
S	= 5 Gallon
T	= 55 Gallon

#### G GUN

0	= No Gun
3	= Airless 75 0811-7500-3

#### H HOSE

0	= None
2	= 25 Feet
5	= 50 Feet

Air Assist Airless

# Binks MX Heavy Duty Series Medium Pressure

## Air Assisted Airless Spray Outfits



Binks MX Pumps are a completely new design in air operated pump technology utilizing a patented magnetic detents to provide fast changeover with virtually no pulsation. The result is paint delivery with less pulsation for a more consistent finish.

The MX pistons are Ceramic coated which is the most durable surface available for resisting wear to high abrasive products. The MX medium pressure pumps are available in ratios of 11:1, 23:1, and 36:1 with outputs of 3.5 gpm

### RECOMMENDED MATERIALS

- Solvent coatings
- Waterborne coatings
- High solids
- Lacquers
- Enamels
- Urethanes

*And many others*

### TYPICAL APPLICATIONS

- Woodworking
- Aerospace
- Agricultural and off road vehicles
- Marine and ship building
- Truck and bus manufacturers

#### BINKS MX SERIES FEATURES

##### Long Lasting Ceramic Coated Piston Rods

- Resists wear from highly abrasive fluids and lasts up to 3X longer than hard chrome

##### Extended Packing Life

- Spring loaded fixed packings last up to 3X longer than the competition

##### Low/No Ice

- Operate 2.5X longer than the competition

##### Patented Air Valve Technology

- Enables pump to change over quickly without pulsing

##### Lubricant Free Air Motor and Valve Design

- Reduces Maintenance and simplifies operation

##### 5 Year Limited Warranty

##### Low Noise

- <78 dBA at 80 psi air inlet pressure

##### Carbon or Stainless Steel Construction



#### BINKS 5-YEAR WARRANTY

Binks® warrants to the original end-use purchaser that Binks branded products shall not fail under normal use and service due to a defect in material or workmanship within five (5) years from the date of shipment from Binks. Does not include normal wear and tear parts.



Air Assist Airless

## PUMP SPECIFICATIONS

BINKS MX ACCESSORIES AND SPARES	MX3511	MX3523	MX3536
AA1600 Flat Tip Gun Assembly (1310 tip)		0909-1600-HF1310	
AA1600 Twist Tip Gun Assembly (613 tip)		0909-1600-HT0613	
AA4400 Flat Tip Gun Assembly		0909-4400-HF0000	
Cart Assembly	41-28340	41-28340	41-28341
Wall Bracket Assembly	41-28334	41-28334	41-283345
Silencer	192821	192821	192509

HIGH PRESSURE FILTER ELEMENTS	
30 Mesh	0114-014917 (Blue)
50 Mesh	0114-014886 (Orange)
70 Mesh	0114-014884 (Yellow)
100 Mesh	0114-014883 (Black)

AIR MOTOR SPARES KIT			
Seal Kit	250729	250721	250703
Repair Kit	250728	250731	250702
Hardware Kit	250730	250730	250701
Air Motor Spares Kit	0115-010226	0115-010226	250649

FLUID SECTION REPAIR KIT	
Fluid Section Rebuild Kit	250661
Fluid Section Seal Kit	250659

## MX SERIES ORDERING INFORMATION

MX3511 11:1 pump stainless steel lower fluid section with PTFE/UHMW packings, cart mount sold with a 100 mesh filter, 5-gal siphon kit, AA1600 flat tip gun, and 25' of fluid and air hose.

**A B C D E F G H**

**MX 35 11 PU- S A C 1 S 6 2**

### A OUTPUT

35 = 3.5 GPM

### B RATIO

11 = 11:1  
23 = 23:1  
36 = 36:1

### C MATERIAL

S = Stainless Steel

### D MOUNTING

C = Cart  
W = Wall

### E FILTER

1 = 100 Mesh  
3 = 30 Mesh  
5 = 50 Mesh  
7 = 70 Mesh

### F SIPHON

0 = None  
S = 5 Gallon  
T = 55 Gallon

### G GUN

0 = No Gun

2 = AA4400 (Flat Tip)  
0909-4400-HF0000

3 = AA4400 (Twist Tip)  
0909-4400-HT0000

6 = AA1600 (Flat Tip)  
0909-1600-HF-1310

7 = AA1600 (Twist Tip)  
0909-1600-HT0613

### H HOSE

0 = None  
2 = 25 Feet  
5 = 50 Feet

*MX HD pumps are designed to operate at longer intervals in between repairs and reduce the overall cost of ownership*



# Binks Ram Unit Packages

## Sealant and Adhesive Supply pumps



Binks new range of Ram Units offer a reliable and higher performance solution for the delivery of medium and high viscosity materials. They deliver a constant, low pulse flow of materials to the dispensing tool by ensuring correct priming of the pump and preventing material cavitation.

Complete Ram Units include an easy-use pneumatic control box with up/down switch, auto shut off when the container is empty and a release valve to break the suction seal when lifting the ram plate clear of the used material. Optional extras include an automatic Change Over switch for use with two Ram Units.

### RECOMMENDED MATERIALS

- Lubricants
- Mastics
- Adhesives
- Epoxies
- Sealants

#### RAM PUMP FEATURES

##### Wide Choice of Pump Options

- Ratios from 8:1 to 60:1 (ball-check) and 5:1 to 68:1 for (chop-check)

##### Long Lasted Ceramic coated Piston Rods and Packings

- Resists wear and last up to 3X longer than the competition

##### Lubricant Free Air Motor and Valve Design

- Reduces Maintenance and simplifies operation

##### 5 Year Limited Warranty

- Stainless Steel pump fluid section as standard



#### BINKS 5-YEAR WARRANTY

Binks® warrants to the original end-use purchaser that Binks branded products shall not fail under normal use and service due to a defect in material or workmanship within five (5) years from the date of shipment from Binks. Does not include normal wear and tear parts.

## High Viscosity Supply Pumps

SR20	DR20	DR30	DR60	DR205	DRX205
<b>Single Post Ram Unit with 3" pneumatic rams and 20L / 5 US Gallon Follower Plate.</b>	<b>Dual Post Ram Unit with 3" pneumatic rams and 20L / 5 US Gallon Follower Plate.</b>	<b>Dual Post Ram Unit with 3" pneumatic rams and 30L / 7.5 US Gallon Follower Plate.</b>	<b>Dual Post Ram Unit with 3" pneumatic rams and 60L / 15 US Gallon Follower Plate.</b>	<b>Dual Post Ram Unit with 3" pneumatic rams and 205L / 55 US Gallon Follower Plate.</b>	<b>Dual Post Extreme Duty Ram Unit with 6" pneumatic rams and 205L / 55 / 60L / 15 US Gallon Follower Plate.</b>
6 pump options. <i>Cart mounted version available.</i>	13 pump options.	13 pump options.	13 pump options.	24 pump options.	24 pump options.

### Ram Unit Pump Outfit Options

Equip your Ram Unit from our extensive range of durable, hard-working MX Pumps.

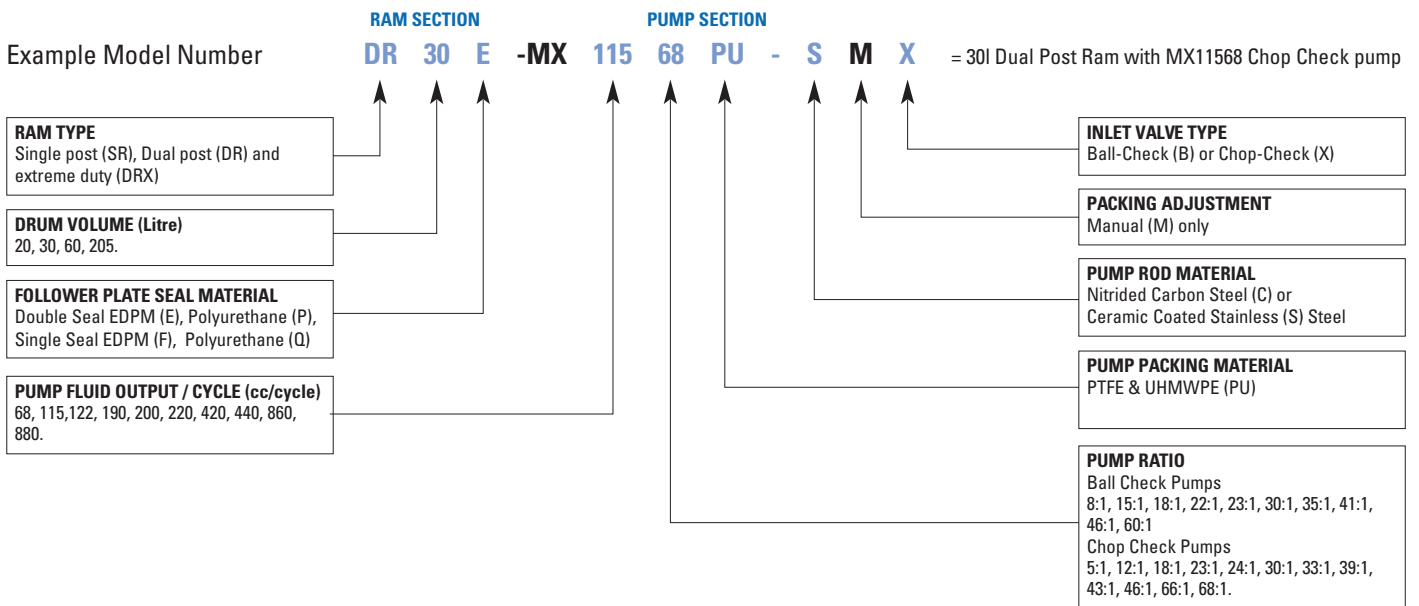

PUMP FEATURE		
Maximum Working Air Pressure		6 Bar / 87 psi
Air Inlet	SR20	410 mm / 16"
	DR20/30/60	688 mm / 27"
Ram Stroke	DR205	960 mm / 37.8"
	DRX205	1242 mm / 49"
	DR20/30/60	1750 mm / 69"
Unit Height - Fully Extended	DR205	2550 mm / 100"
	DRX205	

PUMP FEATURE		
Wiper Ring Material	SR20	EPDM / PU
	DR20/30/60	
	DR205	EDPM
	DRX205	
Weight without Pump	SR20	55 kg / 121 lbs
	DR20/30/60	130 kg / 286 lbs
	DR205	212 kg / 466 lbs
	DRX205	

# Binks Maple Pump

## Low Pressure & Medium Pressure Models

HORIZONTAL PUMPS FOR CIRCULATION & SPRAY GUN FEED APPLICATIONS

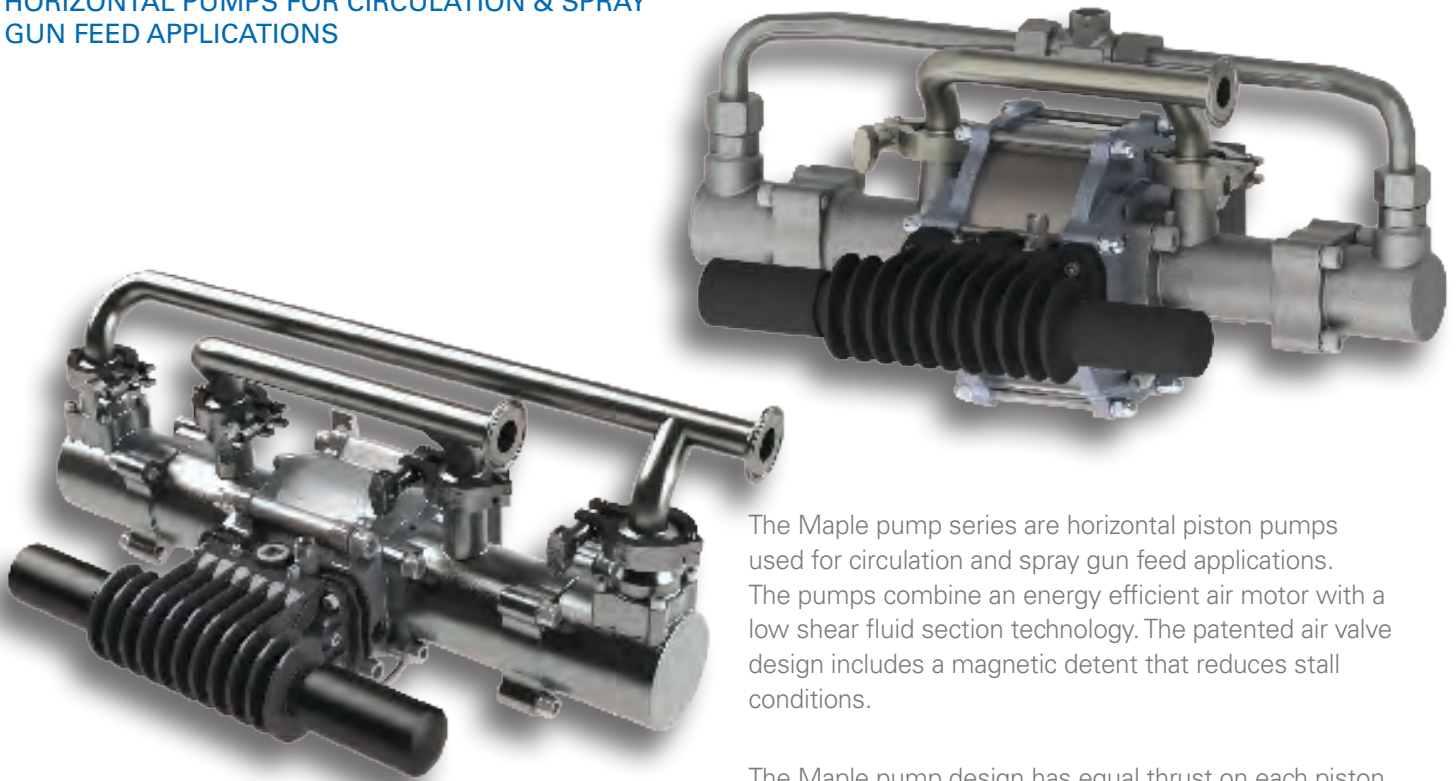

*Binks Maple are the Finishing Industry's best pump solution for circulation systems and among the Top Choice for Automotive OEM customers.*

**Reduction in Energy costs**

- Efficient design reduces air consumption

**Reliable Operation**

- Backup seal ensures continued operation of pump until next shift

**Patented Air Valve Technology**

- Allows pump to changeover quickly to significantly reduce pulsation

**Simple to Maintain**

- No "upper seal" to keep lubricated or adjusted

The Maple pump series are horizontal piston pumps used for circulation and spray gun feed applications. The pumps combine an energy efficient air motor with a low shear fluid section technology. The patented air valve design includes a magnetic detent that reduces stall conditions.

The Maple pump design has equal thrust on each piston stroke and quick pump change over reduces pressure fluctuations to a minimum.

**RECOMMENDED MATERIALS:**

- Waterborne
- High solids
- High Abrasives
- CARC
- UV Cured
- Solvent borne
- Catalyst

**TYPICAL APPLICATIONS:**

- Circulation Systems
- Spray gun applications
- Flatline machinery



**BINKS 5-YEAR WARRANTY**

Binks® warrants to the original end-use purchaser that Binks branded products shall not fail under normal use and service due to a defect in material or workmanship within five (5) years from the date of shipment from Binks. Does not include normal wear and tear parts.

## Horizontal Piston Pump



Maple 15



Maple 30



Maple 60



Maple 20 AFP



Maple 7/15



Maple 8/25

Specifications	Maple 15	Maple 30	Maple 60	Maple 20 AFP*	Maple 7/15	Maple 8/25
Part #	104009-N	104010-N	104020	104016	104041-N	104042-N
Weight	46 lbs (21 kg)	66 lbs (30 kg)	145 lbs (66 kg)	77 lbs (35 kg)	57 lbs (26 kg)	88 lbs (40 kg)
Ratio	3:1	3:1	3:1	4.2:1	15:1	25:1
Flow @ 60 Cycles/Min	6 gal (23 liters)	12 gal (45 liters)	24 gal (91 liters)	6.8 gal (26 liters)	2.6 gal (10 liters)	3.2 gal (12 liters)
Displacement/Cycle	375 cc/0.1 gal	750 cc/0.2 gal	1,500 cc/0.4 gal	475 cc/0.125 gal	166 cc/0.044 gal	200 cc/.053 gal
Inlet Fluid Connection	1" Sanitary	1 1/2" Sanitary	1 1/2" Sanitary	1" Sanitary	1" Sanitary	1" Sanitary
Outlet Fluid Connection	1" Sanitary	1 1/2" Sanitary	1 1/2" Sanitary	3/4" Sanitary	1/2" NPT Female	1/2" NPT Female
Air Connection Wetted Materials	3/8 nps (m)/bsp (m)	3/8 nps (m)/bsp (m)	3/8 nps (m)/bsp (m)	3/8 nps (m)/bsp (m)	3/8 nps (m)/bsp (m)	3/8 nps (m)/bsp (m)
Max Fluid Pressure	300 psi (21 bar)	300 psi (21 bar)	300 psi (21 bar)	420 psi (29 bar)	1,575 psi (109 bar)	2,625 psi (181 bar)
Air Consumption @ 45 psi	0.17 scfm/cycle	0.33 scfm/cycle	0.75 scfm/cycle	0.33 scfm/cycle	0.33 scfm/cycle	0.7 scfm/cycle
Max Air Inlet Pressure	100 psi (6.9 bar)	100 psi (6.9 bar)	100 psi (6.9 bar)	100 psi (6.9 bar)	100 psi (6.9 bar)	100 psi (6.9 bar)
Max Recommended Continuous Cycle Rate	20 cpm	20 cpm	20 cpm	20 cpm	20 cpm	20 cpm
Instruction Manual Part #	104009	104010	104020	104016	104041	104042

\*For use with piggable systems with push and solvent air chop.

PART NO.	ACCESSORIES
<b>Filters</b>	
41-28283	100 Mesh Filter Kit Top Mount
41-28284	100 Mesh Filter Kit Rear Mount
<b>Surge Chambers</b>	
104050P-B-B	2" Sanitary Active Surge Eliminator
104050P-C-C	1 1/2" Sanitary Active Surge Eliminator
104050P-D-D	1 1/2" npt (Female) Active Surge Eliminator
104050P-L-L	1" Sanitary Active Surge Eliminator
104053-C-C	1 1/2" Sanitary Surge Chamber
104053-D-D	1 1/2" npt (Female) Surge Chamber
104053-L-L	1" Sanitary Surge Chamber

PART NO.	ACCESSORIES
107757	Low Shear Back Pressure Regulator, 3/4" Ports, Stainless Steel, No Gauge
<b>Connection Kits for Pumps:</b>	
502716	1 1/2" Sanitary x 1" npt (F) (2 Sets of Parts)
502717	1" Sanitary x 3/4" npt (F) (2 Sets of Parts)
502744	1" Sanitary x 3/4" npt (F) (1 Set of Parts)
502745	1 1/2" Sanitary x 1" npt (F) (1 Set of Parts)
41-28282	1" Sanitary x 1" npt (F) (1 Set of Parts)

MAPLE PUMP REPAIR KITS	15	30	60	20AFP	7/15	8/25
Fluid Piston Seal Kit	250625	250608		41-4456		
Fluid Section Overhaul Kit	250626	250619	250633		250655	250654
Air Motor Seal Kit	250627	250618	250666	250618	250657	250656
Control Valve Kit	250628	250620		250620		

# Binks Series Smart Pumps



Binks Smart Pumps are respected for their energy saving capabilities and proven reliability. This is why they are found in the world's largest Automotive OEM and Tier 1 paint shops.

The Binks series Smart Pumps use standard electric motors to drive the fluid section for pumping paints, solvents and other suitable materials. Smart pumps are available in different models with flow rates from 1 gpm-16 gpm and pressure up to 290 psi.

Smart pumps achieves a reciprocating drive by using a cam and cam followers combined with a sliding carriage unit. Equal thrust on each stroke together with the special cam profile reduces fluid pressure fluctuations to an absolute minimum.

The Smart Pump has the available Smart Card that provides higher energy savings and lower operational cost by running in an open or closed loop mode which delivers paint to the use point at the correct pressure and volume only when needed. Operational costs are much lower than compressed air driven models.

## Pulsation Free Operation

- Constant velocity Cam provides equal pressure on both pistons

## Smart Pump delivers constant flow control

- Motor Hz is directly related to material flow rate

## Reduced Energy Costs

- Smart Circulation system significantly reduces energy usage and paint shear

## No exterior leaking seal

- Backup seal ensures continued operation of pump until the next shift

## RECOMMENDED MATERIALS

- Waterborne
- Solvent borne
- High Solids
- Moisture Sensitive Materials

## TYPICAL APPLICATIONS

- Circulation systems



## BINKS 5-YEAR WARRANTY

Binks® warrants to the original end-use purchaser that Binks branded products shall not fail under normal use and service due to a defect in material or workmanship within five (5) years from the date of shipment from Binks. Does not include normal wear and tear parts.

## Electric Circulation Pumps

	E2-15	E2-30	E2-40	E2-60	E4-60
<b>PART NO.</b>	104018	107074	107094	104086-311	107073
Weight	172 lbs (78 kg)	550 lbs (250 kg)	550 lbs (250 kg)	650 lbs (295 kg)	793 lbs (360 kg)
Number of Pistons	2	2	2	2	4
Max Flow 40 Cycles	4 gpm (15 L)	8 gpm (30 L)	10.6 gpm (40 L)	16 gpm (60 L)	16 gpm (60 L)
Flow/Cycle	0.13 gal (0.5 L)	0.2 gal (0.75 L)	0.26 gal (1.0 L)	0.4 gal (1.5 L)	0.4 gal (1.5 L)
Max Fluid Pressure	290 psi	290 psi	230 psi	290 psi	290 psi
Electric Motor	1 HP	2 HP	2 HP	5 HP	5 HP
Fluid Connection	1" Sanitary	1.5" Sanitary	1.5" Sanitary	1.5" Sanitary	2" Sanitary
<b>Repair Kits</b>					
Fluid Piston Seal Kit	250625	250608	250621	250601	250601
Wet Section Overhaul Kit	250641	250610	250622	250595	250595
Main Bearing Overhaul Kit	250642	250599	250599	250599	250599

ACCESSORIES	PART NO.
Air Piloted Back Pressure Regulator 1.5"	107755
Air Piloted Back Pressure Regulator 3/4"	107758
Pressure Relief Valve	PRV22

### Back Pressure Regulator

The Binks low shear back pressure regulators adjust to control the paint system back pressure within the pipe line and minimizes paint shear due to the large surface area of the valve seating. When the paint flow fluctuates the air pressure acting on the diaphragm automatically increases or decreases the forces acting on the paint flow, thus maintaining the set paint system pressure level.

# Low Pressure Fluid Regulators



Part Number	Wetted Parts	Inlet/Outlet	Inlet Pressure Min. (psi/bar)	Inlet Pressure Max. (psi/bar)	Outlet Pressure Min. (psi/bar)	Outlet Pressure Max (psi/bar)	Capacity (gpm/lpm)
84-120	Nickel Plated Brass	3/8"npt (m) 3/8"nps(m)	n/a	100/7	5/0.35	40/2.7	1/3.8



Part Number	Wetted Parts	Inlet/Outlet	Inlet Pressure Min. (psi/bar)	Inlet Pressure Max. (psi/bar)	Outlet Pressure Min. (psi/bar)	Outlet Pressure Max (psi/bar)	Capacity (gpm/lpm)
HGB-502-1	SST	3/8"npt (f) 3/8"nps(f) (2)	50/3.5	175/12	10/0.7	75/5	8/30
HGB-508-1	SST	3/8"npt (f) 3/8"nps(m)-3/8"npt (f)	50/3.5	175/12	10/0.7	75/5	8/30
HGB-509-5-R38	SST	3/8"bsp(f) 3/8"nps-bsp (m)	30/2	180/12.5		75/5	3.4/13
HGB-609-1.2-R38	SST	3/8"bsp(f) 3/8"nps-bsp (m)	15/1	115/8		35/2.5	2.2/8.3
HGB-609-5-R38	SST	3/8"bsp(f) 3/8"nps-bsp (m)	30/2	175/12		75/5	3.4/13
HGB-609-9-R38	SST	3/8"bsp(f) 3/8"nps-bsp (m)	45/3	215/15		130/9	3.4/13

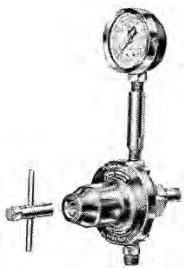

Part Number	Wetted Parts	Inlet/Outlet	Inlet Pressure Min. (psi/bar)	Inlet Pressure Max. (psi/bar)	Outlet Pressure Min. (psi/bar)	Outlet Pressure Max (psi/bar)	Capacity (gpm/lpm)
84-410	SST	3/8" npt (f) 3/8"nps(m)-3/8"npt (f)		100/7	1/0.1	12/1	0.1/0.4
84-320	SST	3/8"npt (m) 3/8"nps(m)		200/14	5/0.3	55/4	1/3.8
84-407	SST	3/8"npt (f) 3/8"nps(m)		200/14	5/0.3	55/4	1/3.8
84-409	SST	3/8"npt(m) 3/8"nps(m)-3/8"npt (f)		200/14	5/0.3	100/7	1/3.8
84-346	Zinc Plated	3/8"npt(m) 3/8"nps(m)-1/4"npt (f)		100/7	1/0.1	12/1	0.1/0.4
84-345	Zinc Plated	3/8"npt (m) 3/8"nps(m)		200/14	5/0.3	55/4	1/3.8
84-411	Zinc Plated	3/8"npt (m) 3/8"nps(m)		200/14	5/0.3	100/7	1/3.8
84-412	Zinc Plated	3/8"npt (m) 3/8"nps(m)		200/14	5/0.3	100/7	1/3.8



## Low Pressure Fluid Regulator

# Air Pilot

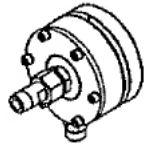

Part Number	Wetted Parts	Inlet/Outlet	Inlet Pressure Min. (psi/bar)	Inlet Pressure Max. (psi/bar)	Outlet Pressure Min. (psi/bar)	Outlet Pressure Max (psi/bar)	Capacity (gpm/lpm)
84-598	Chrome Plated Aluminum	3/8"npt (m) 3/8"nps(m)		200/14	4/0.25	100/7	0.23/1



Part Number	Wetted Parts	Inlet/Outlet	Inlet Pressure Min. (psi/bar)	Inlet Pressure Max. (psi/bar)	Outlet Pressure Min. (psi/bar)	Outlet Pressure Max (psi/bar)	Capacity (gpm/lpm)
HGB-510-R1	SST	1/4"bsp (f) 1/4"bsp(f)	30/2	220/15		220/15	.42/1.6
HGB-510-R2	SST	1/4"bsp (f) 1/4"bsp(f)	15/1	220/15		100/7	.35/1.3
HGB-510-R4	SST	1/4"bsp (f) 1/4"bsp(f)	15/1	220/15		60/4	.2/8
HGB-510-R1-CO	SST	3/8"nps-bsp (m)/ 1/4"bsp (f)	30/2	220/15		220/15	.42/1.6
HGB-510-R2-CO	SST	3/8"nps-bsp (m)/ 1/4"bsp (f)	15/1	220/15		100/7	.35/1.3
HGB-510-R4-CO	SST	3/8"nps-bsp (m)/ 1/4"bsp (f)	15/1	220/15		60/4	.2/8



Part Number	Wetted Parts	Inlet/Outlet	Inlet Pressure Min. (psi/bar)	Inlet Pressure Max. (psi/bar)	Outlet Pressure Min. (psi/bar)	Outlet Pressure Max (psi/bar)	Capacity (gpm/lpm)
845020	SST/Tungsten Carbide	1/4"npt (f) (2) 1/4"npt(f)		750/52		30/2	3/11.5



Part Number	Wetted Parts	Inlet/Outlet	Inlet Pressure Min. (psi/bar)	Inlet Pressure Max. (psi/bar)	Outlet Pressure Min. (psi/bar)	Outlet Pressure Max (psi/bar)	Capacity (gpm/lpm)
845004	SST/Tungsten Carbide	3/8"npt (f) 3/8"nps(f)		750/52	20/1.4	60/4	6/23

Medium, High & Back Pressure

## Medium Pressure Fluid Regulators



Part Number	Wetted Parts	Inlet/Outlet	Inlet Pressure Min. (psi/bar)	Inlet Pressure Max. (psi/bar)	Outlet Pressure Min. (psi/bar)	Outlet Pressure Max (psi/bar)	Capacity (gpm/lpm)
845001	SST/Tungsten Carbide	3/8"npt (f) 3/8"nps(f)		1250/86	100/7	800/55	6/23

## High Pressure Fluid Regulators



Part Number	Wetted Parts	Inlet/Outlet	Inlet Pressure Min. (psi/bar)	Inlet Pressure Max. (psi/bar)	Outlet Pressure Min. (psi/bar)	Outlet Pressure Max (psi/bar)	Capacity (gpm/lpm)
845014	carbon steel/ Tungsten carbide	3/8"npt (f) 3/8"npt(f)		3000/207	400/28	1250/86	3/11.5
845011	SST/Tungsten Carbide	3/8"npt (f) 3/8"npt(f)		6000/414	1000/70	3000/27	3/11.5
845013	SST/Tungsten Carbide	3/8"npt (f) 3/8"npt(f)		6000/414	2000/140	5000/345	6/23
845010	SST/Tungsten Carbide	3/8"npt (f) 3/8"npt(f)		3000/207	400/28	1250/86	3/11.5
84-420	SST	1/4"npt (m) 1/4"npt(f)		3000/207	300/21	2000/139	1/3.8
84-520	SST	1/4"npt (m) 1/4"npt(f)		2000/14	100/7	900/62	1/3.8

## Back Pressure Fluid Regulators - Low Pressure



Part Number	Wetted Parts	Inlet/Outlet	Inlet Pressure Min. (psi/bar)	Inlet Pressure Max. (psi/bar)	Outlet Pressure Min. (psi/bar)	Outlet Pressure Max (psi/bar)	Capacity (gpm/lpm)
84-501	Electroless nickel plated	1/2"npt (f) 1/2"npt(f)		150/10	10/0.7	140/10	7/26
84-404	SST	3/4"npt (f) 3/4"npt(f)		150/10	10/0.07	140/10	11/42
84-601	SST (low shear)	1/2"npt (f) 1/2"npt(f)		200/14	0/0	130/9	1/3.8
845000	SST	3/8"npt (f) 3/8"npt(f)		200/14	0/0	220/14	6/23
845003	SST	1-1/4"npt (f) 1/4"npt(f)		200/14	0/0	200/14	18.5/70
HGBR-609	SST	1/4"npt (f) 1/4"npt(f)	30/2	180/12.5	0/0	130/9	4.9/18

Back Pressure

## Back Pressure Regulators - Medium Pressure

Part Number	Wetted Parts	Inlet/Outlet	Inlet Pressure Min. (psi/bar)	Inlet Pressure Max. (psi/bar)	Outlet Pressure Min. (psi/bar)	Outlet Pressure Max (psi/bar)	Capacity (gpm/lpm)
845002	SST	3/8"npt (f) 3/8"npt(f)		800/55	0/0	800/55	6/23



## Back Pressure Regulators - High Pressure

Part Number	Wetted Parts	Inlet/Outlet	Inlet Pressure Min. (psi/bar)	Inlet Pressure Max. (psi/bar)	Outlet Pressure Min. (psi/bar)	Outlet Pressure Max (psi/bar)	Capacity (gpm/lpm)
84-421	SST	1/4"npt (m)		3000/207	100/7	2000/140	1/3.8



845012	SST	3/8"npt (f) 3/8"npt(f)		3000/207	100/7	3000/207	6/23
--------	-----	------------------------	--	----------	-------	----------	------



## BPR 1 1/2" Air Piloted & Manual Low Paint Shear

- Low shear paint system regulation
- Reduced paint velocity through valve seat
- 0-218 psi (0-15 Bar) regulated pressure control
- Two gauge ports to provide best mounting orientation
- Stainless Steel fluid body
- 107755-Air Pilot 107754 manual



## BPR 3/4" Air Piloted & Manual Low Paint Shear

- Low shear system regulation
- 0-218 psi (0-15 Bar) regulated pressure control
- 107758 air piloted, 107757 manual



## Surge Eliminator Active Flushable

- Self-compensating design eliminating manual charging with compressed air
- Active feature dynamically changes air pressure automatically to equal fluid pressure
- Elimination of paint surge due to pressure fluctuation
- Increased air volume for improved damping
- Flushable fluid chamber
- Fluid connections options available
- Max fluid pressure 232 psi (16 bar)
- Fluid chamber is 316 SST and diaphragm is PTFE

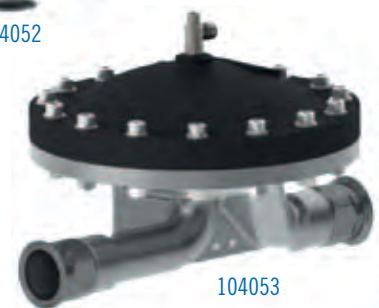

## Surge Eliminator: Standard & Standard Flushable

- Low maintenance only periodic charging with compressed air
- Flushable fluid chamber
- Fluid chamber is 316 SST and diaphragm is PTFE
- 104052 Standard, 104053 Flushable

Direct Drive, Gear Drive, Mixers

## QMG-416 Direct Drive Agitator For Use With 183G Galvanized Tanks

## QMS-430 Direct Drive Agitator For Use with 183S Stainless Steel Tanks

- Agitators for 2 Gallon Pressure Tanks
- Air-powered with direct drive agitator assembly with ¼ HP air motor and a three-bladed propeller to keep materials mixed in suspension
- Agitator assemblies come complete with HAV-500 air adjusting valve and HAV-57011 air hose assembly



QMG-416

## QS-5012-1 Indirect Agitator Air Motor Drive

- For 2 gal, 5 gal, 10 gal and 15 gal 183G, 183S, QMGT, QMST tanks only
- Standard duty smooth running with gear reducer
- 1/2HP 20:1 ratio 150 RPM maximum
- Included throttling valve, fittings, and hose for connection to air supply on tank lid



QS-5012-1

## 31-396-1 Agitator Drive

- For use on 30, 60 gallon pressure tanks and 55 gallon drums
- 20:1 ratio, ½ HP, 150 PRM maximum
- HAV-500 adjusts the speed of the air motor
- Air consumption approximately 30 CFM@100 psi

Direct Drive, Gear Drive, Mixers

## 5 & 55 Gallon Direct & Indirect Agitators

### 5-GALLON PAIL AGITATORS

PART NO.	DESCRIPTION	CONTAINER SIZE	HP	NUMBER OF PROPELLERS
31-3133	Direct Drive with cover sst propeller	5 gal	1/4	1
41-3312	Direct Drive without cover sst propeller	5 gal	1/4	1
41-3306	Direct Drive without cover Alum. Propeller	5 gal	1/4	1

### AGITATORS FOR LIGHT BODY MATERIALS

PART NO.	DESCRIPTION	CONTAINER SIZE	HP	NUMBER OF PROPELLERS
41-3300	Direct Drive without cover, alum. Propeller	55 gallon	3/4	1
41-3304	Direct Drive without cover, sst. Propeller	55 gallon	3/4	1
31-129	Direct Drive with cover, sst. Propeller	55 gallon	3/4	1

### GEAR DRIVE AGITATORS FOR HEAVY FLUIDS

PART NO.	DESCRIPTION	CONTAINER SIZE	HP	NUMBER OF PROPELLERS
31-397	Gear Drive with 31-124 cover	55 gallon	1/2	2
202-55-2	Gear Drive	55 gallon	1 1/2	2
202-55-4	Gear Drive	55 gallon	1 1/2	4
31-394	For use with drum with built-in agitator 20:1 ratio	55 gallon	1/2	
31-400	For use with 55-gal open-top drums	55 gallon	1	
31-296	Heavy Duty Bung Agitator	55 gallon	1	2

### COVERS

- 41-3205
  - 5-gallon Cover
  - Used for open-top container
- 31-124
  - 55-gallon drum cover

### Stainless Steel Bunghole Adapter Kits

41-15899	Bunghole adapter for 1/2" pipe
41-15898	Bunghole adapter for 3/4" pipe
41-15895	Bunghole adapter for 1" pipe



Direct Drive, Gear Drive, Mixers

# 41-9000 Drum Elevator

- Single post elevator for lifting 55 gallon cover-mounted pump and agitator units
- Can support up to 375 lbs.
- Induced air control valve, 10 ft. of air tubings, mounting brackets and hardware

41-9000



## Binks Quick-Mixers For Container Sizes of 5 to 55 Gallons

Designed for standard and for extra heavy industrial uses

**All Purpose:** Unsurpassed for paint, resins, chemicals, and slurries.

**High Performance:** Explosion-proof direct drive air motors: 1/2 HP (standard). Implosion-type high shear mixer blades thoroughly mix 5 gallons of paint in less than 60 seconds.

**Rugged:** Stainless steel shaft and impeller. Specially welded stress points makes mixer virtually unbreakable.

**Puncture-Proof:** Patented double ring design eliminates damage to container.

**Speed:** The speed of the air motor is regulated by an air adjusting valve (73-159).



## QS-5003-1 Paint Drum Agitator Drive

- For use with paint drums having built-in agitators
- Powerful 1/2 HP Variable speed air motor
- Requires 5 to 8 CFM of air for 50 RPM
- Includes couplings to fit 7/16 in. and 1/2 in. agitator shafts
- Mounting adapter fits both 1-1/2 in and 2 in. threads



QS-5003-1

MODEL NO.	MODEL NO. (Stainless Steel)	CONTAINER	LENGTH x DIA.	IMPELLER DIA.	SHAFT LENGTH	WEIGHT	REF. PART SHEET
149-873 (1/2 HP)	149-365	5 & 10 Gallons	21 in. x 1/2 in.	5 in.	21 in	9 lbs.	77-2826
149-874 (1/2 HP)	149-693	55 Gallons	40 in. x 1/2 in.	5 in.	40 in.	10 lbs.	77-2826

## **Carlisle Fluid Technologies – Over 375 Years Of Combined Finishing Expertise.**

The story of advancement in application technology is the story of Carlisle Fluid Technologies brands – DeVilbiss, Ransburg, MS, BGK and Binks. Each brand grew into its' own and became leaders in their individual product categories. Today – and collectively – those products share more than a common heritage of performance excellence and dependability. They also share a common name.

Carlisle Fluid Technologies is a unique, integrated provider of total paint system solutions. Electrostatic and conventional guns, fluid handling equipment, fluid metering, powder coating, process controls, curing – everything is designed and manufactured for system integration and to provide customers with finishing solutions adding long term value.



### ***Sales and Service through our Global Network of Distributors***

Carlisle Fluid Technologies offices

Americas:           **USA** ▪ **Mexico** ▪ **Brazil**  
Europe:             **United Kingdom** ▪ **Germany**  
Asia/Pacific Rim: **China** ▪ **Japan** ▪ **India** ▪ **Australia**

**BINKS**<sup>®</sup>

[www.binks.com](http://www.binks.com)  
1.800.99.BINKS

[www.carlisleleft.com](http://www.carlisleleft.com)

