

Operating instructions and spare parts list

OptiFeed PP06(-E) powder pump

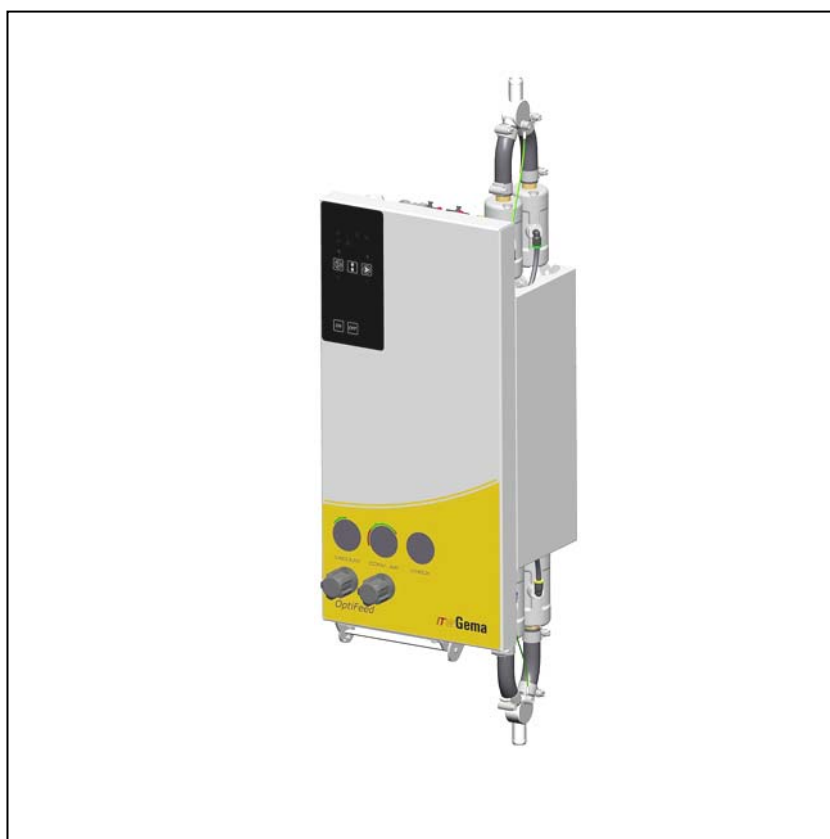

Translation of the original operating instructions

Documentation for OptiFeed PP06 powder pump

© Copyright 2006 Gema Switzerland GmbH

All rights reserved.

This publication is protected by copyright. Unauthorized copying is prohibited by law. No part of this publication may be reproduced, photocopied, translated, stored on a retrieval system or transmitted in any form or by any means for any purpose, neither as a whole nor partially, without the express written consent of Gema Switzerland GmbH.

Gema, EquiFlow, MagicCompact, MagicCylinder, OptiCenter, OptiFlex, OptiGun, OptiSelect and OptiStar are registered trademarks of Gema Switzerland GmbH.

ClassicLine, ClassicStandard, ClassicOpen, DVC (Digital Valve Control), GemaConnect, MagicControl, MagicPlus, MonoCyclone, MRS, MultiColor, MultiStar, OptiAir, OptiControl, OptiColor, OptiFeed, OptiFlow, OptiHopper, OptiMove, OptiSieve, OptiSpeeder, OptiSpray, PCC (Precise Charge Control), RobotGun, SIT (Smart Inline Technology) und SuperCorona are trademarks of Gema Switzerland GmbH.

All other product names are trademarks or registered trademarks of their respective holders.

Reference is made in this manual to different trademarks or registered trademarks. Such references do not mean that the manufacturers concerned approve of or are bound in any form by this manual. We have endeavored to retain the preferred spelling of the trademarks, and registered trademarks of the copyright holders.

To the best of our knowledge and belief, the information contained in this publication was correct and valid on the date of publication. Gema Switzerland GmbH makes no representations or warranties with respect to the contents or use of this publication, and reserves the right to revise this publication and make changes to its content without prior notice.

For the latest information about Gema products, visit www.gemapowdercoating.com.

For patent information, see www.gemapowdercoating.com/patents or www.gemapowdercoating.us/patents.

Printed in Switzerland

Gema Switzerland GmbH
Mövenstrasse 17
9015 St.Gallen
Switzerland

Phone: +41-71-313 83 00

Fax.: +41-71-313 83 83

E-mail: info@gema.eu.com

Table of contents

General safety regulations	5
Safety symbols (pictograms).....	5
Conformity of use.....	5
Product-specific safety measures.....	6
OptiFeed PP06 powder pump.....	6
About these operating instructions	7
General information.....	7
Software version.....	7
Product description	9
Field of application.....	9
OptiFeed PP06 powder pump.....	9
Utilization.....	10
Reasonably foreseeable misuse.....	10
Technical data.....	11
Powder output (guide values).....	11
Electrical data.....	11
Pneumatic data.....	11
Dimensions.....	12
Processible powders.....	12
Sound pressure level.....	12
Rating plate.....	13
Design and function.....	15
General view.....	15
Compressed air indicators.....	15
Operating elements.....	16
Connections.....	17
Internal design.....	19
Scope of delivery.....	19
Available accessories.....	19
Principle of operation.....	20
Suction procedure.....	20
Conveying procedure.....	20
Typical properties – functional characteristics.....	21
Conveying direction.....	21
Powder hose emptying/after-conveying.....	21
Powder hose rinsing.....	21
Level sensor signal delay.....	22
Maintenance interval monitoring.....	22
Timer function.....	22
Powder fluidization.....	23
Start-up	25
Preparation for start-up.....	25
Basic conditions.....	25
The basics (preparation).....	25

Set-up	26
Assembly guide	26
Connection possibilities	27
Connection via the Mains/PLC 2.1 connection.....	27
Connecting the external power supply unit	27
Connecting a level sensor	27
Connecting the OptiFeed PP06 powder pump.....	28
Initial start-up	29
Programming parameters	29
Conveying direction	29
Direction of powder hose rinsing	30
After-conveying.....	30
Setting the rinse program	31
Changing the rinse program	31
Level sensor delay.....	32
Timer function	32
Restoring default values	33
Manual operation	34
Switching on the PP06 powder pump	34
Manually starting the conveying procedure.....	34
Manually stopping the conveying procedure	34
Manually starting the rinse procedure	34
Manually reversing the rinse direction	34
Manually stopping the rinse procedure	35
Setting the suction and conveying parameters	35
Setting the suction vacuum (VACUUM)	35
Setting the conveying air (CONV. AIR)	35
Procedure monitoring (CHECK)	36
External control.....	37
Externally starting and stopping the conveying procedure.....	37
Externally switching the rinsing procedure on and off.....	37
External control with level sensor	37
External control – summary	38
Start-up	38
Decommissioning	38
Cleaning and maintenance	39
Maintenance of the powder pump	39
Daily maintenance	39
Weekly maintenance	39
OptiFeed PP06 Powder pump – maintenance plan	40
Maintenance according to maintenance interval monitoring	40
Resetting the maintenance interval	40
Maintenance set	40
Replacing the pinch valves.....	41
Replacing the filter elements	43
Corrective action	45
General information	45
Service functions	47
Powder hose emptying before powder supply	47
Timing diagram – Control/PLC 2.1 connection.....	47

Schematic diagrams	49
OptiFeed PP06 – block diagram	49
OptiFeed PP06 – pneumatic diagram.....	50
Spare parts list	51
Ordering spare parts	51
OptiFeed PP06 powder pump.....	52
OptiFeed PP06 powder pump.....	53
OptiFeed PP06 powder pump – pneumatic group.....	54
OptiFeed PP06 powder pump – pneumatic group.....	55
OptiFeed PP06 powder pump – powder chamber.....	56
OptiFeed PP06 powder pump – powder chamber.....	57

General safety regulations

This chapter sets out the fundamental safety regulations that must be followed by the user and third parties using the OptiFeed PP06 powder pump.

These safety regulations must be read and understood before the OptiFeed PP06 powder pump is put into operation.

Safety symbols (pictograms)

The following warnings with their meanings can be found in the Gema operating instructions. The general safety precautions must also be followed as well as the regulations in the relevant operating instructions.

**DANGER!**

danger due to live electricity or moving parts. Possible consequences: Death or serious injury

**WARNING!**

improper use of the equipment could damage the machine or cause it to malfunction. Possible consequences: minor injuries or damage to equipment

**INFORMATION!**

useful tips and other information

Conformity of use

1. In accordance with the current state of the art and recognized technical safety regulations, the OptiFeed PP06 is designed exclusively for use in standard powder coating applications.
2. Any other use is considered non-compliant. The manufacturer shall not be liable for damage resulting from such use; the user bears sole responsibility for such actions. If the OptiFeed PP06 powder pump is to be used for other purposes or other substances outside our specifications, Gema Switzerland GmbH must be consulted.
3. Observance of the operating, service and maintenance instructions specified by the manufacturer is also part of

conformity of use. The OptiFeed PP06 powder pump should only be used, maintained and started up by trained personnel who are informed of and are familiar with the possible hazards involved.

4. The machine must not be commissioned (i.e., normal operation should not commence) until it has been established that the OptiFeed PP06 powder pump has been set up and wired in accordance with the Machinery Directive (2006/42 EC).
5. EN 60204-1 (machine safety) must also be observed.
6. Unauthorized modifications to the OptiFeed PP06 powder pump exempt the manufacturer from any liability from resulting damage.
7. The relevant accident prevention regulations, as well as other generally recognized safety regulations, occupational health and structural regulations are to be observed.
8. Furthermore, the country-specific safety regulations also must be observed.

Explosion protection	Protection type	Temperature class
CE  II 3 D	IP54	T6

Product-specific safety measures

- Installation work performed by the customer must be carried out according to local regulations.
- All components must be grounded according to the local regulations before start-up.

OptiFeed PP06 powder pump

The OptiFeed PP06 powder pump is a constituent part of the equipment and is therefore integrated into the equipment safety system.

For the use outside of the safety concept, corresponding measures must be taken.



Note:

For further security information, see the detailed Gema safety regulations!

About these operating instructions

General information

This operating manual contains all the important information you will need to work with the OptiFeed PP06 powder pump. It will safely guide you through the start-up process and give you references and tips for the optimal use of your new powder coating system.

Information about the function mode of the individual system components – booth, gun control unit, gun or powder injector – can be found in the supplied documents.



DANGER:

Working without operating instructions

Working without operating instructions or with individual pages from the operating instructions may result in damage to property and personal injury if relevant safety information is not observed.

- ▶ Before working with the device, organize the required documents and read the section "Safety regulations".
 - ▶ Work should only be carried out in accordance with the instructions of the relevant documents.
 - ▶ Always work with the complete original document.
-

Software version

This document describes the operation of the OptiFeed PP06 Powder pump, with software version starting from 1.13!

Product description

Field of application

OptiFeed PP06 powder pump

The OptiFeed PP06 Powder pump is intended for conveying coating powder (also enamel powder). Any other use is considered non-compliant. The manufacturer shall not be liable for damage resulting from such use; the user bears sole responsibility for such actions.

The OptiFeed PP06 Powder pump is suitable both for conveying fresh powder to automatic coating equipment and for general conveying of coating powders from powder hoppers.



OptiFeed PP06 powder pump

Utilization

The OptiFeed PP06 type power pump is designed to gently transport large quantities of powder, even over relatively large distances.

Conveyance

- Gentle conveyance of coating powders

Cleaning

- Powder hose emptying - prevents unintentional clogging
- Powder hose rinsing (two different programs) and filter element cleaning - makes the color change process more effective

Control

- Reception and processing of signals by the higher-level control (a PLC, for example)
- Processing of signals from a level sensor
- Control of a single-phase vibration motor (with the external power supply unit only)
- Maintenance interval monitoring - indicates upcoming maintenance
- Keyboard lock - prevents an unintentional manual intervention.
- Fluidization connection
- Connection for electric conveyance pressure monitoring
- Cyclical conveyance



Note:

The functions can be controlled manually or by a higher-level external control unit!

Reasonably foreseeable misuse

- Use of moist powder
- Insufficient fluidization at the suction point
- Operation without the proper training

Technical data

Powder output (guide values)

OptiFeed PP06 powder pump	
Hose length up to 8 m	5 kg/min
Hose length 8-16 m	4 kg/min
Hose length 16-25 m	3.5 kg/min

Electrical data

OptiFeed PP06 powder pump	
Nominal input voltage	24 VDC
Connected load	20 W
Protection type	IP54
Temperature range	0°C - +40°C (+32°F - +104°F)
Temperature class	T6

External power supply unit (option)	
Nominal input voltage (with vibrator operation)	110/230 VAC
Frequency	50/60 Hz
Output	20 VA (without AUX)
AUX power input	100 VA
Protection type	IP54
Temperature range	0°C - +40°C (+32°F - +104°F)
Temperature class	T6

Pneumatic data

OptiFeed PP06 powder pump	
Compressed air main connection	Quick release connection - 8 mm
Max. input pressure	8 bar
Min. input pressure	6 bar
Max. water vapor content of the compressed air	1,3 g/m ³
Max. oil vapor content of the compressed air	0.1 mg/m ³
Max. compressed air consumption during conveyance	12 Nm ³ /h

Dimensions

OptiFeed PP06 powder pump	
Width	255 mm
Depth	215 mm
Height	approx. 855 mm
Weight	13,5 kg

External power supply unit (option)	
Width	140 mm
Depth	220 mm
Height	200 mm
Weight	2.8 kg

Processible powders

OptiFeed PP06 powder pump	
Plastic powder	yes
Metallic powder	yes
Enamel powder (continuous duty)	OptiFeed PP06-E only

Sound pressure level

OptiFeed PP06 powder pump	
Normal operation	< 55 dB(A)
Cleaning operation mode	< 67 dB(A)

The sound pressure level was measured while the unit was in operation; measurements were taken at the most frequent operator positions and at a height of 1.7 m from the ground.

The specified value is applicable only for the powder pump itself and does not take into account external noise sources.

The sound pressure level may vary, depending on the powder pump configuration and space constraints.

Rating plate

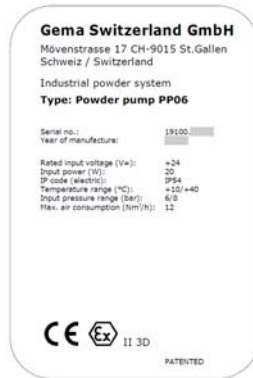

NOTE:

Fields with a gray background contain contract-specific data!

Design and function

General view

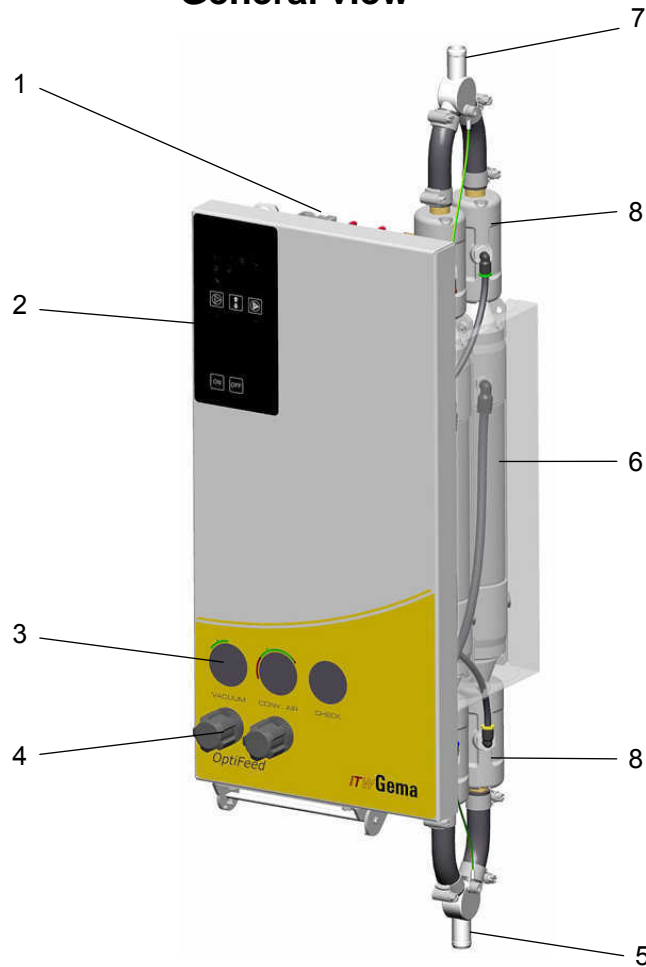

- | | | | |
|---|---------------------------|---|--------------------------------------|
| 1 | Connections | 5 | Conveyance side connection |
| 2 | Operating elements | 6 | Powder chambers with filter elements |
| 3 | Compressed air indicators | 7 | Suction side connection |
| 4 | Pressure regulator | 8 | Pinch valve |

Compressed air indicators



- | | |
|------------------|--------------------|
| VACUUM | Suction vacuum |
| CONV. AIR | Conveying air |
| CHECK | Process monitoring |

Operating elements

LEDs and input keys



Operating elements

Designation	Function
T1	ON key
T2	OFF key
T3	Rinse key
T4	Rinse direction change key
T5	Pump key

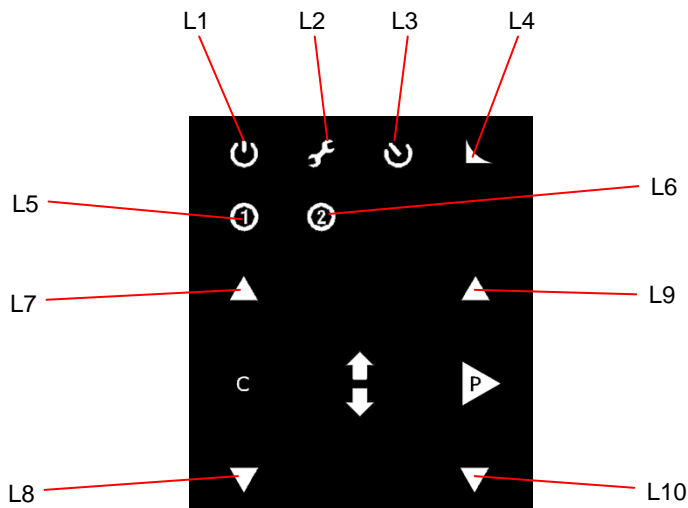

Designation	Function
L1*	ON / Programming mode / Remote operation indicator
L2*	Maintenance interval indicator
L3	Timer function indicator
L4	After-conveying indicator
L5	Rinse program 1 indicator
L6	Rinse program 2 indicator
L7, L8	Rinse direction indicator
L9, L10	Conveying direction indicator

* Multiple color display

Pressure regulator



- 1 Pressure regulator for adjusting the suction vacuum (VACUUM)
- 2 Pressure regulator for adjusting the conveying air (CONV. AIR)

Connections

Compressed air hoses (connections)

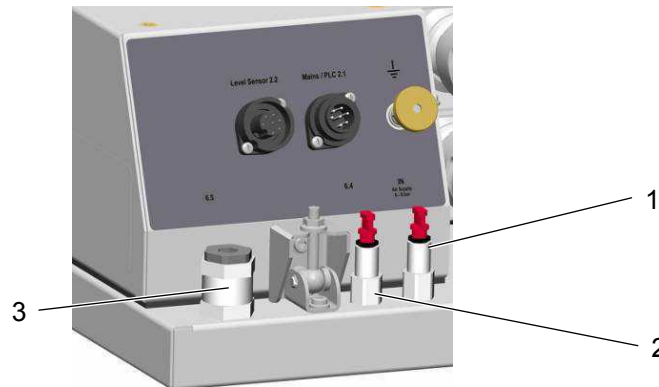

- 1 **IN** connection for compressed air supply
- 2 Connection **6.4** for fluidization (if necessary)
- 3 Connection **6.5** for pressure sensor (if necessary)

Powder hoses (connections)

A 16/23 mm-diameter powder hose is connection to the suction side and to the conveyance side.

Cables (connection and connection assignment)

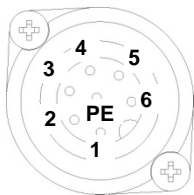

Mains/PLC 2.1 connection

- 1 +24 VDC
- 2 Pumps (see also section titled "Special functions")
- 3 Rinsing
- 4 +24 VDC output (max. load 100 mA)
- 5 Keyboard lock
- 6 Ground
- PE PE grounding

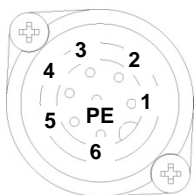

Level sensor 2.2 connection

- 1 Ground
- 2 +24 VDC level sensor
- 3 Signal (inverted)
- PE PE grounding

Internal design

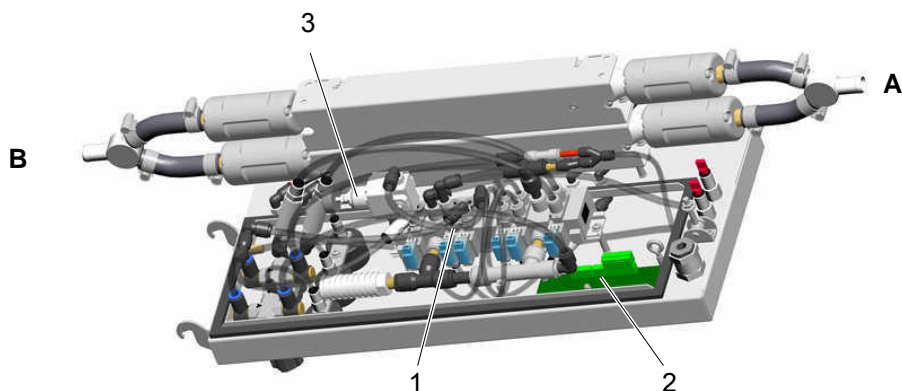

OptiFeed PP06 powder pump – internal design

A	Suction side	1	Pneumatic group
B	Conveyance side	2	Pump control unit
		3	Pressure regulator for pinch valves

Scope of delivery

- One OptiFeed PP06 Powder pump
- Connecting cable, 5 m
- Parts set (grounding cables, hose clamps, fuses)
- Quick-start guide and operating instructions

Available accessories

- Power supply unit with vibrator connection (110/230 VAC - 24 VDC)
- Retrofit set for fluid suction units
- LM02 level sensor with connecting cable
- Pressure sensor
- Hose connection for fluid suction units

Principle of operation

Suction procedure

In powder chamber 1, a vacuum (negative pressure) is produced. This vacuum aspirates the coating powder in the powder chamber. A fine-porous filter element (1) in the powder chamber separates the powder. The powder chamber is closed at the output side by a pinch valve (2).

Conveying procedure

The pinch valve (3) on the input side of the powder chamber 2 is closed, the pinch valve (4) on the output side is opened. The coating powder is pressed out of the powder chamber by overpressure, which is created with compressed air by the fine-porous filter element, and continued to convey.

The suction and the conveying procedure alternate between both powder chambers.

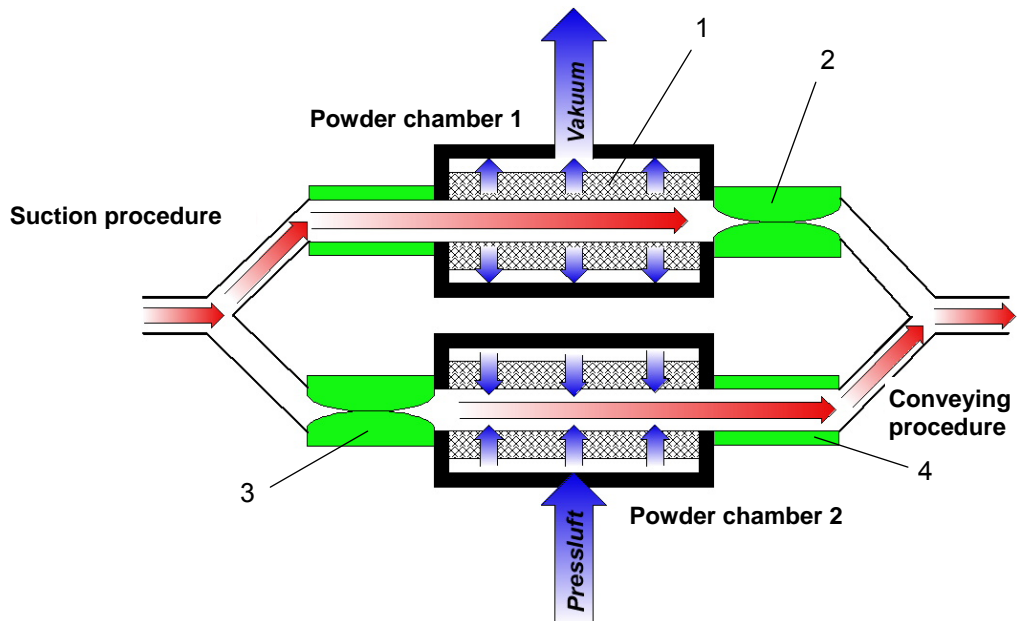

OptiFeed PP06 Powder pump – principle of operation

Typical properties – functional characteristics

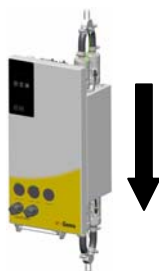

Conveying direction

The conveying direction of the OptiFeed PP06 powder pump is factory-preset in the direction of the arrow (see picture). If the powder pump has to convey in the other direction, the conveying direction can be changed.

To learn how to change the conveying direction, refer to the section titled "Initial start-up."



Note:

If the powder pump is positioned vertically, the factory-defined conveying direction must be set (suction side up/conveyance side down)!

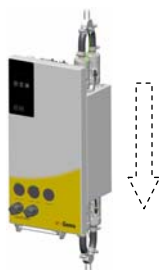

Powder hose emptying/after-conveying

The after-conveying avoids powder accumulations and cloggings in the powder hose. If the after-conveying is activated, after terminating the pump procedure, a few predefined pumping cycles will be executed without aspirating powder (recommended for powder tube lengths of over 2 m). The after-conveying is activated by factory.

To learn how to change the after-conveying, refer to the section titled "Initial start-up."



Powder hose rinsing

The powder hose rinsing enables the cleaning of the powder hoses and the filter elements in the powder pump. When changing colors, rinse the unit in both the conveying direction and the suction direction.

Changing the direction of powder hose rinsing

The direction of powder hose rinsing can be reversed manually or automatically.

See "Programming parameters."

Manual rinsing

This function is initiated manually. Rinsing takes place in the conveying direction or suction direction only.

Automatic rinsing

When the automatic rinsing function is activated by an external control unit (Control/PLC), the powder pump is rinsed automatically according to the rinse program setting.

Two rinse programs are available:

- **Rinse program 1** (factory-default rinsing of both powder chambers)



Note:

An additional external source of compressed air is mandatory for rinsing with rinse program 1! Such a source is provided if the PP06 comes supplied as part of a Gema system!

- **Rinse program 2** (rinsing in the suction direction or).

Level sensor signal delay

If the switching signal of a connected level sensor is applied, the conveying procedure is switched on with a delay to prevent the powder pump from switching on and off continuously.

The internal delay can be deactivated in the pump control (see "Programming parameters").

Maintenance interval monitoring

In order to offer assistance to the user, the OptiFeed PP06 powder pump indicates an upcoming maintenance. An orange LED  indicates maintenance is due. This does not affect function of the OptiFeed PP06 powder pump!

A red LED  means the pump should be serviced as soon as possible (see "Maintenance").

Resetting the maintenance interval monitoring

After the maintenance has been carried out, the maintenance interval monitoring can be reset (see "Maintenance").

Timer function

To prolong the service life of the pump parts, the pump should not be allowed to run continually in conveying mode. The timer function allows specific ON times and time periods to be programmed. This application is recommended especially when conveying used powder or waste powder.

See "Programming parameters."

Powder fluidization

The OptiFeed PP06 powder pump is equipped with a fluid connection (6.5). The air can be used to fluidize the powder in a fluidized powder hopper or it can be used locally for a fluid suction unit.



Note:

The equipment required for this can be ordered in consultation with Gema Customer Service.

Start-up

Preparation for start-up

Basic conditions

By the start-up of the OptiFeed PP06 Powder pump, the following basic conditions, which have an influence on the powder transport, must be considered:

- Length and height difference of the suction distance
- Length of the conveying distance
- Powder preparation and powder quality

The basics (preparation)

By following the basic principles below, you will be able to successfully start up your OptiFeed PP06 powder pump:

- Keep the suction distance as short as possible.
- At the suction area, ensure homogeneous fluidization so that no air pockets (craters) can be formed.
- Basically, the powder transport with the OptiFeed PP06 powder pump works with every powder type that can be fluidized. If the powder is, for example, humid or contaminated with other materials, then the conveying can be negatively influenced or may not work at all.

Set-up

The pump is used to convey fresh powder as well as recovered powder or waste powder.

The OptiFeed PP06 powder pump should always be mounted vertically.



NOTE!

A horizontal position will result in poor powder conveying performance.



WARNING:

The pump must not under any circumstances be set up near a heat source (such as an enameling furnace) or an electromagnetic source (such as a control cabinet).

Assembly guide

The OptiFeed PP06 powder pump is mounted with 4 M6 screws on the back.

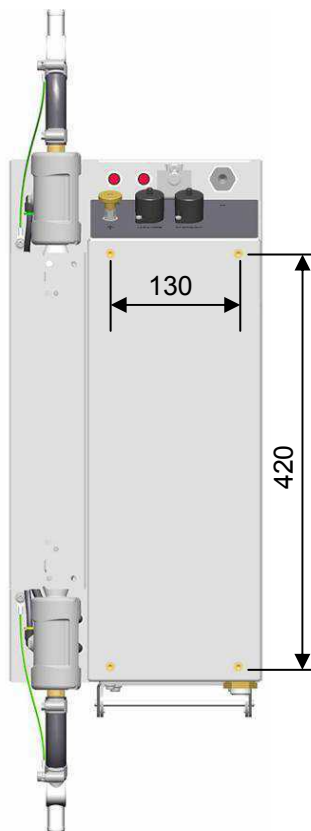

Assembly guide

Connection possibilities

Connection via the Mains/PLC 2.1 connection

The OptiFeed PP06 powder pump is powered with an operating voltage of 24 VDC via the **Mains/PLC 2.1** connection.



Connecting the external power supply unit

If the OptiFeed PP06 is used as a standalone unit or together with a vibration motor, the corresponding (optionally available) external power supply must be connected to the **Mains/PLC 2.1** connection.

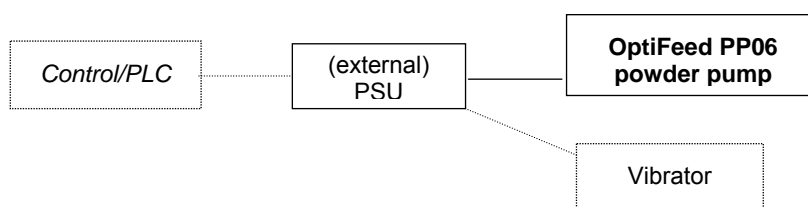

Connecting a level sensor

By connecting a level sensor on **Level Sensor 2.2**, the powder container level can be controlled with the powder pump.

If a level sensor is connected, a wake time can be activated/deactivated in the powder pump control unit. This wake time effects the after-conveying for 3 secs. after the achievement of the sensor switching point. This prevents the permanent switching on and off of the powder pump.



Level sensor connecting cable

A level sensor connecting cable is optionally available (see spare parts list).

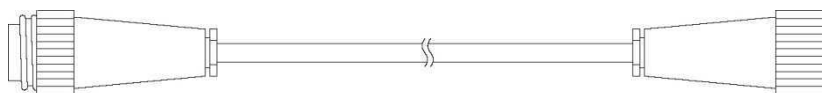

Level sensor connecting cable

Connecting the OptiFeed PP06 powder pump

As delivered by the manufacturer, the PP06 powder pump is ready for operation. Just a few cables and hoses must be connected.

The start-up takes place, depending on the powder pump control unit, according to following steps:

1. Connect the powder hoses to the powder pump input and output (default setting: output side down).

**Note:**

The powder pump parameters are preset at the factory (, rinse program, and after-conveying)!

- The "Programming parameters" section describes how to change these parameters!

-
2. Connect the fluidization to the connection **6.4** (if necessary)
 3. Connect the compressed air supply to the **IN Air Supply** connection.
 4. Connect the supplied grounding cable to the pump ground connection and to an appropriate grounding point.
 5. Connect the level sensor to the **Level Sensor 2.2** connection (if necessary).
 6. Connect the operating voltage via **Mains/PLC 2.1**.

**Note:**

If a vibration motor is used, it must be connection to the external power supply!

**Warning:**

Any unused electrical and pneumatic connections must be closed off. The sealing caps are in place when the unit is delivered!

Initial start-up



NOTE!

















The most recent settings are retained every time the powder pump is switched on.

Programming parameters



Conveying direction

The conveying direction of the OptiFeed PP06 powder pump is factory-preset in the direction of the arrow (see picture). To change the , follow these steps:

1. Press   for 5 seconds	 flashes,  lights up orange
2. Press 	 and  flash*,  lights up orange
3. Press 	 and  flash*,  lights up orange
4. Press  	 lights up  **  light up green







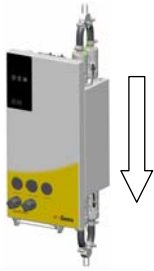









* Factory setting

** This symbol can light up either orange or red (depending on the status of the operating time).

Direction of powder hose rinsing



The powder hose rinsing of the OptiFeed PP06 powder pump is factory-preset in the (direction of the arrow; see picture). To change the rinse direction, follow these steps:

1. Press   for 5 seconds	 flashes,  lights up orange
2. Press 	 and  flash*,  lights up orange
3. Press 	 and  flash*,  lights up orange
4. Press  	 lights up  **  light up green

* Factory setting

** This symbol can light up either orange or red (depending on the status of the operating time).

After-conveying

The after-conveying function of the OptiFeed PP06 powder pumps is activated in the factory setting.

To disable this function, follow these steps:

1. Press  for 5 seconds	 goes dark
--	---

To activate this function, follow these steps:

2. Press  for 5 seconds	 lights up
--	---













After-conveying length

The after-conveying length is defined by the number of programmable cycles based on the hose length. The factory setting for the pump is 8 cycles.

These cycles are indicated by the corresponding LED when programmed:

 = 8 cycles (for powder hoses 2 m and longer)

 = 16 cycles (for powder hoses 25 m and longer)

1. Press   for 5 seconds	 lights up orange  lights up
2. Press 	 and  flash
3. Press 	 and  flash
4. Press  	 lights up green











Setting the rinse program

When the automatic rinsing function is activated by an external control unit (Control/PLC), the powder pump is rinsed automatically according to the rinse program setting.

Two rinse programs are available:



- Rinse program 1 (factory-default rinsing of both powder chambers)
- Rinse program 2 (rinsing in the suction direction or conveying direction).

Changing the rinse program



1. Press   for 5 seconds	 lights up orange  lights up
2. Press 	 flashes
3. Press 	 flashes
4. Press  	 lights up green

Level sensor delay

The internal delay is deactivated in the pump control as follows:

- | | |
|--|---|
| 1. Press  for 5 seconds |  and  flash |
|--|---|



The internal delay is activated in the pump control as follows:

- | | |
|--|---|
| 2. Press  for 5 seconds |  and  flash |
|--|---|



Timer function

Switching on

The timer function of the OptiFeed PP06 powder pump is deactivated in the factory settings To activate this function, follow these steps:

- | | |
|--|---|
| 1. Press  for 5 seconds |  lights up |
|--|---|

The timer function is deactivated in the pump control as follows:

- | | |
|--|---|
| 2. Press  for 5 seconds |  goes dark |
|--|---|

Setting the time period and ON time

Period	ON time			
	No. 1	No. 2	No. 3	No. 4
1 min.	20 sec.	30 sec.	40 sec.	50 sec.
6 min.	1 min.	2 min.	3 min.	4 min.
60 min.	2 min.	4 min.	6 min.	8 min.

1. Press for 5 seconds	lights up orange flashes
2. Press	, flash L9 flashes = period: 1 minute
3. Press	L10 flashes = period: 6 minutes
4. Press	L8 flashes = period: 60 minutes
5. Press	, flash L9 flashes = ON time 1
6. Press	L10 flashes = ON time 2
7. Press	L8 flashes = ON time 3
8. Press	L7 flashes = ON time 4
9. Press	

Restoring default values

1. Press	
2. Press and hold	
3. Press	All LEDs light up
4. Press and hold 5 seconds	Only the LEDs for the factory-preset functions light up

Manual operation



Note:

When installing or operating the pump for the first time, it is recommended to carry out a function check without powder!



Switching on the PP06 powder pump

The powder pump is switch on or off by pressing the **ON** key.

The  LED lights up green. The powder pump is ready for operation.

Manually starting the conveying procedure



Press



flashes*

The conveying procedure begins in the programmed conveying direction.

Manually stopping the conveying procedure



Press



flashes more quickly*

* Only if after-conveying is activated; otherwise, this LED lights up steady.

The conveying procedure is stopped.

When after-conveying is activated, the hose is emptied as it exits the pump (see section titled "Typical properties"). The LED first flashes more quickly, then lights up steady once the after-conveying procedure is finished.

* This is the factory-set conveying direction. The "Programming parameters" section describes how to change the conveying direction.

Manually starting the rinse procedure



Press



flashes*

The rinse procedure begins in the programmed rinse direction.

Manually reversing the rinse direction



Press



flashes

The rinse direction can be reversed at any time during the rinse procedure.

Manually stopping the rinse procedure



Press



lights up*

* This is the factory-set rinse direction. The "Programming parameters" section describes how to change the rinse direction.

Setting the suction and conveying parameters

Two pressure controllers are used to make these settings: **VACUUM** and **CONV. AIR**.

Setting the suction vacuum (VACUUM)

The required suction vacuum is set using the **VACUUM** pressure controller. The factory setting is 3 bar. Here are some recommended guide values:



Setting (bar)	Height difference (m)
2.0	0-1
3.0	2
4.0	3

Setting the conveying air (CONV. AIR)

The conveying air is set using the **CONV. AIR** pressure controller. The factory setting is 3 bar.

Recommendation:

- Do not fall below 2 bar, this can lead to cloggings
- Do not exceed 5 bar, if possible



Setting (bar)	Hose length (m)
2.0	up to 2
3.0	2-8
4.0	8-16
5.0	more than 16

Guide values for the conveying adjustment

Suction distance [m]	Conveying distance [m]	VACUUM [bar]	CONV. AIR [bar]	Powder hose emptying/ after-conveying activated
2	5	2	3	yes, recommended
2	25	2	5	yes, recommended
6	5	4	3	yes, recommended
6	25	4	5	yes, recommended
2	2	2	2	not necessary



Procedure monitoring (CHECK)

The **CHECK** pressure gauge enables the procedure monitoring. If the powder hose tends to clogging, then the pressure increases noticeably!



Note:

When the unit is operating properly, i.e., powder is being supplied to the pump normally, a pressure peak between 0.3-1.0 bar should be generated!

- ▶ During the pumping process, the pressure may not exceed 1 bar!

External control

Externally starting and stopping the conveying procedure



When the conveying procedure is started with external control, the  indicator flashes, and the  indicator lights up red.

The conveying procedure is ended by shutting off the external **Pump** signal.

When after-conveying is activated, the hose is emptied as it exits the pump (see section titled "Typical properties"). The  LED first **flashes** more quickly, then lights up steady once the after-conveying procedure is finished.



Externally switching the rinsing procedure on and off

Rinse program 1

When rinse program 1 is started with external control, the   indicators both flash at the same time, and the  indicator **lights up red**.

The rinse procedure is ended by shutting off the external **Rinse** signal.

Rinse program 2

When rinse program 2 is started with external control, the  and  indicators flash alternatingly for a specific time, and the  indicator **lights up red**.

The rinse procedure is ended by shutting off the external **Rinse** signal.

External control with level sensor

If the connected level sensor signals a lack of powder, the powder pump starts up either with a delay (by default) or immediately. The corresponding LED flashes during the delay time.



Note:

This delay can be deactivated (see section "LM02 Level sensor delay").

External control – summary

Inputs				Function
Pumping	Rinsing	Keyboard lock	Level sensor	
0	0	x	1	Pumping
1	0	x	0	Pumping
0	1	x	0	Rinsing
1	1	x	0	Reverse pumping
x	x	1	x	Keyboard lock

Start-up

The OptiFeed PP06 powder pump is started up for manual operation following these steps:

1. Ensure the grounding
2. Prepare the compressed air (6-8 bar)
3. Connect the 24 VDC electrical power supply (if using the vibrator: 110-230 VAC for the external power supply unit)
4. Switch on the OptiFeed PP06 Powder pump
5. Check the configuration of the pump control (see "Programming parameters")
6. Adjust the setting parameters for the suction procedure, suction distance, and height (see also section "Setting the suction and conveying parameters")
7. Start the pump procedure by pressing the **Pump** key
8. Optimize the setting parameters for the suction and conveying procedure



Note:

It is recommended to observe the pressure gauges of the pressure regulators. The indicators should be in the green range!

Decommissioning



1. Switch off the OptiFeed PP06 Powder pump by pressing the **OFF** key, or by switching off on the external control unit.
The  LED goes dark.
2. Cut off the compressed air supply to the powder pump!

Cleaning and maintenance



Note:

Regular, conscientious maintenance increases the service life of the OptiFeed PP06 powder pump and ensures the coating quality will remain consistent over a longer period of time!

- ▶ The parts to be replaced during maintenance work are available as spare parts. These parts can be found in the corresponding spare parts list!
-

Maintenance of the powder pump

The OptiFeed PP06 Powder pump is designed in such a way, that only a minimum maintenance must be carried out.

Daily maintenance

Clean the powder pump with a dry cloth and check the connection points of the powder hoses. Replace the powder hoses, if necessary.

Weekly maintenance

Rinse the powder pump in conveying direction and in suction direction by using the rinsing program. This cleans the filter elements and prevents potential, unintended powder deposits in the powder pump and in the powder hoses.

OptiFeed PP06 Powder pump – maintenance plan

The pinch valves on the OptiFeed PP06 powder pump are subject to a maintenance regime.



Warning:

A worn pinch valve hose, which becomes powder permeable, can damage the air valves!





Note:

The service life of the pinch valve hoses can be increased substantially if the timer functionality is activated!

Filter elements













The service life of the filter elements depends on the service duration, the powder quality and the quality of the air supply. Basically, it is recommended to replace also the filter elements by changing the pinch valves.

Maintenance according to maintenance interval monitoring

The OptiFeed PP06 powder pump indicates it is time for maintenance by changing the maintenance indicator from  to . If the recommended operating time is exceeded, the indicator changes to . As guide value, following operating times apply:

- 1 shift operation - after 360 days (continuous operation)
- 3 shift operation - after 120 days (continuous operation)

Resetting the maintenance interval

1. Press    for 5 seconds	 +  +  +  +  flash
2. Press   	 lights up

Maintenance set

The wearing parts to be replaced during the PP06 Powder pump maintenance are available as maintenance set (see the spare parts list). This set contains 2 filter elements, 6 fluid tubes, 8 O-rings (30 mm dia.), 4 O-rings (46 mm dia.) and 4 pinch valve hoses.

Replacing the pinch valves

Required spare parts - 4 pinch valve hoses NW15

Disassembly:

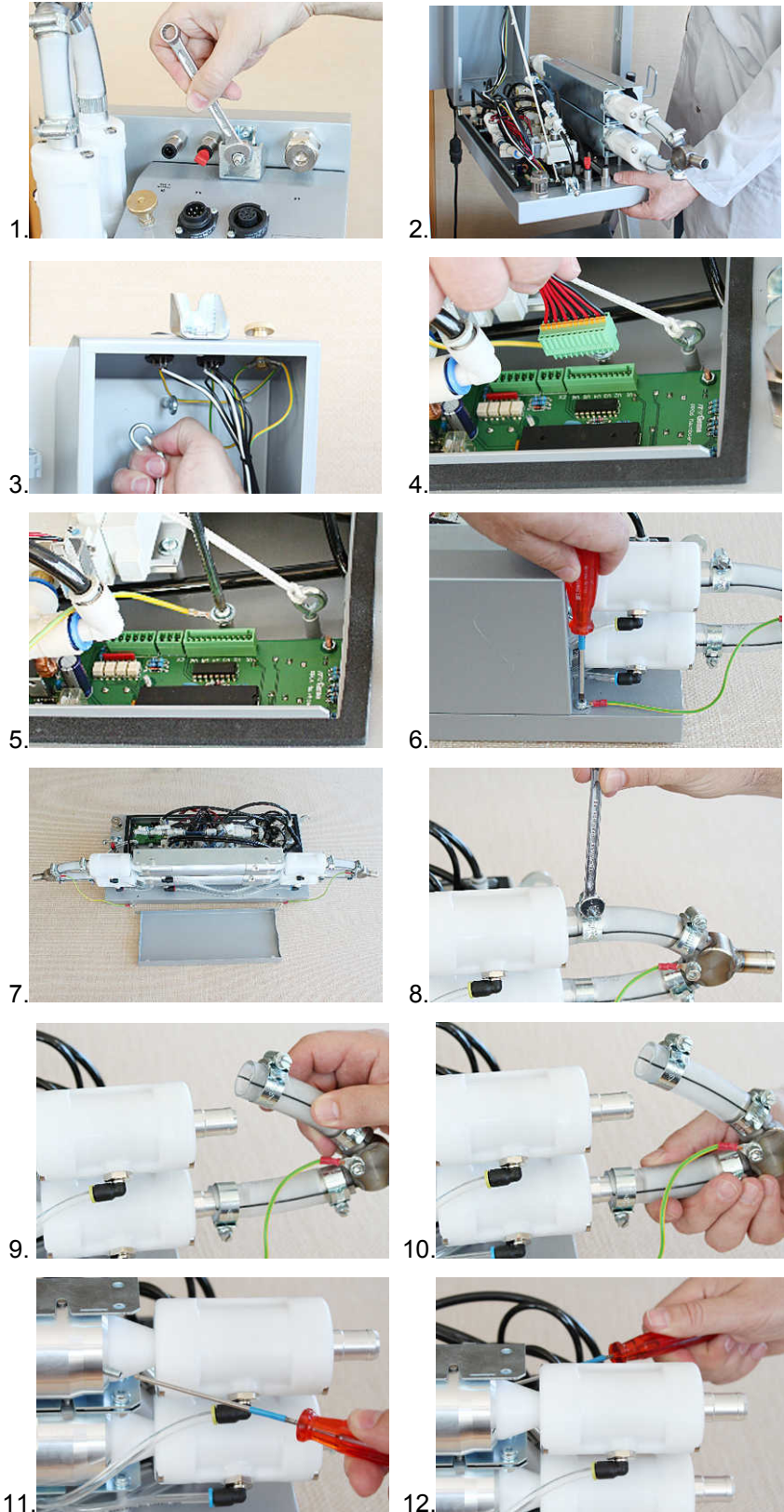



13.

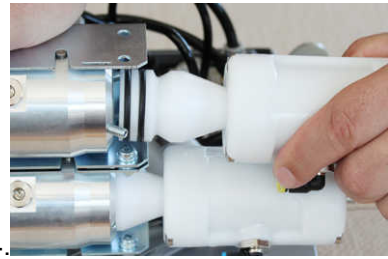

14.



15.



16.



17.

Replace

Assembly:



Note:

The assembly takes place in reverse order!

Soapy water

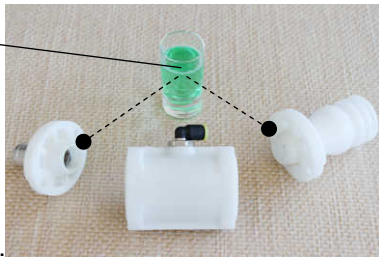

1.

2. Center the sleeve.

3. Tighten the screws evenly on both sides.

Replacing the filter elements

Required spare parts - 2 filter elements / O-rings if necessary

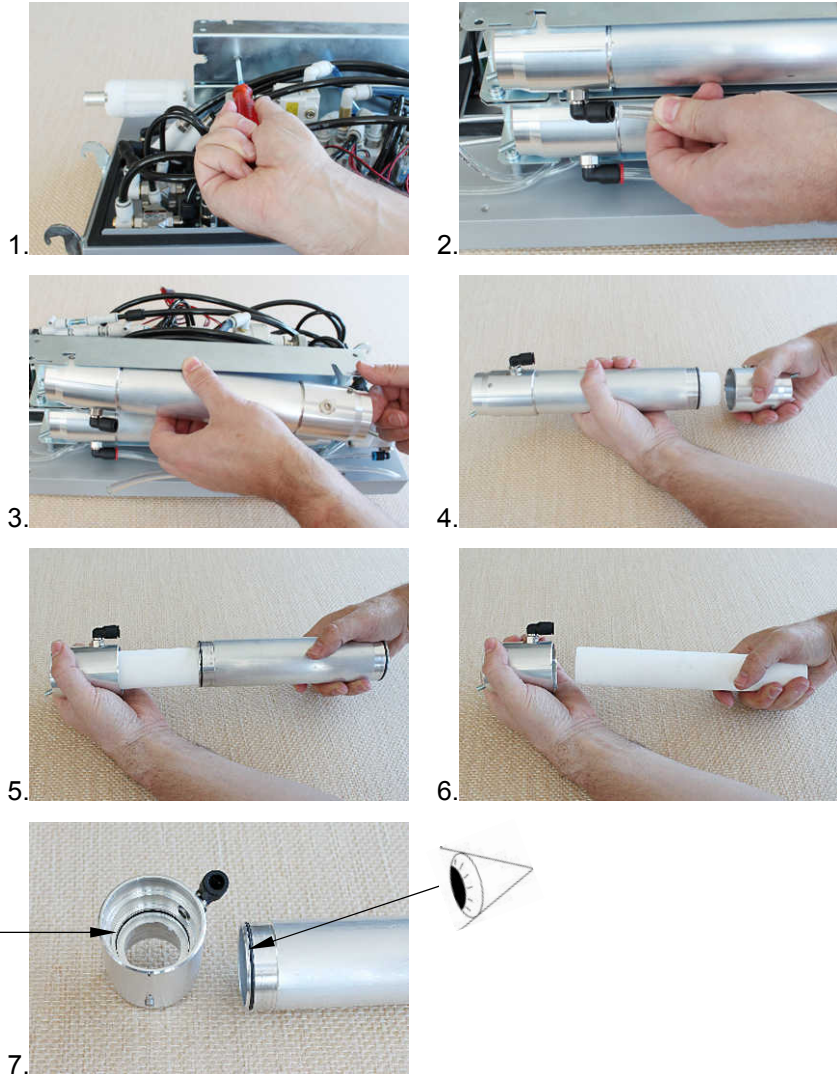









Note:

The assembly takes place in reverse order!

Corrective action

General information

Fault	Causes	Corrective action
 indicator on pump control unit does not light up	No operating voltage	+24 VDC must be supplied at connection 2.1 PIN 1
	Internal fusing is defective	Replace the defective fuse
	Pump control is defective	Replace pump control or send it in for repair
 and  indicator on pump control unit are flashing red	The parameter memory test was erroneous	Reset to the default values:  press for 5 seconds. Then set parameters, if necessary.
Powder pump is not conveying,  or  indicator is not flashing	No Pump on control signal	A control signal must be applied at connection 2.1 PIN 2
Powder pump is not conveying,  or  indicator is flashing	If the LEDs on the valve connectors do not light up, the pump control or corresponding valve is defective	Replace pump control or send it in for repair
		Replace the defective valve
Powder pump does not convey	Compressed air supply failed or pressure too low	Check the compressed air source (ensure an air pressure of 6-8 bar)
	No fluidization in the suction zone	Ensure the fluidization
	Conveying hose is clogged	Empty powder hoses over 6 m long with compressed air or manually (warning - powder will be expelled!)

Fault	Causes	Corrective action
	Suction hose is clogged	Run the rinse program in conveying and in suction direction (warning - powder will be expelled!)
	Service life of the pinch valve has expired (defective)	Change the pinch valve, check the pneumatic system for defects and replace, if necessary
Powder pump is not conveying adequately	The conveying hose or suction hose is becoming clogged	Empty the powder hose with compressed air or manually (warning – powder will be expelled!)
	Leaks on suction side	Check for leaks and reseal
	Filter elements in the powder chambers are not permeable enough	Replace the filter elements
	The filter tubes (protecting the pneumatics) are not permeable enough	Replace the filter tubes and check the pneumatic system for damage
	Wrong pinch valve pressure setting	On the internal pressure regulator set the pinch valve pressure to 3 bar (install a pressure gauge in the pneumatic line)

Service functions

Powder hose emptying before powder supply

An external starting impulse permits a powder hose emptying before the powder supply starts. When the signal is ending, the pump stops without overtravel cycle.

Timing diagram – Control/PLC 2.1 connection

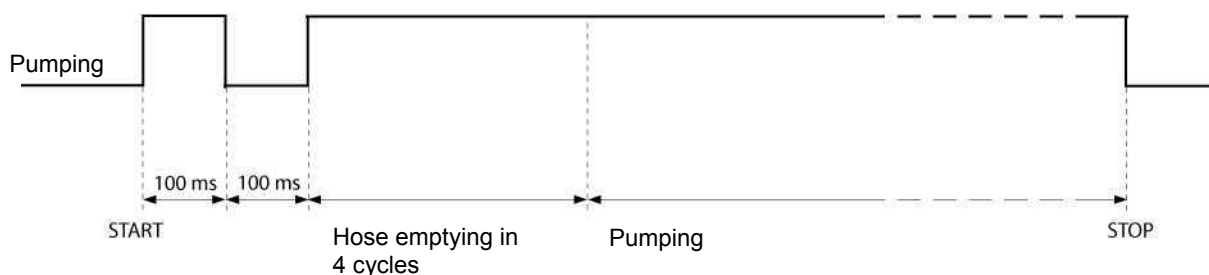

Timing diagram – Control/PLC 2.1 connection



Note:

After the signal drops off (STOP) if a start pulse (100 ms ON, 100 ms OFF, then ON) is applied again within 90 seconds, the pump begins conveying powder immediately (without emptying the hose).

Schematic diagrams

OptiFeed PP06 – block diagram

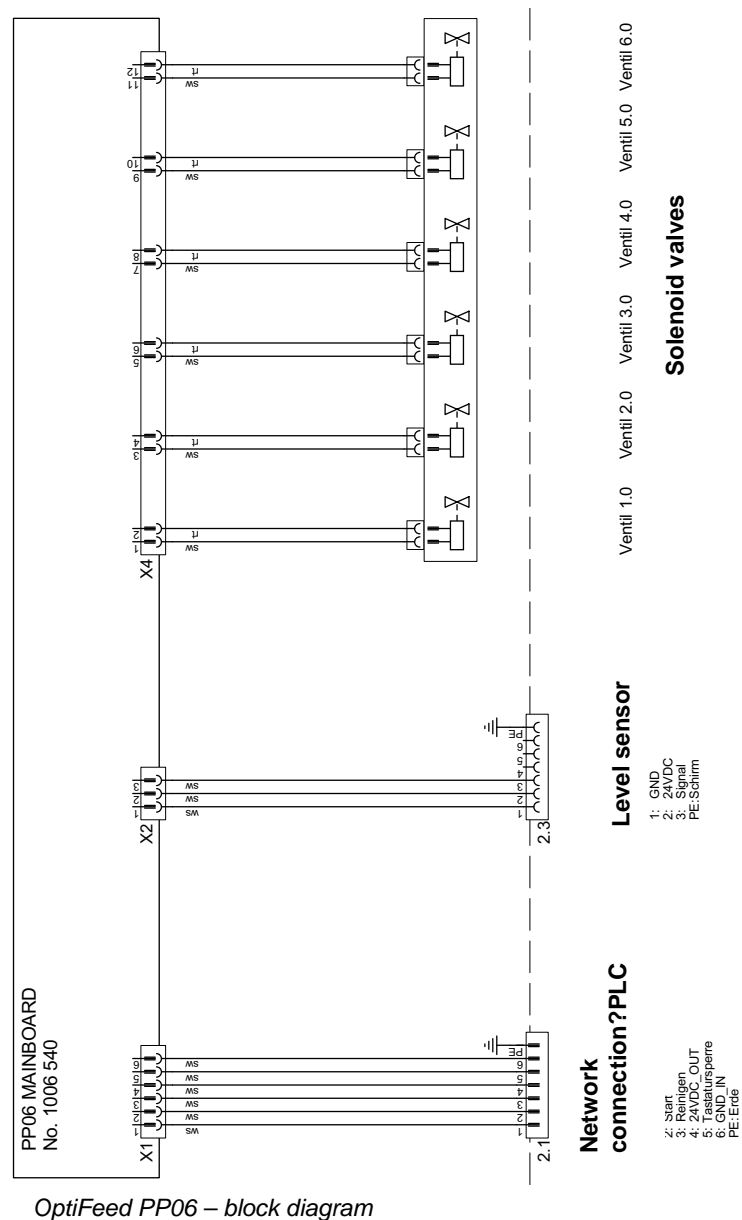

OptiFeed PP06 – block diagram

OptiFeed PP06 – pneumatic diagram

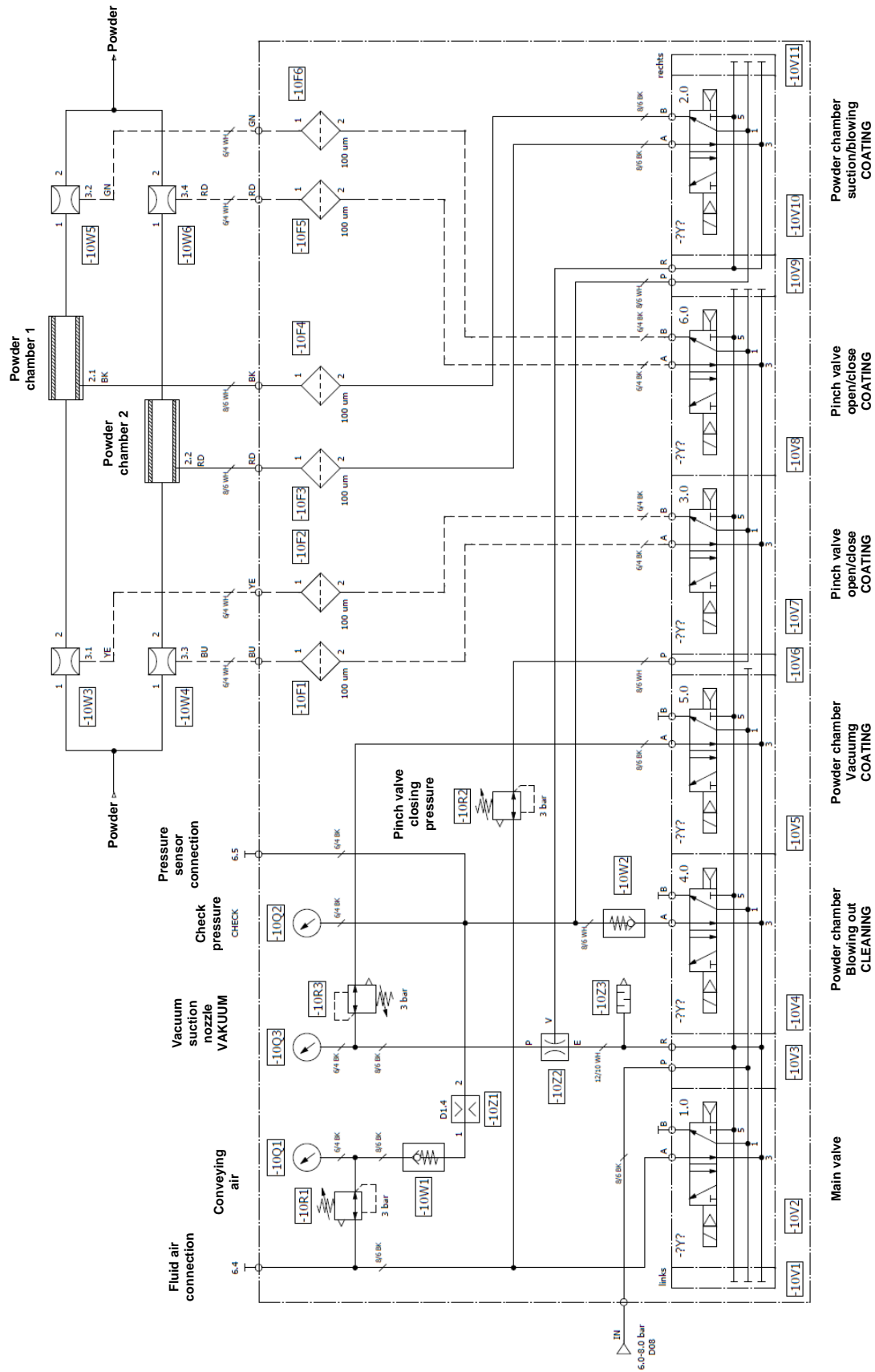

OptiFeed PP06 – pneumatic diagram

Spare parts list

Ordering spare parts

When ordering spare parts for powder coating equipment, please indicate the following specifications:

- Type and serial number of your powder coating equipment
- Order number, quantity and description of each spare part

Example:

- **Type** OptiFeed PP06 powder pump
Serial number 1234 5678
- **Order no.** 203 386, 1 piece, Clamp – dia.18/15 mm

When ordering cable or hose material, the required length must also be given. The spare part numbers of this yard/meter ware is always marked with an *.

The wearing parts are always marked with a #.

All dimensions of plastic hoses are specified with the external and internal diameter:

Example:

dia. 8/6 mm, 8 mm outside diameter (o/d) / 6 mm inside diameter (i/d)



WARNING:

Only original Gema spare parts should be used, because the explosion protection will also be preserved that way. The use of spare parts from other manufacturers will invalidate the Gema guarantee conditions!

OptiFeed PP06 powder pump

	OptiFeed PP06 powder pump – complete, with parts set, without powder hose	1006 245
	OptiFeed PP06-E powder pump – complete, with parts set, without powder hose	1007 680
1	Pneumatic group – complete (see corresponding spare parts list)	
2	Valve board – complete (without items 2.1, 2.2, 2.3)	1006 540
2.1	Spacer sleeve – dia. 3.1/6x15 mm	1006 987
2.2	Locknut – M3	262 498
2.3	Washer – dia. 3.2/7x0.5 mm	201 944
3	Connecting cable for valves	1006 967
4	Plug cap – dia. 8 mm	238 023
5	Powder chamber – see corresponding spare parts list	
6	Filter cartridge, complete – 8-8 mm	1006 670
7	Filter cartridge, complete – 8-6 mm (not shown)	1006 669
8	Pressure regulator – 0.5-8 bar, G1/8"	1006 241
9	Pressure gauge – 1 ... +9 bar - 1/8"	1005 827
10	Protection cap for connector socket	206 474
11	Protection cap for plug	206 458
12	Silencer – 1/2"	1006 969
	Connecting cable – L=5 m (not shown)	1003 651
	Connecting cable – L=30 m (not shown)	1004 112
	Connecting cable for LM02 level sensor – L=6 m (not shown)	1003 229

OptiFeed PP06 powder pump

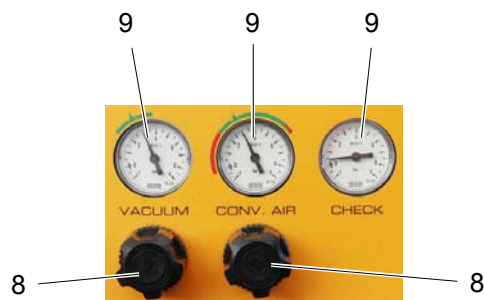
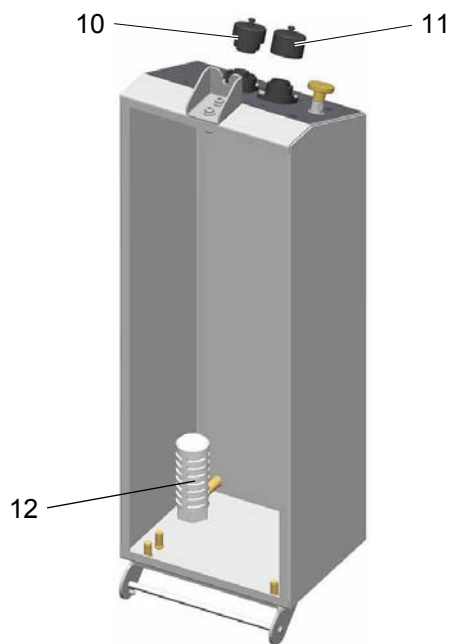
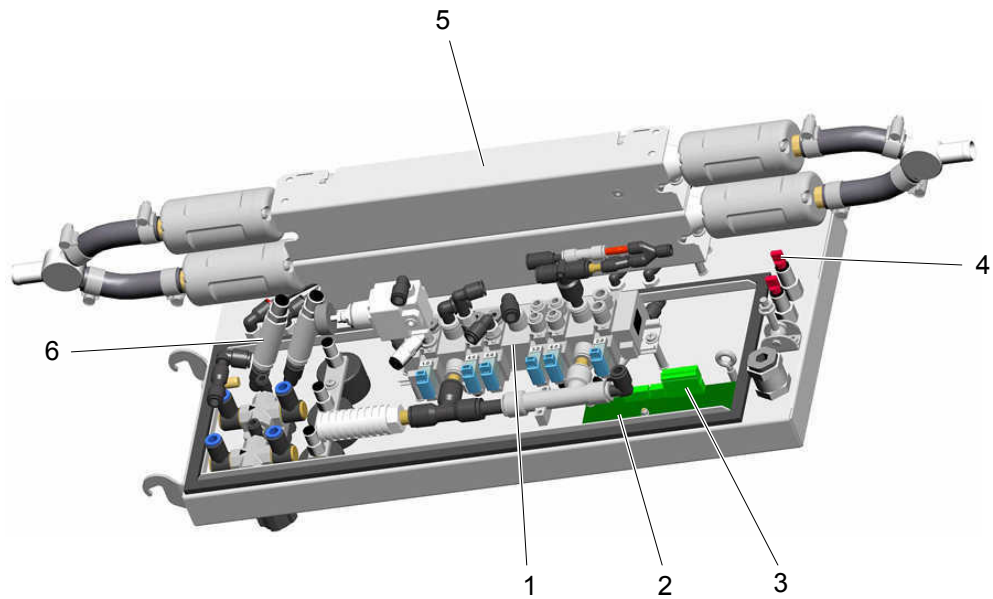

OptiFeed PP06 powder pump

OptiFeed PP06 powder pump – pneumatic group

1	End plate	1006 239
2	Solenoid valve	1006 237
3	Supply station	1006 234
4	Solenoid valve	1006 236
5	Auxiliary station	1006 235
6	Solenoid valve	1006 238
7	End plate	1006 240
8	Precision pressure regulator – 1/8", 0,5-8 bar	1006 986
9	Silencer – dia. 12 mm	1006 707
10	Vacuum generator	1006 242

OptiFeed PP06 powder pump – pneumatic group

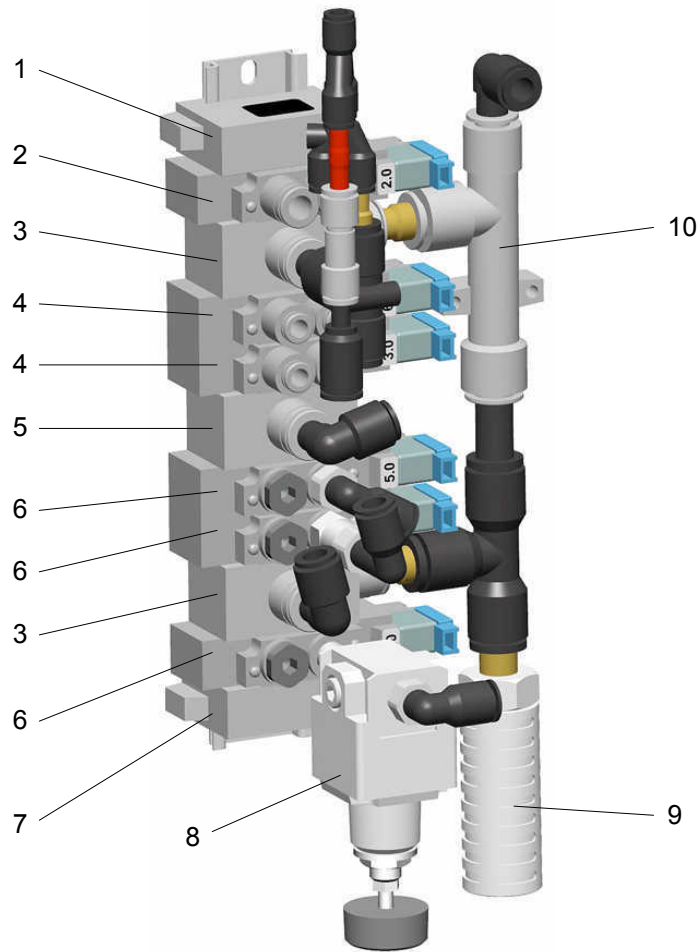

OptiFeed PP06 powder pump – pneumatic group

OptiFeed PP06 powder pump – powder chamber

A	Pinch valve – NW15 mm	1006 255
1	Hose connection – ID15	1003 301#
1.1	Hose connection – ID15 (Enamel version)	1006 591#
2	PT-screw – 50x25 mm	1003 558
3	Sleeve – NW15 mm	1006 256#
4	Elbow joint – 1/8"-6 mm	265 691
5	Connecting nipple	1006 495
5.1	Connecting nipple (Enamel version)	1006 493
6	O-ring – Ø 30x3 mm	1003 533#
7	Cone connection – complete, incl. Pos. 8 and 9	1006 254
7.1	Cone connection (Enamel version) – complete, incl. Pos. 8 and 9	1007 673
8	O-ring – Ø 39x3 mm	1006 278
9	Allen set screw – M5x12 mm	1006 498
10	Elbow joint – 1/8"– Ø 8 mm	251 372
11	O-ring – dia. 46x1.5 mm	1006 279#
12	Jacket tube	1006 251
13	Filter element – 40/30 mm	1006 252#
14	Sealing plug – 1/8"	263 826
15	Countersunk head screw – M5x10 mm	214 671
16	Y-piece	1006 962
17	Powder hose – Ø 16/23 mm	1010 040*#
17.1	Powder hose – Ø 16/23 mm (Enamel version)	1008 087*#
18	Hose clamp 17-25 mm	223 085
19	Grounding cable – complete	1006 990
20	Allen cylinder screw – M6x10 mm	216 399
21	Fan-shaped washer – A-type, M6	216 054
22	Cap screw – M5x12 mm	239 941
23	Fan-shaped washer – A-type, M5	231 045
24	O-ring – dia. 32x1.5 mm	1006 264#
	Maintenance set for PP06 powder pump (not shown)	1006 267

* Please indicate length

Wearing part

OptiFeed PP06 powder pump – powder chamber

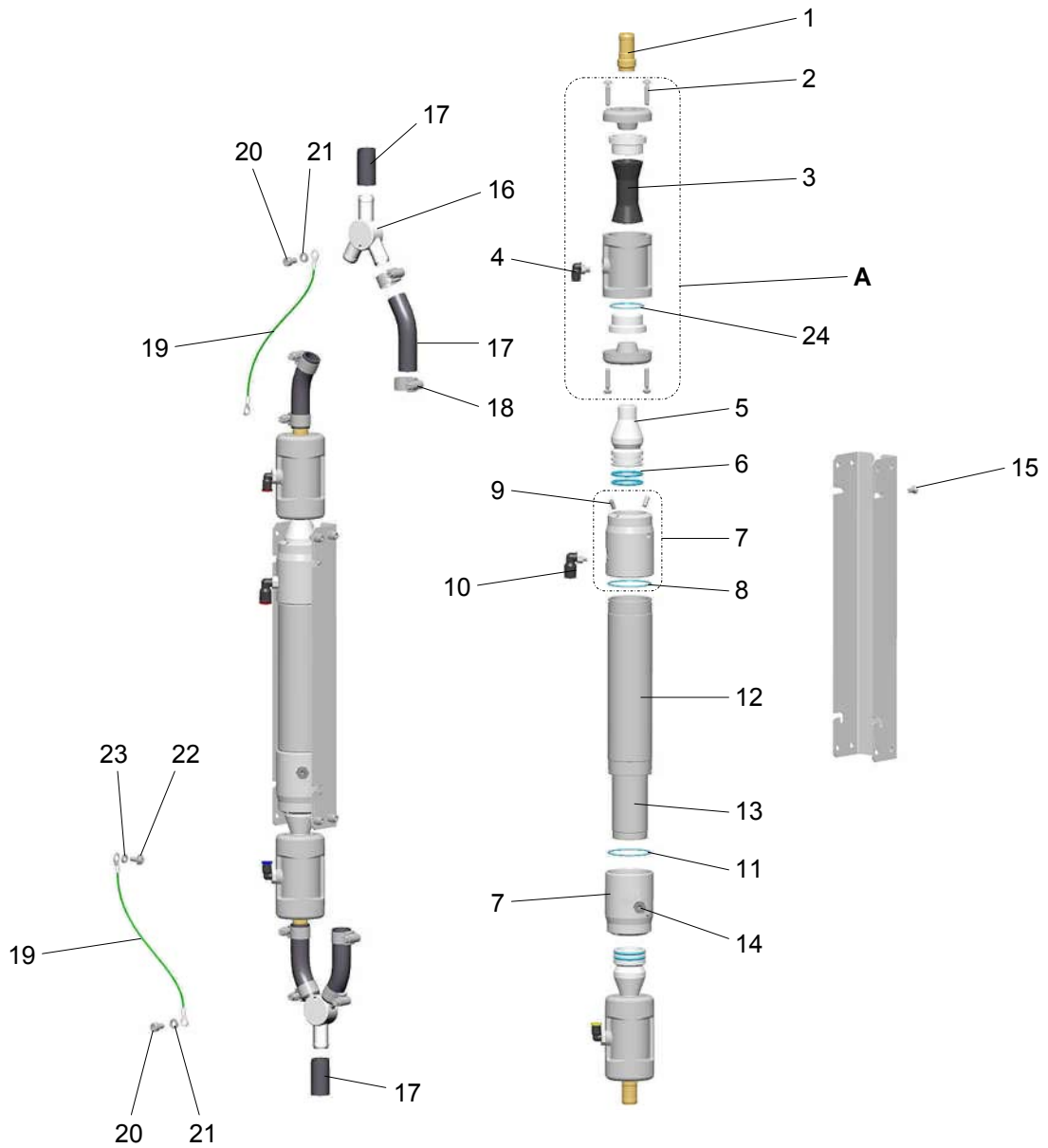

OptiFeed PP06 powder pump – powder chamber