

DEVILBISS®

EXL HVLP Siphon Feed Spray Gun

EXL HVLP Siphon Feed Spray Gun

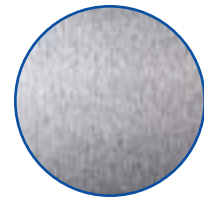
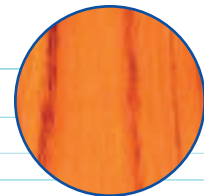
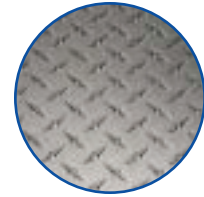

- Advanced technology for the professional painter
- Precision engineered #2000 air cap – Meets exacting performance demands, producing an extremely fine finish with all materials. Developed in conjunction with top American and European paint companies to spray the latest materials
- Large spray pattern for fast coverage
- Even distribution of materials for no mottling or striping – Excellent color matching capabilities
- Optimum atomization for clearcoats and single stages – Produces a high gloss finish and minimizes orange peel. Excellent fluid control for applying more film build with fewer passes
- Lightweight and comfortable – Classic DeVilbiss fit and feel
- Economical servicing – Air cap, fluid tips and needles are fully interchangeable and available separately
- Highly efficient HVLP design – Complies with environmental regulation requiring high volume, low pressure. Saves material. Very little overspray
- Low air pressure and volume requirements – GTI-5033-2000 Air Cap Test Kit (Order Separately) Provides consistent setup and regulatory proof of air cap pressure
- Stainless steel fluid tip, needle and fluid inlet

EXL HVLP Siphon Feed Spray Gun

Technical Specifications:

Model No.	Fluid Tip (mm)	Air Cap	Applications
EXL-520S-18	1.8	2000	Medium Viscosities 20-25 psi inlet pressure

Specifications:

30 psi inlet pressure delivers 10 psi air cap pressure at 16 cfm air volume

Refer to Service Bulletin: SB-2-496

EXL HVLP Siphon Feed Spray Gun

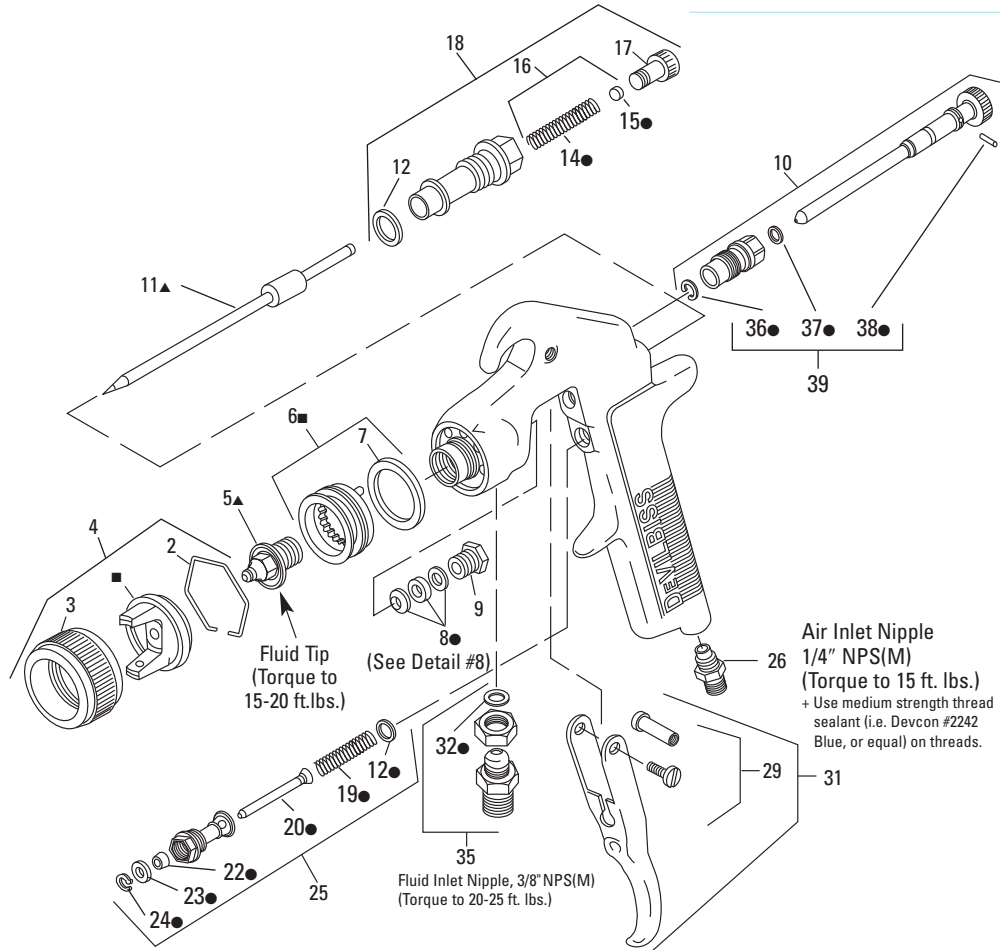
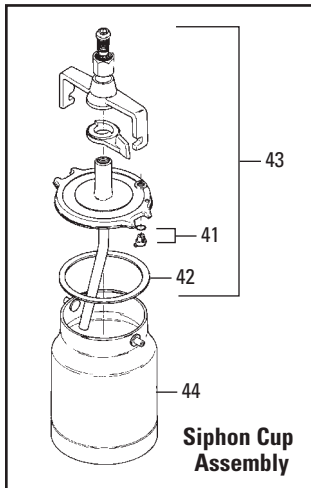
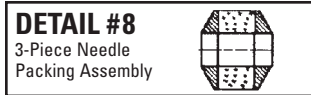
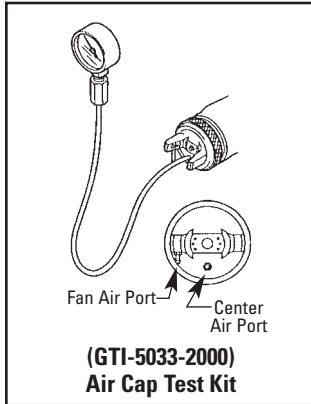

Customer Service 1.800.992.4657

Chart 1 Air Cap & Baffle Combinations

No. Stamped on Parts		Set		CFM@ Cap Pressure				
Air Cap Part No.	Baffle	Ref. No. 4 Air Cap	Ref. No. 7 Baffle Assy.	2 psi	4 psi	6 psi	8 psi	10 psi
2000	(Not Stamped)	GTI-407-2000	GTI-425	7.3	10.4	12.8	14.7	16

NOTE: Gun Repair Kit (KK-5058-2) Contains:

Ref. No.	Description	Qty.
6	Baffle Seal	1
8	Packing	1
12	Gasket Kit	2
14	Fluid Needle Spring	1
15	Spring Pad	1
19	Air Valve Spring	1
20	Air Valve	1
22	U Cup Seal	1
23	Washer	1
24	Snap Ring	1
32	Fluid Cup Gasket	1
36	Retaining Clip	1
37	Seal	1
38	Pin	1

Chart 2 Fluid Tips

Fluid Needle Model No.	Tip Size (I.D.)	
	In.	mm
GTI-413		
GTI-213-12	.047	1.2
GTI-213-13	.051	1.3
GTI-213-14	.055	1.4
GTI-213-15	.059	1.5
GTI-213-16	.063	1.6
GTI-213-18	.070	1.8
GTI-213-20	.079	2.0
GTI-213-22	.086	2.2

◆ Optional

DEVILBISS

DeVilbiss
195 Internationale Blvd.
Glendale Heights, IL 60139
630-237-5000
Fax 630-237-5011
www.devilbiss.com



Ref. No.	Model No.	Description	Ind. Parts Required
2	JGA-156-K10	Spring Clip (Kit of 10)	1
3	GTI-3	Air Cap Retaining Ring	1
4	See Chart 1	Air Cap and Retaining Ring	1
5	See Chart 2	Fluid Tip	1
6	See Chart 1	Baffle Assembly	1
7	GTI-33-K5	Baffle Seal (Kit of 5)	1
8	JGA-4035-K5	Packing (Kit of 5)	1
9	34411-122-K10	Packing Nut	1
10	GTI-405	Spreader Valve	1
11	GTI-413	Fluid Needle	1
12	JGS-72-K10	Gasket Kit (Kit of 10)	2
16	MBD-19-K10	Spring and Pad (Kit of 10)	1
17	GTI-414	Needle Adjusting Screw	1
18	KK-5059	Bushing, Spring, Pad and Knob Kit	1
25	JGS-449-1	Air Valve Assembly	1
26	P-MB-51	Air Inlet Nipple 1/4" NPS(M)	1
29	JGS-478	Stud and Screw Kit	1
31	JGS-477-1	Trigger Stud, Screw Kit	1
35	JGA-4042	Fluid Inlet, Gasket, Nut Kit	1
39	GTI-428-K5	Clip, Seal and Pin (Kit of 5 Each)	1
40	KK-5060	Air Cap Cleaning Kit (not shown)	1
41	TGC-407-1-K3	Drip Free Valve and Gasket (Kit of 3)	1
42	TGC-9-K5	**Tri Seal® Lid Gasket (Kit of 5)	1
43	TGC-404	Lid Assembly (Quart)	1
44	KR-428-2	Siphon Cup Assy. (Quart)	1
	TLC-40	Non Stick Siphon Cup Assy. (Quart)	

• (KK-5058-2) Gun Repair Kit includes a quantity of necessary parts.
Suffixes: -K5 designates kit of multiple parts. Example: JGA-4035-K5 is a kit of 5 packings.
* Registered Trademark of Tri-Seal International.